



Bullet Camera Series

Hardware Manual

E31A, E32A, E33A

E35, E36, E37

Ver. 2014/06/30



ACTi
Connecting Vision

Table of Contents

Precautions	4
Safety Instructions	6
Introduction	7
List of Models.....	7
Package Contents.....	8
Physical Description	9
Mounting Options	10
Installation Procedures Using the Bundled Bracket	11
Step 1: Install the Bundled Bracket.....	11
Step 2: Attach the Sunshield	12
Step 3: Install the Camera.....	13
Step 4: Waterproof and Connect the Cable	14
Using the Waterproof Tape.....	15
Using the Bundled Conduit Gland.....	16
Replacing the Pre-Installed Square-Shaped “Pigtail”	21
Step 5: Connect the Cable	25
Step 6: Access the Camera Live View.....	25
Other Adjustments and Accessories	26
How to Install / Remove the Memory Card	26
How to Insert the Memory Card	26
How to Remove the Memory Card.....	27
How to Reset the Camera.....	28
How to Adjust the Viewing Angle (Not available in E37).....	29
Accessing the Camera	30
Configure the IP Addresses	30
Using DHCP Server to Assign IP Addresses.....	30
Using the Default Camera IP Address.....	32
Access the Camera.....	34

Appendix

36

How to Make an Ethernet Cable 36

Precautions

Read these instructions

You should read all the safety and operating instructions before using this product.

Heed all warnings

You must adhere to all the warnings on the product and in the instruction manual. Failure to follow the safety instruction given may directly endanger people, cause damage to the system or to other equipment.

Servicing

Do not attempt to service this video device yourself as opening or removing covers may expose you to dangerous voltage or other hazards. Refer all servicing to qualified service personnel.

Trademarks

All names used in this manual are probably registered trademarks of respective companies.

Liability

Every reasonable care has been taken during the writing of this manual. Please inform your local office if you find any inaccuracies or omissions. We cannot be held responsible for any typographical or technical errors and reserve the right to make changes to the product and manuals without prior notice.

Federal Communications Commission Statement

This equipment has been tested and found to comply with the limits for a class B digital device, pursuant to Part 15 of the FCC Rules. These limits are designed to provide reasonable protection against harmful interference in a residential installation. This equipment generates, uses, and can radiate radio frequency energy and, if not installed and used in accordance with the instructions, may cause harmful interference to radio communications. However, there is no guarantee that interference will not occur in a particular installation. If this equipment does cause harmful interference to radio or television reception, which can be determined by turning the equipment off and on, the user is encouraged to try to correct the interference by one or more of the following measures:

- Reorient or relocate the receiving antenna.
- Increase the separation between the equipment and receiver.
- Connect the equipment into an outlet on a circuit different from that to which the receiver is connected.
- Consult the dealer or an experienced radio/TV technician for help.

Warning: Changes or modifications to the equipment that are not expressly approved by the responsible party for compliance could void the user's authority to operate the equipment.

European Community Compliance Statement

This product has been tested and found to comply with the limits for Class B Information Technology Equipment according to European Standard EN 55022 and EN 55024. In a domestic environment, this product may cause radio interference in which cause the user may be required to take adequate measures.

Safety Instructions

Don't open the housing of the product

Cleaning

Disconnect this video product from the power supply before cleaning.

Attachments

Do not use attachments not recommended by the video product manufacturer as they may cause hazards.

Water and Moisture

Do not use this video product near water, for example, near a bathtub, washbowl, kitchen sink, or laundry tub, in a wet basement, or near a swimming pool and the like.

Don't use accessories not recommended by the manufacturer

Only install this device in a dry place protected from weather

Servicing

Do not attempt to service this video product yourself as opening or removing covers may expose you to dangerous voltage or other hazards. Refer all servicing to qualified service personnel.

Damage Requiring service

Disconnect this video product from the power supply immediately and refer servicing to qualified service personnel under the following conditions.

- 1) When the power-supply cord or plug is damaged
- 2) If liquid has been spilled, or objects have fallen into the video product.
- 3) If the video product has been directly exposed to rain or water.
- 4) If the video product does not operate normally by following the operating Instructions in this manual. Adjust only those controls that are covered by the instruction manual, as an improper adjustment of other controls may result in damage, and will often require extensive work by a qualified technician to restore the video product to its normal operation.

Safety Check

Upon completion of any service or repairs to this video product, ask the service technician to perform safety checks to determine if the video product is in proper operating condition.









Introduction

List of Models

This hardware manual contains the following models:

E31A		1MP Bullet with D/N, Adaptive IR, Basic WDR, Fixed lens
E32A		3MP Bullet with D/N, Adaptive IR, Basic WDR, Fixed lens
E33A		2MP Bullet with D/N, Adaptive IR, Basic WDR, SLLS, Fixed lens
E34A		5MP Bullet with D/N, Adaptive IR, Basic WDR, Fixed lens
E35		3MP Bullet with D/N, Adaptive IR, Superior WDR, Fixed lens
E36		1.3MP Bullet with D/N, Adaptive IR, Basic WDR, SLLS, Fixed lens
E37		10MP Bullet with D/N, IR, Basic WDR, Fixed lens

Package Contents

Camera	Sunshield	Sunshield Screw Kit
		
Bracket	Bracket Plate	Lens Focus Tuner (not available in E37)
		
Conduit Gland	Quick Installation Guide	Warranty
		

Physical Description



NOTE: The shape of the Ethernet port on the actual camera may vary.

1) Memory Card Slot

Insert a memory card (not included) into this slot for local recording purposes. See [How to Install / Remove the Memory Card](#) on page 26 for more information.

NOTE: Supports microSDHC and microSDXC cards.

2) Reset Button

Use the Reset Button to reset the camera to its factory default settings. To do the reset, press and hold the Reset button for at least 5 seconds or until the Power LED lights up. When the Power LED lights up again, reset is complete. See [How to Reset the Camera](#) on page 28.

3) Power LED

The Power LED lights up when the camera is connected to the power source and goes off once the camera boot-up process is complete.

NOTE: For typical use, the power LED is hidden inside the housing and cannot be seen. However, knowing how the power LED works is essential when troubleshooting or doing a reset.





4) Ethernet Port

Connects to a network using an Ethernet cable.

Mounting Options

In areas with fierce weather conditions, the light bundled bracket can be replaced by a heavy duty outdoor bracket combined with additional mounting accessories.

Below are the optional mounting accessories that you can use with the camera.

Mount Types	Accessories		
Corner Mount	Suitable when mounting the camera on a corner wall.		
	PMAX-1103 	+	PMAX-0402 
Pole Mount	Suitable when mounting the camera on a pole.		
	PMAX-1103 	+	PMAX-0503 

NOTE:

- For more information about the mounting solutions and accessories, please check the [Mounting Accessory Selector](http://www.acti.com/mountingselector) in our website (<http://www.acti.com/mountingselector>).
- The above mounting accessories are not included in the package. Contact your sales agents to purchase.

Installation Procedures Using the Bundled Bracket

Step 1: Install the Bundled Bracket

1. Mark the location of the three (3) screw holes using the bracket plate included in the package.

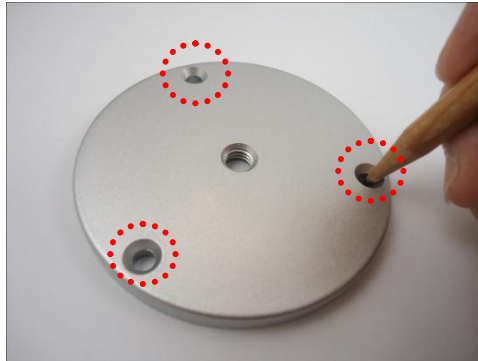

NOTE: Depending on the surface where you will install the camera, it may be necessary to drill the holes and use the supplied screw tool.

2. Attach the plate to the surface using the three (3) supplied screws.

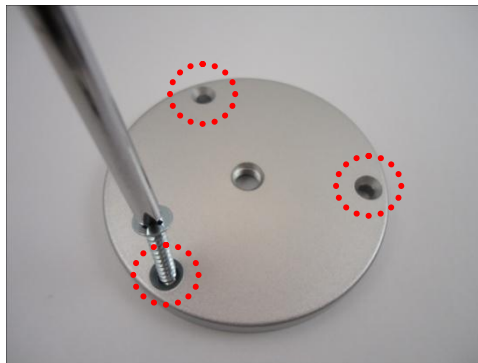

3. Attach the bracket to the plate.



Step 2: Attach the Sunshield

The use of sunshield is optional if the camera will be installed indoors. However, if the camera will be installed outdoors, attach the sunshield to protect the lens from all types of weather and lighting conditions.

1. Loosely secure the supplied screws and washers to attach the sunshield.



2. Slide to adjust the sunshield to cover the lens as far as possible but out of the camera's live view.



3. Tighten the screws to fix the position of the sunshield.

Step 3: Install the Camera

Before installing the camera, determine the most suitable method to waterproof the cable connection (see [Step 4: Waterproof and Connect the Cable](#) on page 14). Some methods may require the cable to be waterproof first before installing the camera to its bracket.

1. Depending on how you want to install the camera, attach the camera to the bracket through one of the two (2) holes below:



2. Adjust the camera viewing angle and tighten the knob to fix the camera position.

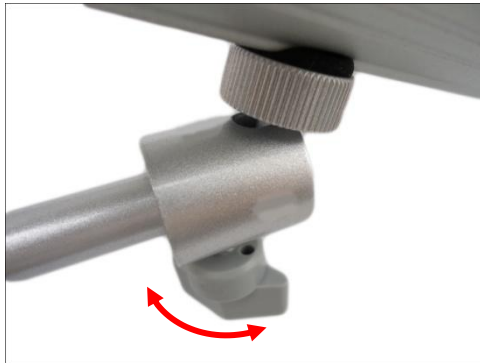

Step 4: Waterproof and Connect the Cable

If the camera will be installed indoors, simply connect the network side cable to the camera Ethernet port. No need to waterproof the cable connection. However, if the camera will be installed outdoors, check the type of Ethernet port and follow the applicable procedures to waterproof the cable connection.

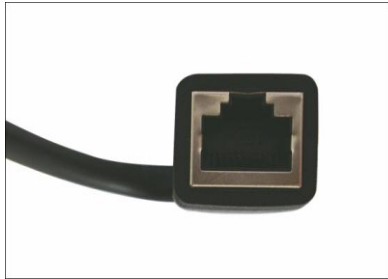
Type of Ethernet Port	Description
Square-Shaped 	<p>There are three (3) ways to manage and waterproof the square-shaped “pigtail”:</p> <ul style="list-style-type: none">• <i>Using the Waterproof Tape</i>, see page 15.• <i>Using the Bundled Conduit Gland</i>, see page 16. A flexible conduit (trade size ½”) is required to house the Ethernet cable.• <i>Replacing the Pre-Installed Square-Shaped</i> , see page 21.

Using the Waterproof Tape

Connect an Ethernet cable from the network side to the Ethernet port of the camera to complete the installation.

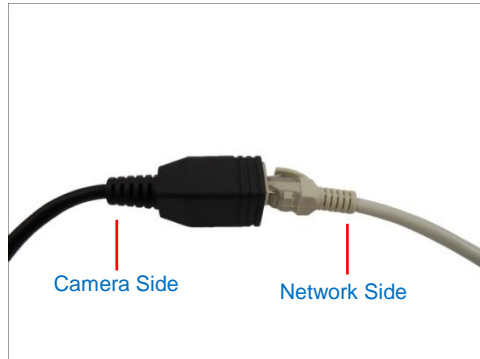

NOTES on using Ethernet cables: For outdoor installations, it is recommended to use *exterior-grade* Ethernet cables (CAT5/CAT5e/CAT6); ordinary Ethernet cables are only designed for indoor use and may deteriorate quickly when exposed to outdoor elements. Exterior-grade Ethernet cables are waterproof and do not require a conduit.



CAUTION: If the camera will be installed outdoors, be sure to waterproof the cable connection by enclosing it inside a junction box or wrap it using a moisture-sealant tape, such as **3M PRODUCTS Core Series 4-1000** (not included in the package) or equivalent. See example below.



Skip to **Step 5: Connect the Cable** on page 25.

Using the Bundled Conduit Gland

The camera and the pre-installed network cable are resistant to salt water, weak acid, alcohol, oil, grease and other common solvents. However, in areas with fierce weather conditions and those that can easily be flooded, ensure that the exposed length of cable is also protected.

It is recommended to use a flexible conduit with **1/2"** diameter and the conduit gland (included in the package) to protect the camera cabling. In this case, the pre-installed network cable with "pigtail" (female connector) must be replaced with a standard Ethernet cable



NOTE: The flexible conduit and Ethernet cable are not included in the package and must be sold separately. When purchasing, make sure the flex conduit size is 1/2" to match the bundled conduit gland.

To do the waterproof cable installation, also prepare the following tools:

- Screwdriver
- Wrench

Step 1: Remove the Pre-installed Network Cable (“Pigtail”)

1. Loosen the three (3) screws to detach the back cover.



NOTE: A cable is connected inside the camera; do not abruptly pull the back cover.

2. Disconnect the network connector.

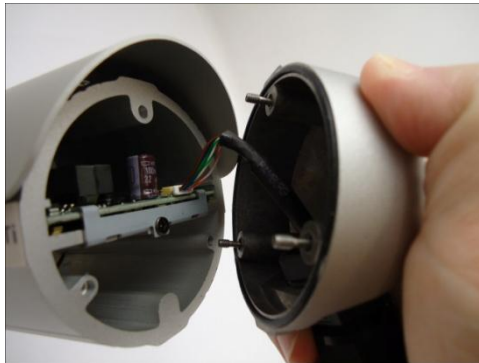

3. Remove the pre-installed cable gland and network cable using a wrench (not included in the package).



Step 2: Prepare the Conduit Gland and Flex Conduit

1. Disassemble the bundled conduit gland as shown below.

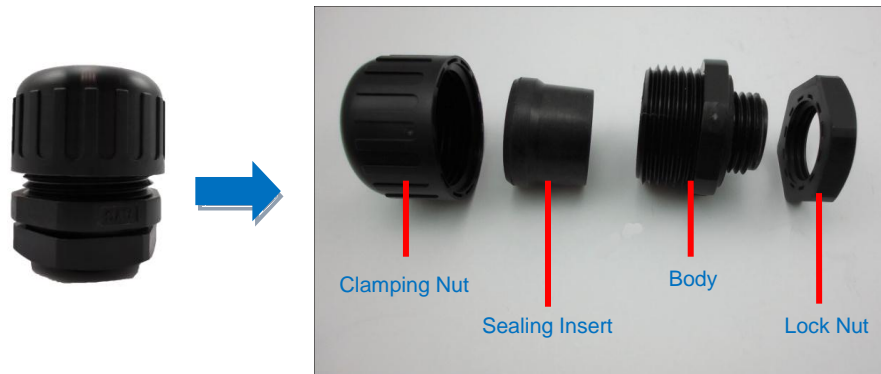

2. Pull the Ethernet cable through the flex conduit.



3. Insert the clamping nut through the flex conduit.



4. Insert the sealing insert and attach it at the end of the flex conduit.

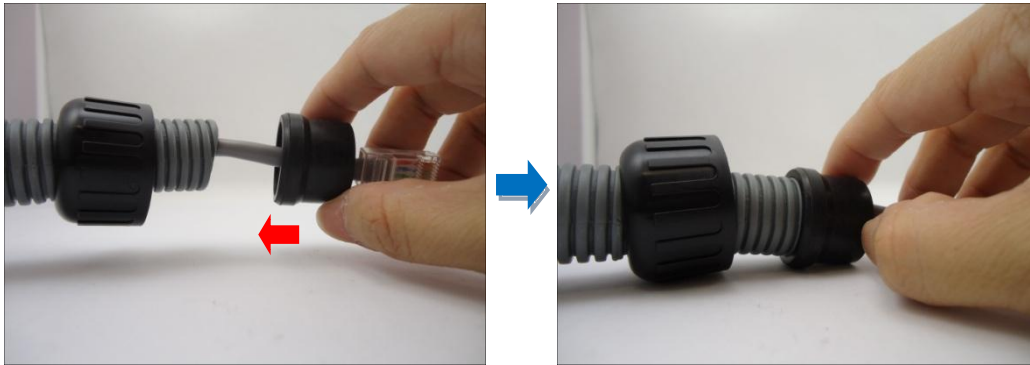

Step 3: Install the Ethernet Cable

1. Insert the body (A) to the back cover and secure it with the lock nut (B).

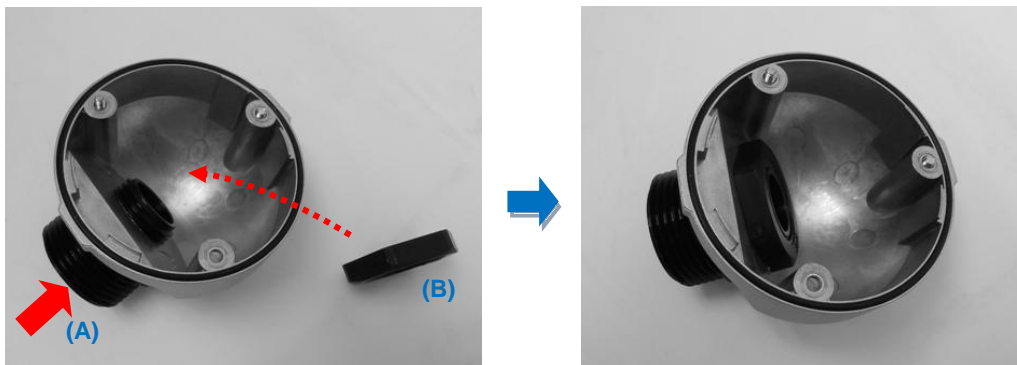

2. Insert the Ethernet cable through the back cover and then align the sealing insert to the gland body.

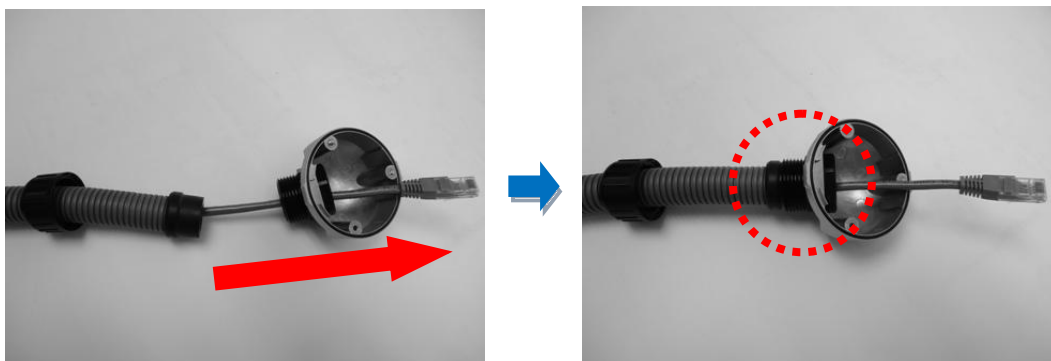

3. Secure the clamping nut to the body.



NOTE: Make sure the clamping nut is tight to avoid possible water leak.

Step 4: Connect the Ethernet Cable

1. Connect the Ethernet cable to the Ethernet port inside the camera.



2. When done, close the back cover by tightening the three (3) screws.

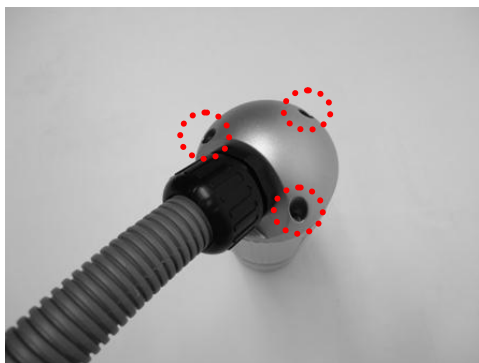

NOTE: Make sure the rubber ring on the cover is secured and the screws are completely tightened to avoid possible water leak.

Replacing the Pre-Installed Square-Shaped “Pigtail”

The pre-installed network cable comes with an Ethernet port (female connector), or known as a “pigtail”. The length of the cable is around 14 ~ 35 cm (varies by model). The network cable and gland are resistant to salt water, weak acid, alcohol, oil, grease and common solvents.

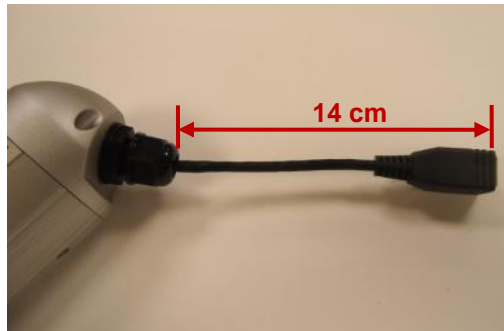

In case the installation environment requires a change of this network cable, follow the step-by-step procedures in this section to do so.

To replace the pre-installed network cable, prepare the following:

- Screwdriver
- Ethernet cable without connectors
- RJ-45 Connector (x2)
- RJ45 Crimping Tool

NOTE: The above materials/tools are not included in the package.

Step 1: Remove the Pre-installed Network Cable (“Pigtail”)

1. Loosen the three (3) screws to detach the back cover.

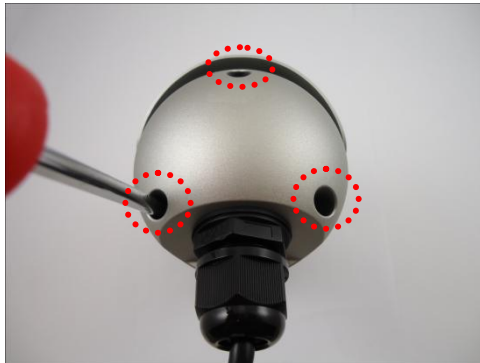

NOTE: A cable is connected inside the camera; do not abruptly pull the back cover.

2. Disconnect the network connector (A) and remove the sealing nut (B).

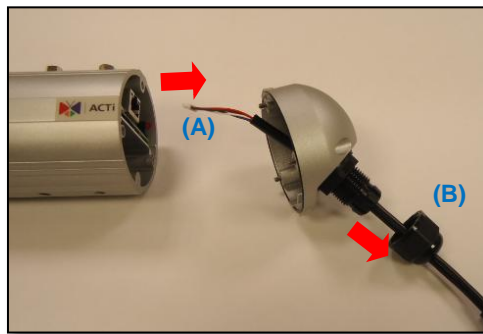

3. Pull out the network cable from the back cover and disassemble the parts as marked below.

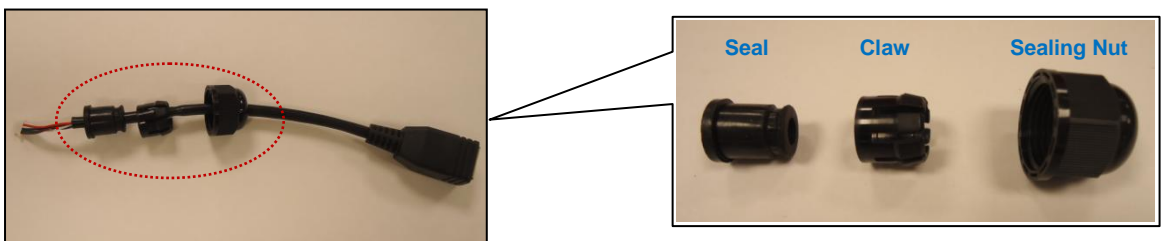

4. Squeeze the seal to pull out the connector and then completely remove the seal, claw, and sealing nut from the network cable.

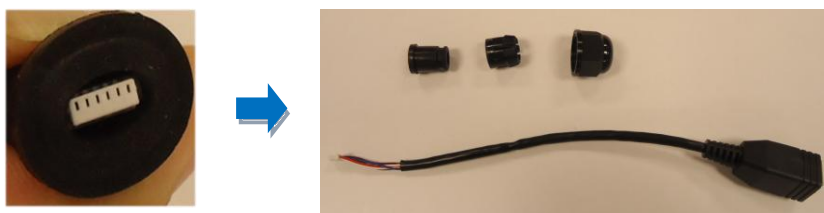

Step 2: Install the New Ethernet Cable

1. Insert the new Ethernet cable through the sealing nut, claw, seal, and cable gland of the back cover.

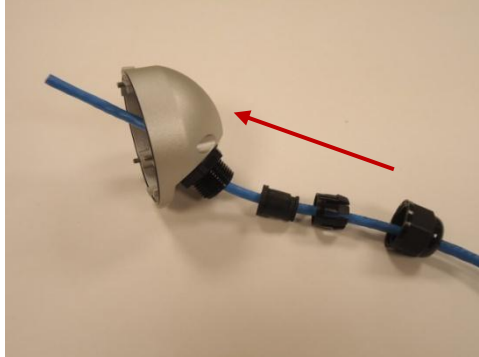

2. Attach the RJ-45 connector to the Ethernet cable. See [How to Make an Ethernet Cable](#) on page 36 for more information.
3. Assemble the seal and claw, and then connect the RJ-45 connector to the Ethernet port inside the camera.



4. Attach the back cover by tightening the three (3) screws.



NOTE: Make sure the rubber ring on the cover is secured and the screws are completely tightened to avoid possible water leak.

5. Tighten the sealing nut. Make sure the rubber is tightly squeezed to avoid possible water leak.



NOTES on using Ethernet cables: When replacing the pre-installed network cable, it is recommended to use *exterior-grade* Ethernet cables (CAT5/CAT5e/CAT6); ordinary Ethernet cables are only designed for indoor use and may deteriorate quickly when exposed to outdoor elements. Exterior-grade Ethernet cables are waterproof and do not require a conduit.

Step 5: Connect the Cable

Connect the other end of the network cable to a switch or injector. Then, connect the switch or injector to a network, PC, and a power source. See Power-over-Ethernet (PoE) connection example below.

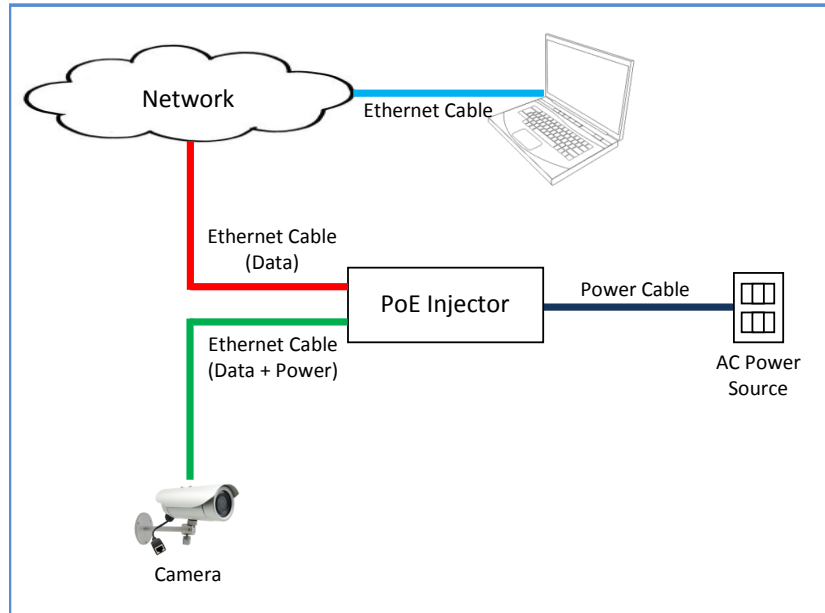

Step 6: Access the Camera Live View

See [Accessing the Camera](#) on page 30 for more information on how to access the Live View of the camera.

Other Adjustments and Accessories

This section describes the procedures on installing a memory card and resetting the camera.

How to Install / Remove the Memory Card

The camera supports local video recording or saving of snapshots to a memory card.

NOTE: Supports microSDHC and microSDXC cards.

How to Insert the Memory Card

4. Loosen the three (3) screws to detach the back cover.

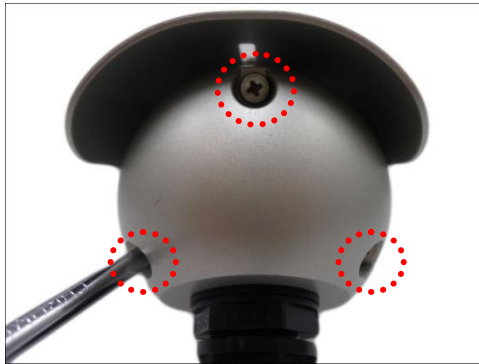

NOTE: A cable is connected inside the camera; do not abruptly pull the back cover.

5. Insert the memory card into the card slot with the metallic contacts facing down and push the card until it clicks into place.

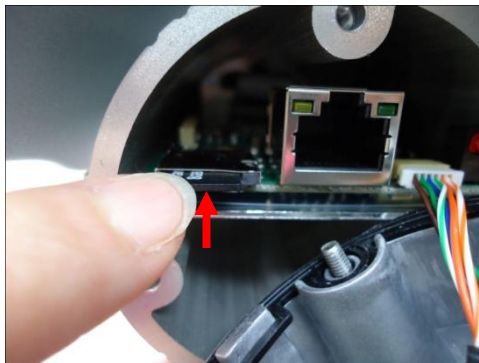

- When done, ensure the rubber seal is aligned and attached to the back cover and then close the back cover by tightening the three (3) screws.

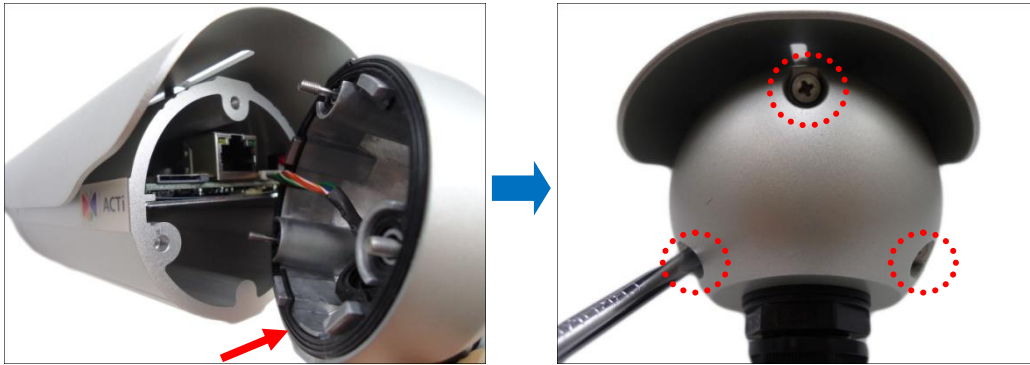

CAUTION: Make sure the rubber seal is properly attached and the back cover is closed to ensure water or dust cannot enter the camera.

How to Remove the Memory Card

In case there is a need to remove the card, make sure to access the camera Web Configurator to safely “unmount” the card first (see the camera Firmware manual for more information).

Once unmounted from the firmware, push the card to eject it from the slot.

How to Reset the Camera

In case there is a need to reset the camera to its default factory settings, do the following procedures while the camera is powered on.

5. Loosen the three (3) screws securing the back cover.

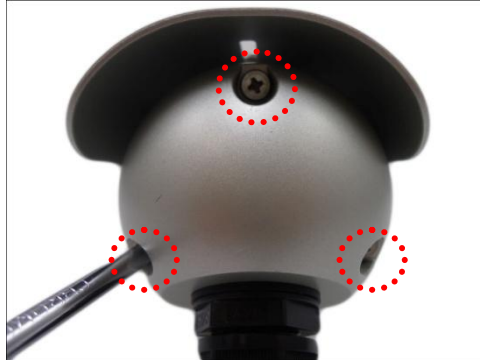

NOTE: A cable is connected inside the camera; do not abruptly pull the back cover.

6. Using a pointed object, such as the tip of a pen, press and hold the Reset button for at least 5 seconds or until the Power LED lights up, to reset the camera.



7. When done, ensure the rubber seal is aligned and attached to the back cover and then close the back cover by tightening the three (3) screws.

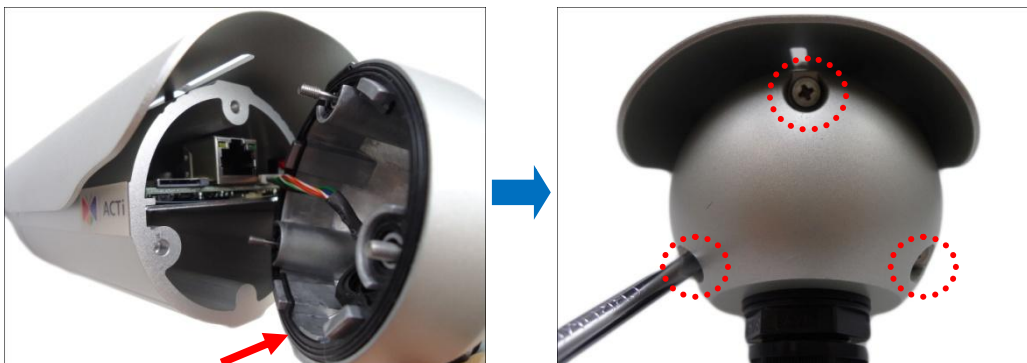

CAUTION: Make sure the rubber seal is properly attached and the back cover is closed to ensure water or dust cannot enter the camera.

How to Adjust the Viewing Angle (Not available in E37)

1. Open the front cover.



2. Attach the lens focus tuner to the lens.



3. Adjust the focus of the target area, based on the live view of the camera (see [Access the Camera](#) on page 34).



4. When done, close the front cover.

CAUTION: The front cover must be tightly closed to ensure water or dust does not go through any opening.

Accessing the Camera

Configure the IP Addresses

In order to be able to communicate with the camera from your PC, both the camera and the PC have to be within the same network segment. In most cases, it means that they both should have very similar IP addresses, where only the last number of the IP address is different from each other. There are 2 different approaches to IP Address management in Local Area Networks – by DHCP Server or Manually.

Using DHCP Server to Assign IP Addresses

If you have connected the computer and the camera into the network that has a DHCP server running, then you do not need to configure the IP addresses at all – both the camera and the PC would request a unique IP address from DHCP server automatically. In such case, the camera will immediately be ready for the access from the PC. The user, however, might not know the IP address of the camera yet. It is necessary to know the IP address of the camera in order to be able to access it by using a Web browser.

The quickest way to discover the cameras in the network is to use the simplest network search, built in the Windows system – just by pressing the “Network” icon, all the cameras of the local area network will be discovered by Windows thanks to the UPnP function support of our cameras.

In the example below, we successfully found the camera that we had just connected to the network.

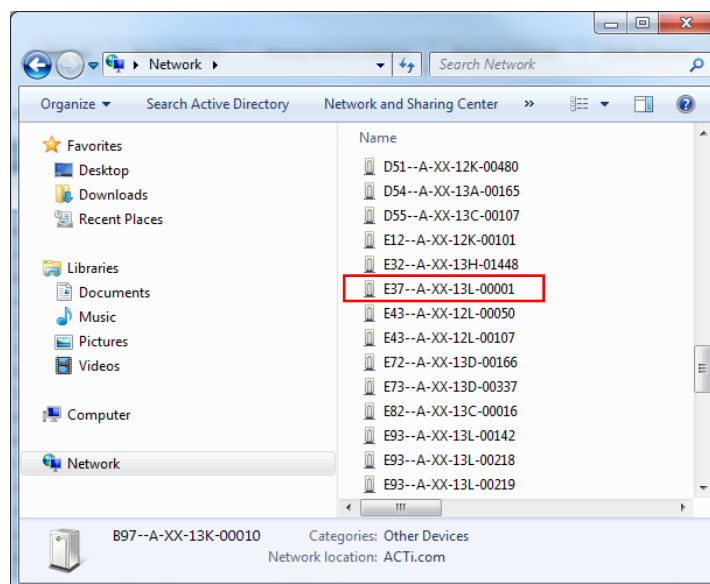

By double-clicking with the left mouse on the camera model, it is possible to automatically launch the default browser of the PC with the IP address of the target camera filled in the address bar of the browser already.

If you work with our cameras regularly, then **there is even a better way to discover the cameras in the network** – by using **IP Utility**. The IP Utility is a light software tool that can not only discover the cameras, but also list lots of valuable information, such as IP and MAC addresses, serial numbers, firmware versions, etc, and allows quick configuration of multiple devices at the same time.

The IP Utility can be downloaded for free from http://www.acti.com/IP_Utility

With just one click, you can launch the IP Utility and there will be an instant report as follows:

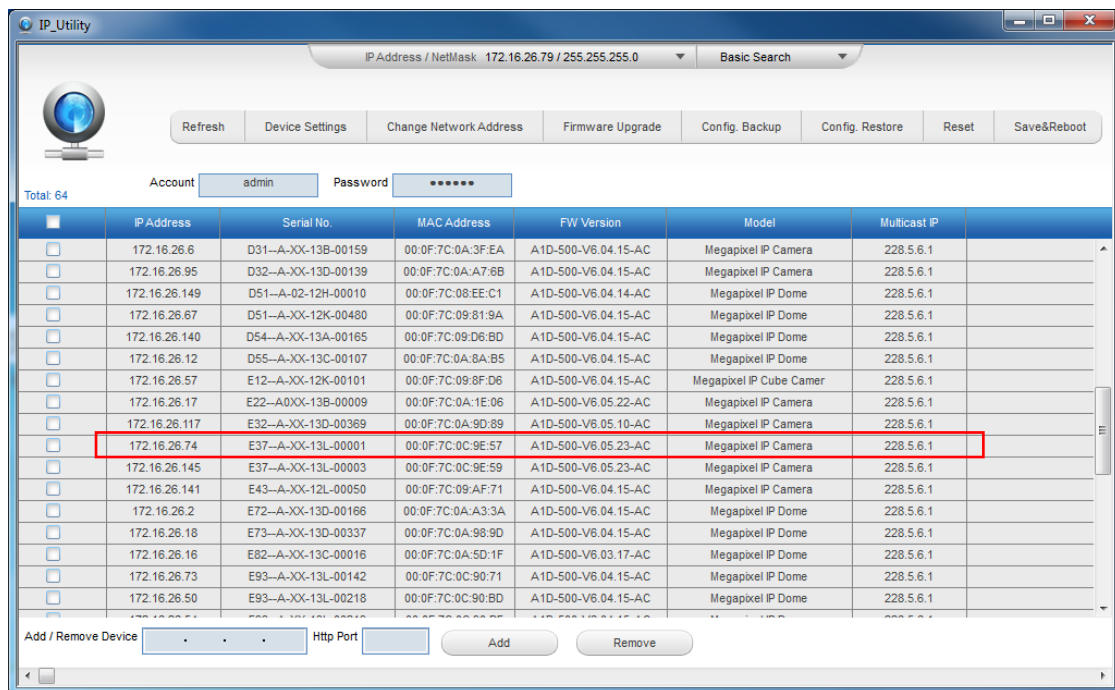

You can quickly see the camera model in the list. Click on the IP address to automatically launch the default browser of the PC with the IP address of the target camera filled in the address bar of the browser already.

Using the Default Camera IP Address

If there is no DHCP server in the given network, the user may have to assign the IP addresses to both PC and camera manually to make sure they are in the same network segment.

When the camera is plugged into network and it does not detect any DHCP services, it will automatically assign itself a default IP:

192.168.0.100

Whereas the default port number would be **80**. In order to access that camera, the IP address of the PC has to be configured to match the network segment of the camera.

Manually adjust the IP address of the PC:

In the following example, based on Windows 7, we will configure the IP address to **192.168.0.99** and set Subnet Mask to **255.255.255.0** by using the steps below:

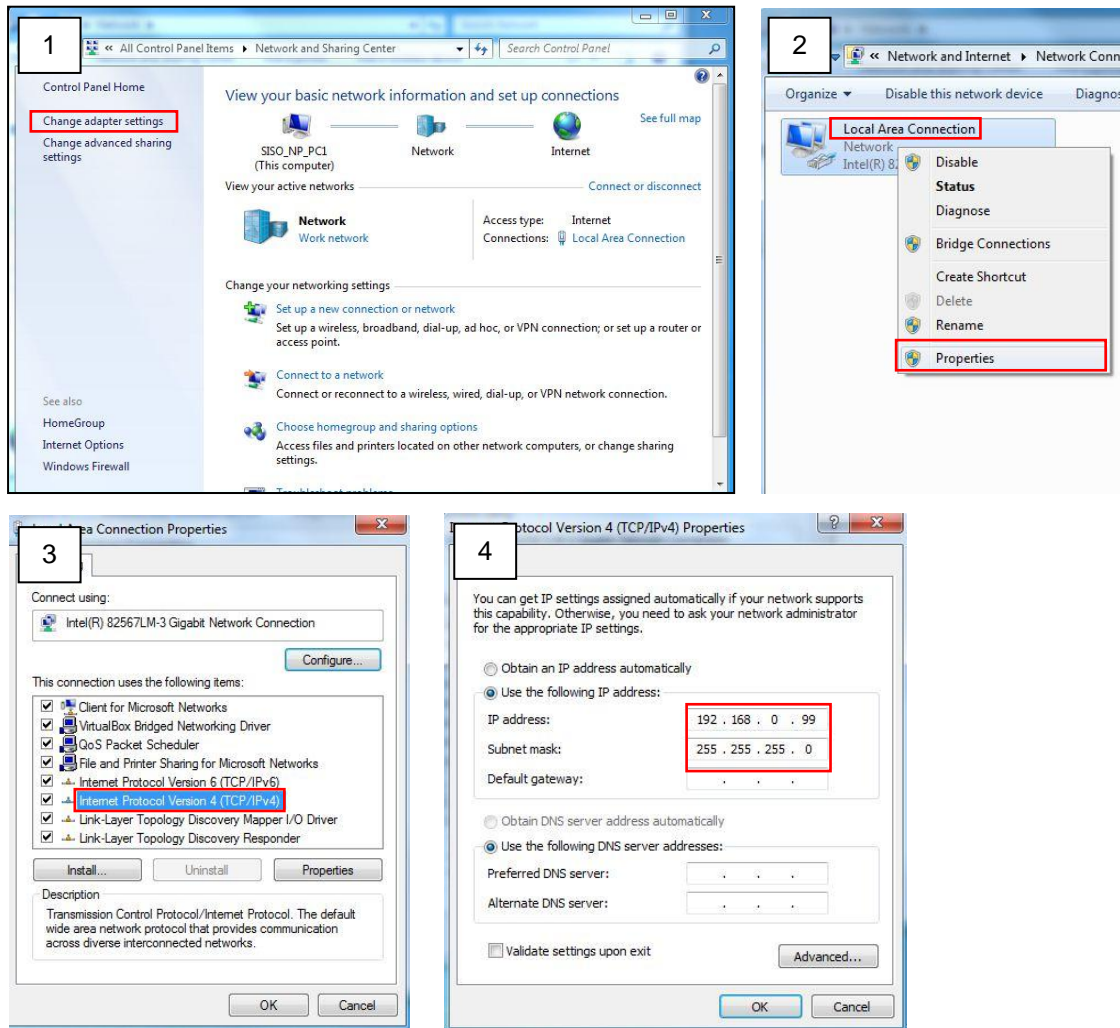

Manually adjust the IP addresses of multiple cameras:

If there are more than one camera to be used in the same local area network and there is no DHCP server to assign unique IP addresses to each of them, all of the cameras would then have the initial IP address of **192.168.0.100**, which is not a proper situation for network devices – all the IP addresses have to be different from each other. The easiest way to assign cameras the IP addresses is by using **IP Utility**:

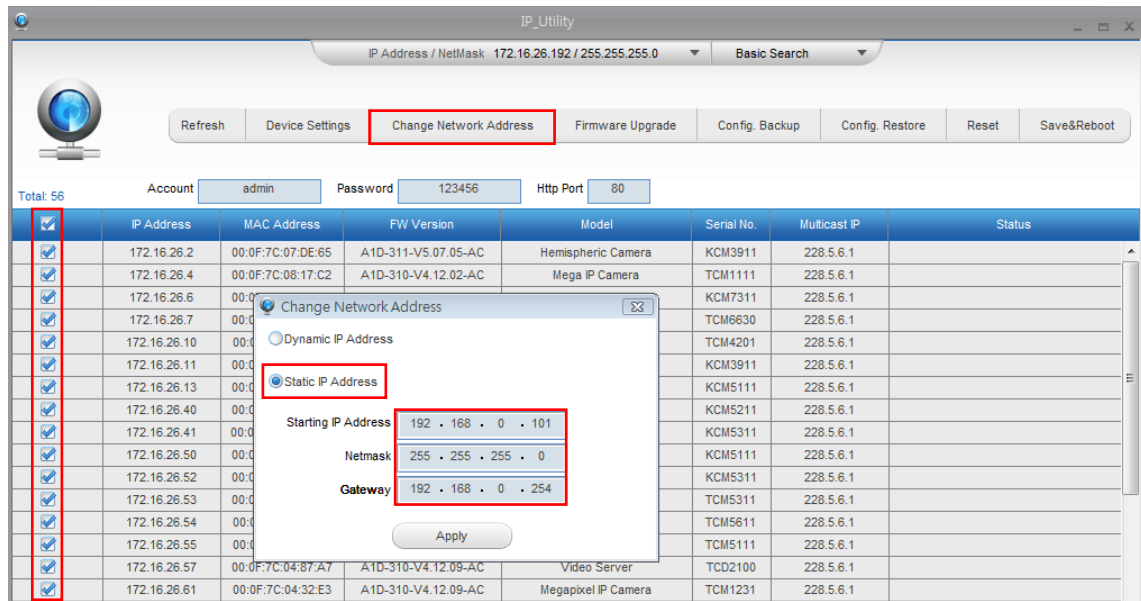

With the procedure shown above, all the cameras will have unique IP addresses, starting from 192.168.0.101. In case there are 20 cameras selected, the last one of the cameras would have the IP 192.168.0.120.

Later, by pressing the “Refresh” button of the IP Utility, you will be able to see the list of cameras with their new IP addresses.

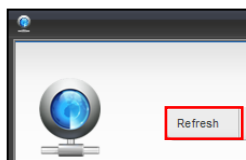

Please note that it is also possible to change the IP addresses manually by using the Web browser. In such case, please plug in only one camera at a time, and change its IP address by using the Web browser before plugging in the next one. This way, the Web browser will not be confused about two devices having the same IP address at the same time.

Access the Camera

Now that the camera and the PC are both having their unique IP addresses and are under the same network segment, it is possible to use the Web browser of the PC to access the camera.

You can use **any of the browsers** to access the camera, however, the full functionality is provided only for **Microsoft Internet Explorer**.

The browser functionality comparison:

Functionality	Internet Explorer	Other browsers
Live Video	Yes	Yes*
Live Video Area Resizable	Yes	No
PTZ Control	Yes	Yes
Capture the snapshot	Yes	Yes
Video overlay based configuration (Motion Detection regions, Privacy Mask regions)	Yes	No
All the other configurations	Yes	Yes

* When using non-Internet Explorer browsers, free third-party software plug-ins must be installed to the PC first to be able to get the live video feed from the camera:

Browser	Required Plug-In
Safari	QuickTime (http://www.apple.com/quicktime/download/)
Other non-Internet Explorer browsers	Basic VLC Media Player (http://www.videolan.org)

Disclaimer Notice: The camera manufacturer does not guarantee the compatibility of its cameras with QuickTime or VLC Player – since these are third party softwares. The third parties have the right to modify their utility any time which might affect the compatibility. In such cases, please use Internet Explorer browser instead.

When using Internet Explorer browser, the ActiveX control for video stream management will be downloaded from the camera directly – the user just has to accept the use of such control when prompted so. No other third party utilities are required to be installed in such case.

The following examples in this manual are based on Internet Explorer browser in order to cover all functions of the camera.

Assuming that the camera's IP address is **192.168.0.100**, you can access it by opening the Web browser and typing the following address into Web browser's address bar:

http://192.168.0.100

Upon successful connection to the camera, the user interface called **Web Configurator** would appear together with the login page. The HTTP port number was not added behind the IP address since the default HTTP port of the camera is 80, which can be omitted from the address for convenience.

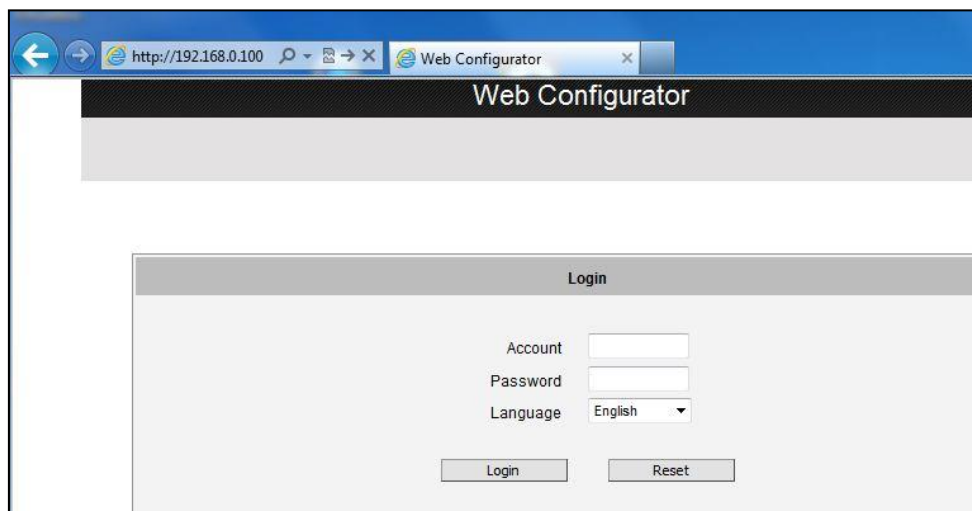

Before logging in, you need to know the factory default Account and Password of the camera.

Account: **Admin**

Password: **123456**

For further operations, please refer to the **Firmware User Manual**.

Appendix

How to Make an Ethernet Cable

1. Prepare the following tools:
 - Ethernet cable without connectors
 - RJ-45 Connector (x2)
 - RJ45 Crimping Tool
 - Scissors
2. Cut about 1 inch into the plastic sheath from the end of the cable.

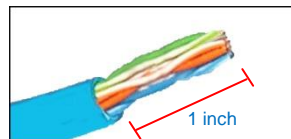

3. Unwind the wires and arrange them according to the color sequence below.

- 1) Stripe Orange
- 2) Orange
- 3) Stripe Green
- 4) Blue
- 5) Stripe Blue
- 6) Green
- 7) Stripe Brown
- 8) Brown

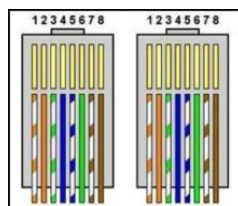

4. Pinch the wires between your fingers and straighten them out.
5. Use the scissors to make a straight cut across the wires ½ inch from the cut end.
6. With the RJ-45 connector tab facing down, push the wires into the connector all the way to the end.

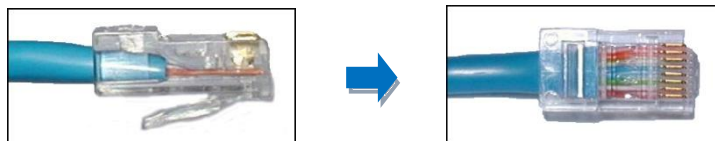

7. Place the connector into the crimping tool, and cinch down to secure the RJ-45 connector to the Ethernet cable.



8. Repeat the same procedures to attach the other end.



Copyright © 2014, ACTi Corporation All Rights Reserved

7F, No. 1, Alley 20, Lane 407, Sec. 2, Ti-Ding Blvd., Neihu District, Taipei, Taiwan 114, R.O.C.

TEL : +886-2-2656-2588 FAX : +886-2-2656-2599

Email: sales@acti.com