

Intercom and Music System Operation & User's Guide

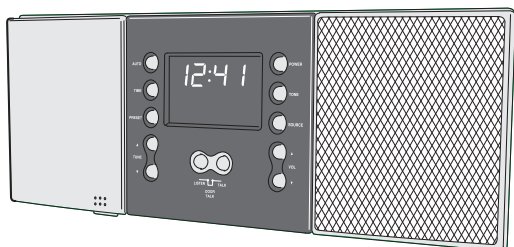

DMC3-4
System Master

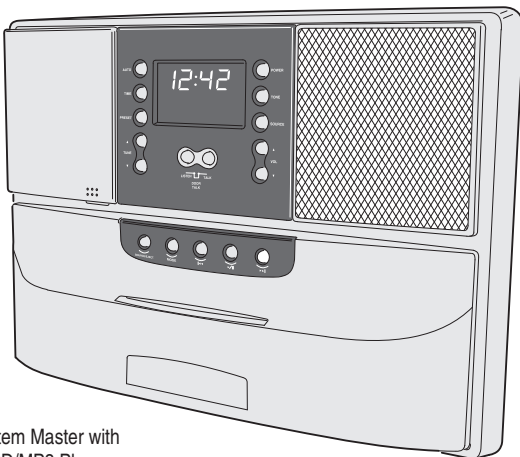

DMC3-4 System Master with
DMCMP3 - CD/MP3 Player

Linear[®]

USA & Canada (800) 421-1587 & (800) 392-0123
(760) 438-7000 - Toll Free FAX (800) 468-1340
www.linearcorp.com

Safety Warnings

CAUTION

**RISK OF ELECTRIC SHOCK
DO NOT OPEN**

CAUTION: TO REDUCE THE RISK OF ELECTRIC SHOCK, DO NOT REMOVE COVER (OR BACK). NO USER-SERVICEABLE PARTS INSIDE, REFER SERVICING TO QUALIFIED SERVICE PERSONNEL.



CAUTION!

The exclamation point within an equilateral triangle is intended to alert the user to the presence of important operating and maintenance (servicing) instructions in the literature accompanying the product.



SHOCK WARNING!

The lightning flash with arrowhead symbol within an equilateral triangle is intended to alert the user to the presence of un-insulated "dangerous voltage" within the product's enclosure that may be of sufficient magnitude to constitute a risk of electric shock to persons.



READ ALL INSTRUCTIONS CAREFULLY BEFORE INSTALLING OR USING THE DMC3-4 SYSTEM.



THE DMC3-4 MUST BE INSTALLED BY TRAINED DEALERS OR INSTALLERS, AND MUST CONFORM TO ALL LOCAL BUILDING AND ELECTRICAL CODES.



Warning: Always follow these safety instructions.



Retain these instructions for future system reference.



DO NOT expose the DMC3-4 to moisture. Doing so can create fire or shock hazards and impair the warranty.



DO NOT expose Patio Stations to direct water spray or damage to the station may occur.



DO NOT attempt to service this product yourself as opening or removing covers may expose you to dangerous voltage or other hazards and will invalidate your warranty. Neither the Master Station nor the Room/Patio Stations contain any user-serviceable parts. REFER ALL SERVICING TO QUALIFIED SERVICE PERSONNEL.



USE ONLY M&S Systems replacement parts and have them installed by an M&S Systems dealer or installer. Unauthorized substitutions can result in fire, electric shock, or other hazards and will void the warranty.



Upon completion of any service or product repair, have the M&S Systems dealer or installer conduct a safety check to ensure the system is in proper operating condition.



Use only a dry cloth to clean the Master Station, Room/Patio Stations, Door Stations, and speakers. Do not use liquid cleaners or aerosol cleaners.

Table of Contents

| | | | |
|--|----|--|----|
| Introduction | 2 | Playing Music | 15 |
| System Overview | 3 | MASTER STATION CONTROLS | 15 |
| THE DMC3-4 SYSTEM | 3 | Music Source | 15 |
| Master Station | 3 | Radio Tuning | 15 |
| Room and Patio Stations | 4 | Setting Radio Presets | 15 |
| Door Stations | 4 | Tuning Radio Presets | 15 |
| System Setup | 5 | ROOM & PATIO STATION CONTROLS | 16 |
| SYSTEM SETTINGS | 5 | Music Source On / Off | 16 |
| Display Brightness | 5 | Adjusting System Music Volume | 16 |
| Clock Settings | 5 | Station Volume | 16 |
| Scan Mode | 6 | Selecting the Music Source | 16 |
| Music Auto On/Off | 6 | CD/MP3 Player | 17 |
| AUDIO SETTINGS | 7 | CD Player Source Selection | 17 |
| Music Volume | 7 | Playing from an MP3 Player | 18 |
| Treble | 7 | Playing a CD | 19 |
| Bass | 7 | CD Playing Controls | 19 |
| Master Station Volume | 7 | Ejecting a CD | 19 |
| Loudness | 7 | Index | 20 |
| Intercom Volume | 7 | Limited Warranty | 22 |
| Station Mode Switches | 8 | 2- Year Limited Warranty | 22 |
| STATION MODES | 8 | | |
| Operating the Intercom | 10 | | |
| INTERCOM FUNCTIONS | 10 | | |
| Intercom Talk | 10 | | |
| Intercom Listen | 10 | | |
| Intercom Monitor | 11 | | |
| Monitor Override | 11 | | |
| DOOR STATION OPERATION | 12 | | |
| Door Talk / Listen | 12 | | |
| Door Release / Security Option | 12 | | |
| ROOM & PATIO STATION OPERATION (4-WIRE) | 13 | | |
| Station Volume | 13 | | |
| Intercom Listen | 13 | | |
| Intercom Talk | 13 | | |
| Door Talk / Listen | 13 | | |
| Door Release / Security Option | 13 | | |
| ROOM & PATIO STATION OPERATION (3-WIRE) | 14 | | |
| Station Volume | 14 | | |
| Intercom Talk | 14 | | |
| Door Talk / Listen | 14 | | |
| Door Release / Security Option | 14 | | |

Introduction

The DMC3-4 is an intercom and sound system designed for today's home. Its compact size and modern, elegant look complement any décor. But it offers more than just sensible good looks. It gives you peace of mind as it allows you to communicate with family members and monitor specified rooms. Plus you can listen to music from AM or FM radio and other sources throughout your home with high-quality sound. With the optional CD/MP3 Player, the system can play from popular phone/music devices and other portable media players.

Please read all of the instructions and safety warnings before changing any settings on your DMC3-4.

Keep this manual in a safe place for future reference. If you lose the manual, you can download it from the Linear Web site: www.linearcorp.com

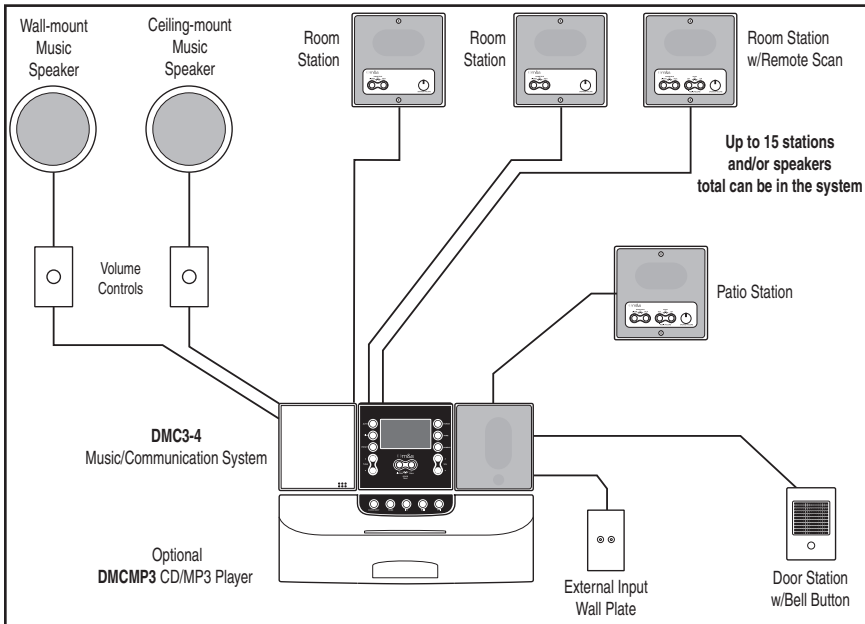
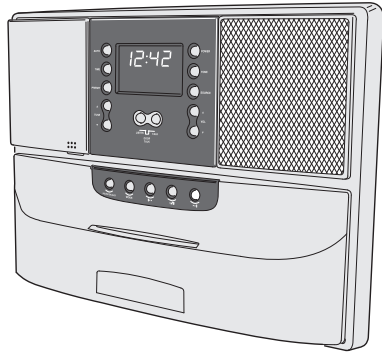

Figure 1. System Overview

System Overview

THE DMC3-4 SYSTEM

The DMC3-4 System consists of three major components:

- **The Master Station** — The Master Station contains the central control electronics, radio receiver, and optional CD/device player for the system and is usually installed in the kitchen or a central location.
- **Room Stations & Patio Station** — Up to nine Room Stations in individual zones, or 15 Room Stations in shared zones on a 4-wire (M&S Systems retrofit) installation and 13 Room Stations in shared zones on a 3-wire (NuTone retrofit), including 2 Patio Stations.
- **Door Stations** — Up to three Door Stations can be installed at entry doors.

Master Station

The Master Station gives you control over the system intercom and music capabilities.

The Master Station has switches that determine how the Master Station and each intercom station functions in the system. Each room can be set to Intercom Only, Radio and Intercom, Off, or Monitor.

The DMC3-4 provides the ability to monitor other stations and communicate with Door Stations at entry doors.

The system can also provide optional electric door control, home security, or home automation features if integrated by your installer.

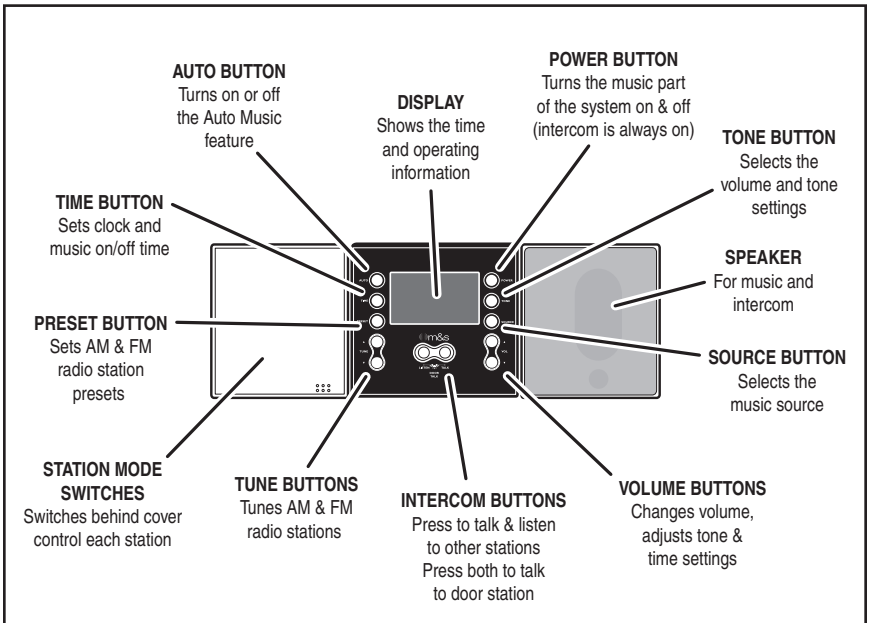

Figure 2. Master Station Features

System Overview

Room and Patio Stations

The Room Stations and Patio Stations provide intercom functions and system music control capabilities.

Depending on the station configuration at the Master Station, a Room Station or Patio Station can communicate with or monitor other stations and communicate with the Door Stations. The system's music can be turned on and off, music volume adjusted, and music sources changed from certain models of room stations.

Door Stations

The Door Station is an exterior intercom speaker and doorbell installed at home entrances. The DMC3-4 system supports up to three door stations. The door station allows for communications from within the house to visitors at the door. Any station with its Intercom Selector Switches set to INTERCOM or RADIO/INT can communicate with the Door Station.

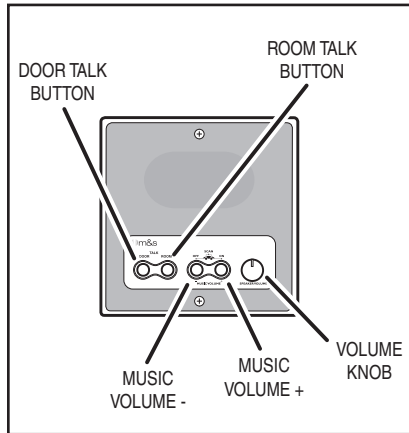

Figure 3. 3-Wire Patio/Room Station Features

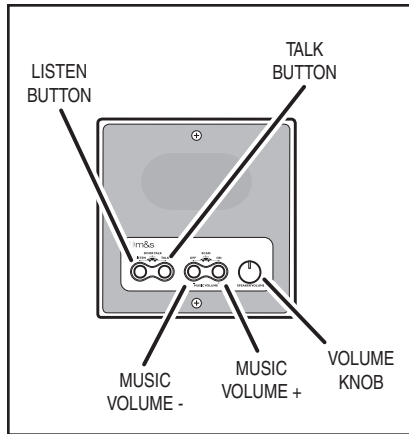

Figure 4. 4-Wire Patio/Room Station Features

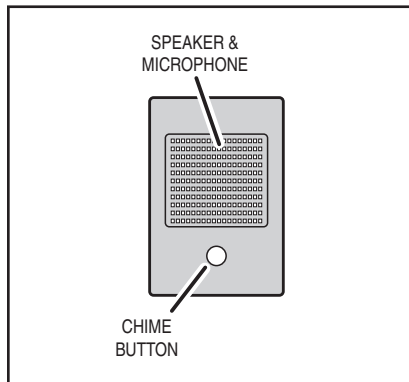

Figure 5. Door Station Features

SYSTEM SETTINGS

Several general system options are setup at the Master Station including:

- Setting the display brightness
- Setting the clock
- Setting the Scan Mode
- Setting the automatic music on and off times
- Setting the volume, loudness, treble, and bass

Display Brightness

The display on the Master Station can be set to three brightness levels to suit the installation location.

Setting the Display Brightness:

1. Simultaneously press the **TUNE ▲** and **POWER** buttons. Each press will cycle the display through the three brightness levels: low, medium, then high.
2. Press the **TUNE ▲** and **POWER** buttons repeatedly until you reach the brightness you prefer.



Figure 6. Master Station Buttons

Clock Settings

You can set two clock functions:

- **Time Display** — Displays the current time of day with AM or PM indication.
 - **Music Auto On/Off** — Sets the times to automatically turn the last music source on and then off.
- ✓ **NOTE:** You can enable or disable the Music Auto On/Off function.

Changing the Clock Settings:

1. Press **TIME**. The hour number blinks and SET TIME appears on the display.
2. Press **VOLUME ▲** or **VOLUME ▼** to set the current hour. An A or P indicates AM or PM.
3. Press **TIME**. The minute number blinks.
4. Press **VOLUME ▲** or **VOLUME ▼** to set the current minute.
5. Press **TIME**. The hour number blinks and AUTO SET ON TIME appears on the display.
6. Press **VOLUME ▲** or **VOLUME ▼** to set the auto on time hour. An A or P indicates AM or PM.
7. Press **TIME**. The minute number blinks.
8. Press **VOLUME ▲** or **VOLUME ▼** to set the auto on time minute.
9. Press **TIME**. The hour number blinks and AUTO SET OFF TIME appears on the display.
10. Press **VOLUME ▲** or **VOLUME ▼** to set the auto off time hour. An A or P indicates AM or PM.
11. Press **TIME**. The minute number blinks.
12. Press **VOLUME ▲** or **VOLUME ▼** to set the auto off time minute.
13. Press **TIME** to return to current time display.

System Settings

Scan Mode

The Scan Mode determines how the system will act when scan is selected from a scan compatible room station or patio station.

Two Scan Modes are available:

- **Scan Mode 1** uses radio station presets. It allows the Room & Patio stations to scan through the four music sources (AUX, AM, FM, and CD). On AM and FM radio bands, **Scan Mode 1 scans through the preset radio stations: AM 1-8 and FM 1-8.**
- **Scan Mode 2** stops at all strong radio stations. Same selection of sources as Scan Mode 1, but on AM and FM radio bands, **Scan Mode 2 scans all strong stations before moving on to the next source.**

Setting the Scan Mode:

1. To change the Scan Mode, simultaneously press and release **PRESET** and **SOURCE** buttons. The display shows either Scan1 or Scan2.
 2. Repeat Step 1 to select one Scan Mode or the other.
- ✓ **Note:** Exit out of setting the scan mode by pressing **PRESET** and **SOURCE** or wait five seconds for the display to show the clock time again.

Music Auto On/Off

You can set the system to turn music on automatically at the preset time and to turn the music off automatically at the preset time.

Automatically Turning Music On and Off:

1. Set the Auto On/Off times as described under Clock Settings.
2. Press the **AUTO** button to toggle between On and Off. When the Auto function is on, **AUTO** appears on the display.

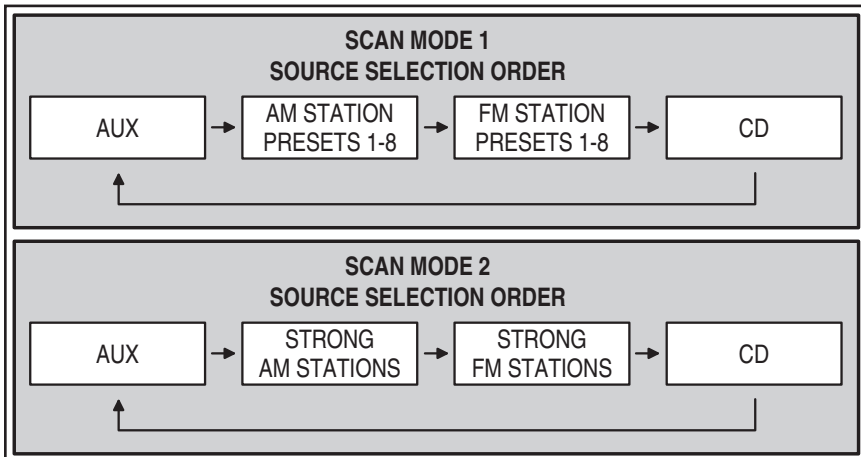

Figure 7. Scan Modes 1 and 2

AUDIO SETTINGS

The system's audio can be adjusted at the Master Station to suit your preferences.

The six system audio adjustment options available. The system will return to normal operation five seconds after the last setting is made.

Music Volume

Adjusts the volume for system music.

Setting the System Music Volume:

1. Press **POWER** to turn on the music.
2. The music volume setting will be the same as it was last set.
3. Use **VOLUME ▲** and **VOLUME ▼** to adjust the music volume from 0-29.

✓ *Note: The music volume setting may vary depending on which source is selected.*

Treble

Adjusts the level of the system's high frequency audio.

Setting the Treble Level:

1. Press **POWER** to turn on the system.
2. Press **TONE** until TREBLE is displayed.
3. Use **VOLUME ▲** and **VOLUME ▼** to adjust the treble level from 0-14.

Bass

Adjusts the level of the system's low frequency audio.

Setting the Bass Level:

1. Press **POWER** to turn on the system.
2. Press **TONE** until BASS is displayed.
3. Use **VOLUME ▲** and **VOLUME ▼** to adjust the bass level from 0-14.

Master Station Volume

Adjusts the volume for intercom communications through the speaker on the Master Station ONLY.

Setting the Master Station Volume:

1. Press **TONE** until MASTER VOLUME is displayed.
2. Use **VOLUME ▲** and **VOLUME ▼** to adjust the Master Station's intercom volume from 0-29.

✓ *Note: When the music is off, use **VOLUME ▲** and **VOLUME ▼** to set the Master Station's intercom volume.*

Loudness

When set to ON, adjusts the bass tone for better listening at low audio levels.

Turning Loudness On and Off:

1. Press **POWER** to turn on the system.
2. Press **TONE** until LOUDNESS is displayed.
3. Press **VOLUME ▲** to turn on the loudness feature. ON will be displayed to the right of the clock.
4. Press **VOLUME ▼** to turn off the loudness feature. OFF will be displayed to the right of the clock.

Intercom Volume

Adjusts the volume for system intercom communications to the Room Stations, Door Stations, and Patio Stations.

Setting the Intercom Volume:

1. Press **TONE** until INTERCOM VOLUME is displayed.
2. Use **VOLUME ▲** and **VOLUME ▼** to adjust the intercom volume from 0-29.

✓ *Note: The intercom volume sets the audio level from the Master Station to the Room Stations, Door Stations, and Patio Stations. The Master Station's volume is set separately.*

Station Mode Switches

STATION MODES

Behind the hinged cover on the left side of the Master Station are 11 slide switches.

These switch settings determine how the Master Station and each intercom station functions in the system. The way the system operates is called the "Station Mode".

These switch settings can be changed at any time to adjust the way the system operates. Over time, as rooms in your residence are used for different members of the family, or for different uses, you can change these switch settings to suit your own requirements.

✓ **Note:** When the system has more than nine Room Stations, some intercom selector switches will control two Room Stations.

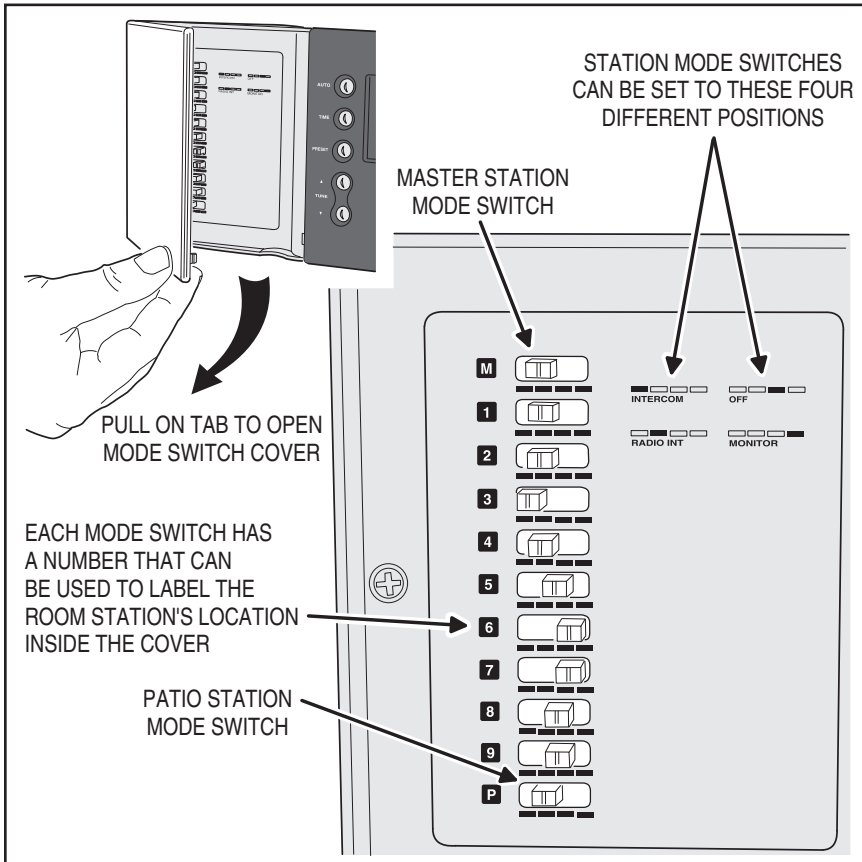

Figure 8. Master Station Switches

Station Mode Switches

Each station can be set to one of the four Station Modes using its mode switch:

Intercom Mode



Station Switch Set to INTERCOM:

- You can talk and listen from this station.
- The station does not receive music.
- The station cannot be continuously monitored.
- The station cannot be used to hear other rooms that are set to **MONITOR**.
- The station hears the door chime and users can talk and listen to the Door Station.

✓ **Note:** When a station is set to **INTERCOM**, the sound and activity in that room can be heard by another Room Station by manually pressing another Room Station's **LISTEN** button.

Radio Intercom Mode



Station Switch Set to RADIO/INT:

- You can talk and listen from this station.
- The station can receive music.
- The station can monitor any other station that is set to **MONITOR**.

✓ **Note:** When music is on, the audio from a monitored room is heard in addition to the music.

- The station cannot be continuously monitored.

✓ **Note:** When a station is set to **RADIO/INT**, the sound and activity in that room can be heard by another Room Station by manually pressing another Room Station's **LISTEN** button.

- The station hears the door chime and users can talk and listen to the Door Station.

Off Mode



Station Switch Set to OFF:

- You can communicate from a Room Station but you cannot communicate from a Patio Station.
- Other Room Stations cannot listen to the station.
- The station cannot receive music or intercom-related audio.
- The station cannot be continuously monitored.
- The station does not hear the door chime and cannot talk and listen to the Door Station.

Monitor Mode



Station Switch Set to MONITOR:

- Any station set to **RADIO/INT** can continuously hear all sound and activity in the this station's room.
- You can communicate with other Room Stations.
- The station cannot hear the door chime.
- You can talk to the Door Station, but will not be able to listen to it.
- The station cannot receive music.
- Other rooms can talk to a monitored station, if the monitor override is set to **ON**.

Operating the Intercom

INTERCOM FUNCTIONS

Operation of the intercom will vary depending on the setting of the Station Mode switches on the Master Station (see Page 8).

The intercom operation methods detailed here describe the how the system will function with Station Mode switches set in various positions.

Intercom Talk

Talk allows users to talk to all stations set to **INTERCOM** or **RADIO/INT** on the Master Station.

Starting an Intercom Session:

1. Press **TALK** and begin speaking to the other stations.
2. You can hear remote users if you press the **LISTEN** button or if they press their **TALK** button.

Intercom Listen

Listen allows users to manually listen to all stations set to **INTERCOM** or **RADIO/INT** on the Master Station.

Listening with the Intercom:

1. Press the **LISTEN** button to listen to the other stations.
2. Press **TALK** if you want to speak to the other stations.

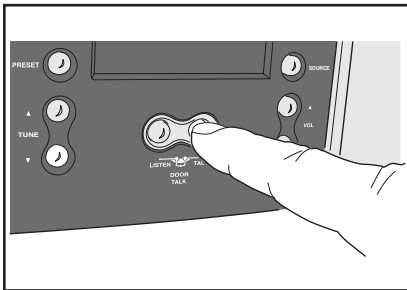

Figure 9. Intercom Talk

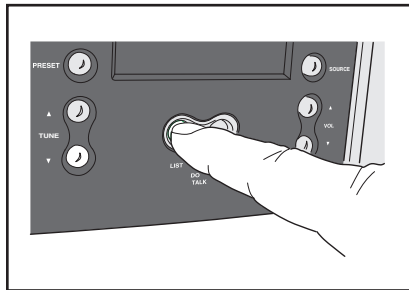

Figure 10. Intercom Listen

Operating the Intercom

Intercom Monitor

Monitoring is useful for listening to baby's rooms, play rooms, and elderly care rooms.

All stations set to **RADIO/INT** on the Master Station can continually hear the sound and activity from a station set to **MONITOR** on the Master Station.

Monitoring Stations:

1. On the Master Station, set the Station Mode switch for the desired station(s) to continually listen for to the **MONITOR** position.
2. All stations set to **RADIO/INT** on the Master Station will play sounds from all station(s) set to **MONITOR** on the Master Station.

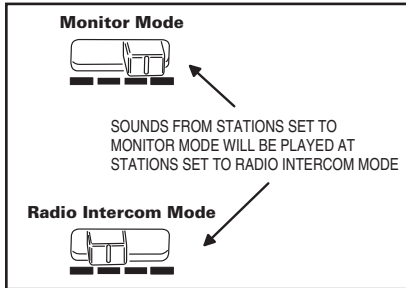

Figure 11. Intercom Monitor

Monitor Override

From the Master Station, you can temporarily override the Monitor function so you can communicate with stations set to **MONITOR**.

Turning Monitor Override On and Off:

1. On the Master Station, press and hold the **AUTO** and **POWER** buttons at the same time.
2. The display will show "MO" and ON or OFF to the right of the clock. When Monitor Override is OFF stations set to **MONITOR** cannot hear any intercom communication or the door chime. When Monitor Override is ON, stations set to **MONITOR** can hear only incoming talk from other room stations.
3. Repeat Step #1 to toggle the Monitor Override to ON or OFF.

✓ **Note:** Exit the monitor override setting by pressing **AUTO** and **POWER** or by waiting five seconds.

Operating the Intercom

DOOR STATION OPERATION

The Door Stations are used to announce visitors with the door chime. The chime can be answered and persons in the residence can have a conversation with the visitor.

When the button on the Door Station is pressed, the chime is heard on all stations set to **INTERCOM** or **RADIO/INT**.

- All system audio (music and intercom) is muted when the chime rings.
- If the Door Station is engaged in a talk or listen session, the chime will be disabled until the session is over.

Door Talk / Listen

On the Master Station (or on a Patio or Room Station), press **TALK** and **LISTEN** together to enter Door Talk Mode. This allows you to talk to the Door Stations. All other stations set to **INTERCOM** or **RADIO/INT** can hear the conversation.

Release the **TALK** and **LISTEN** buttons to listen to the Door Station. The Door Listen Mode is active for a total of 25 seconds after you release the **TALK** and **LISTEN** buttons. You may talk again at any time by pressing the **TALK** and **LISTEN** buttons. Each time the buttons are released, you can listen for another 25 seconds.

- ✓ **Note:** Door Talk mode is suspended at the end of the 25 second listening period or if you press either the **TALK** or the **LISTEN** button individually.

Door Release / Security Option

This optional feature can control another system connected by your installer. For example, it may control a door release mechanism, turn on the lights, or activate an alarm.



Figure 12. Door Station Operation

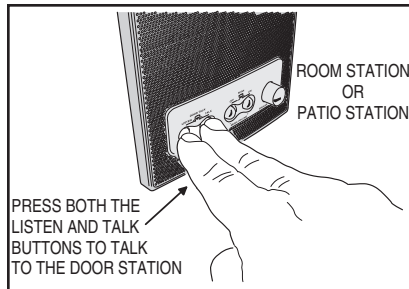

Figure 13. Door Talk / Listen

Activating the Door Release Option:

1. Press and hold the **VOLUME ▲** and **VOLUME ▼** buttons for about five seconds.
2. The display will indicate **RELEASE** when the option is activated. The Door Release output is active for as long as both buttons are held pressed.
3. Release the buttons to stop the Door Release output.

- ✓ **Note:** This function is available from the Master Station and all remote scan Room Stations. For security reasons, it is not available from a Patio Station.

Operating the Intercom

ROOM & PATIO STATION OPERATION (4-WIRE)

The 4-wire (M&S Systems retrofits) Room Stations and Patio Stations support the talk and listen intercom functions of the system and also feature several buttons and knobs that control the system.

Station Volume

You can set the volume for each station independently.

- Adjust the **SPEAKER VOLUME** knob to set the station's volume.

Intercom Listen

You can listen to all stations set to **INTERCOM** or **RADIO/INT.**

- Press the **LISTEN** button on the station to listen to the other stations.

Intercom Talk

You can talk to all stations set to **INTERCOM** or **RADIO/INT.**

- Press the **TALK** button on the station to talk to the other stations.

Door Talk / Listen

When the door chime sounds, you can talk and listen to Door Stations.

- Press **TALK** and **LISTEN** together to enter Door Talk Mode and talk to the visitor.
- Release **TALK** and **LISTEN** to listen to the visitor. Door Listen Mode lasts 25 seconds each time the buttons are released.

Door Release / Security Option

You can activate the door release or security option from Room Stations (not allowed from Patio Stations).

- Press and hold the **VOLUME +** and **VOLUME -** buttons on the station for about five seconds to activate the Door Release Output.

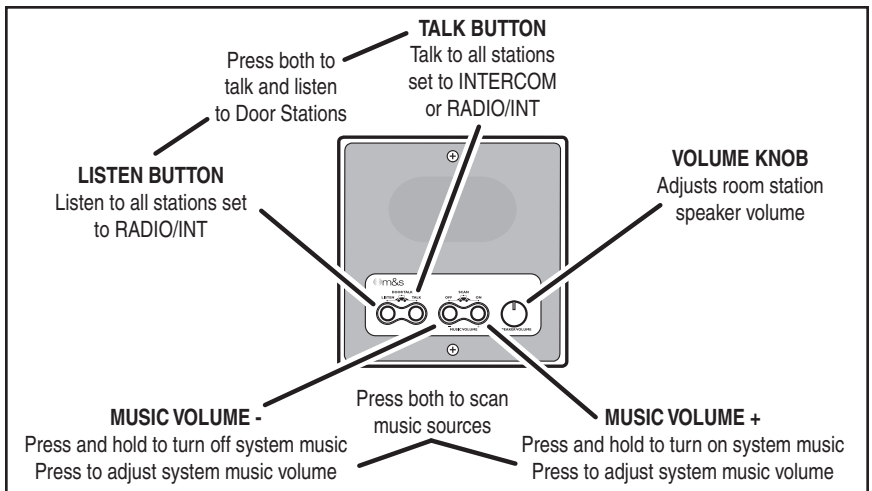

Figure 14. 4-Wire Room Station and Patio Station Intercom Controls

Operating the Intercom

ROOM & PATIO STATION OPERATION (3-WIRE)

The 3-wire (NuTone retrofits) Room Stations and Patio Stations support the talk and listen intercom functions of the system and also feature several buttons and knobs that control the system.

Station Volume

You can set the volume for each station independently.

- Adjust the **SPEAKER VOLUME** knob to set the station's volume.

Intercom Talk

You can talk to all stations set to **INTERCOM** or **RADIO/INT.**

- Press the **ROOM TALK** button on the station to talk to the other stations.

Door Talk / Listen

When the door chime sounds, you can talk and listen to Door Stations.

- Press **DOOR TALK** to enter Door Talk Mode and talk to the visitor.
- Release **DOOR TALK** to listen to the visitor. Door Listen Mode lasts 25 seconds each time the buttons are released.

Door Release / Security Option

You can activate the door release or security option from Room Stations (not allowed from Patio Stations).

- Press and hold the **VOLUME +** and **VOLUME -** buttons on the station for about five seconds to activate the Door Release Output.

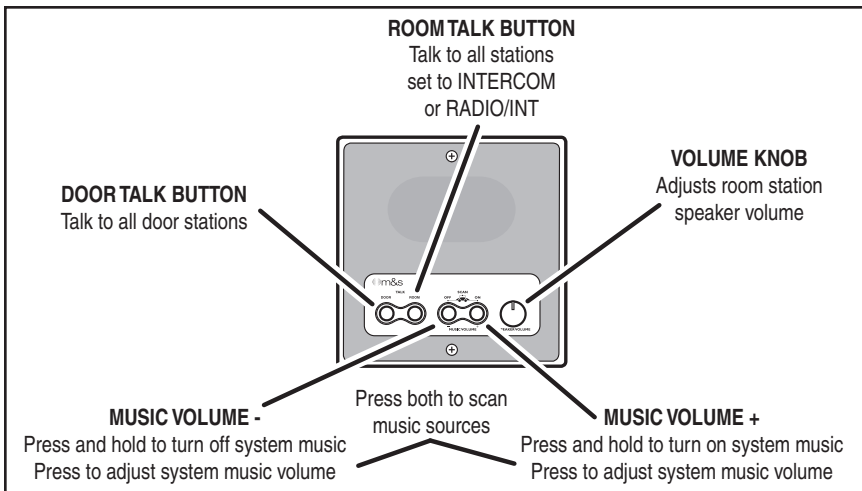

Figure 15. 4-Wire Room Station and Patio Station Intercom Controls

MASTER STATION CONTROLS

The Master Station has controls for operating the music functions of the intercom system.

Music Source

You can select from four music sources:

- AM — The AM radio band (530 to 1710 KHz).
- FM — The FM radio band (87.5 to 107.9 MHz).
- CD — The optional built-in CD/MP3 Player.
- AUX — Any source you connect to the optional Audio Input Wall Plate, such as an external CD player, portable music player, or a stereo system.

Selecting a Music Source:

1. Press **POWER** to turn on music.
2. Press **SOURCE** repeatedly to cycle through AM, FM, CD and AUX until you reach the music source you prefer.

✓ **Note:** The music volume setting may vary depending on which source is selected.

Radio Tuning

FM or AM radio stations can be tuned to manually or tuned with stored station presets.

Tuning to a Radio Station:

1. Press **POWER** to turn on the music.
2. Press **SOURCE** to select FM or AM.
3. Use **TUNE ▲** or **TUNE ▼** to find a station. If you press and release **TUNE ▲** or **TUNE ▼**, within 1 second, the tuner goes into Seek Mode and finds the next station with a strong signal. If you press and hold **TUNE ▲** or **TUNE ▼**, the tuner goes into Scan Mode and scans all frequencies until you release the button.

✓ **Note:** For the first two seconds, the tuner scans at slow speed to allow for fine tuning. After two seconds, the tuner scans at fast speed.

Setting Radio Presets

Up to eight presets can be stored for the FM band. Up to eight presets can also be stored for the AM band.

Setting Radio Station Presets:

1. Press **POWER** to turn on the music.
2. Press **SOURCE** to select FM or AM.
3. Use **TUNE ▲** or **TUNE ▼** to find a station. See above for seek and scan functions.
4. Press and hold the **TUNE ▲** and **TUNE ▼** buttons to enter Store Preset Mode. The display shows PRESET and a preset number. Continue to hold the **TUNE ▲** and **TUNE ▼** buttons for 5 seconds. The display updates to show the new station for the preset number.
5. If you want to select the preset number, use the **TUNE ▲** and **TUNE ▼** button to find a station. Press and hold the **TUNE ▲** and **TUNE ▼** buttons to enter the Store Preset Mode. Press the **PRESET** button repeatedly to cycle through numbers 1-8 until you reach the preset number you want. Wait 5 seconds. The display updates to show the new station for the preset number.

✓ **Note:** This activity can be cancelled at any time during the process by pressing **TUNE UP** and **TUNE DOWN** simultaneously again, and no new preset is stored.

Tuning Radio Presets

Preset radio stations can be selected at the Master Station.

Tuning to a Preset Radio Station:

1. Press **POWER** to turn on music.
2. Press **SOURCE** to select FM or AM.
3. Press **PRESET** to select one of the preset stations. The station preset number is indicated on the Master Station's display.

Playing Music

ROOM & PATIO STATION CONTROLS

The Room Stations and Patio Stations support the music functions of the intercom system.

Music Source On / Off

You can turn the Music Source on and off from any Room Station or Patio Station.

Turning Music Source On or Off:

- To turn the Music Source on, press the **MUSIC VOLUME +** button.
- To turn the Music Source off, press the **MUSIC VOLUME -** button until the volume level goes to zero.

Adjusting System Music Volume

You can adjust the system wide music volume from any Room Station or Patio Station.

Adjusting System Music Volume:

- Adjust the system music volume from any Room/Patio Station by pressing **VOLUME +** or **VOLUME -**.

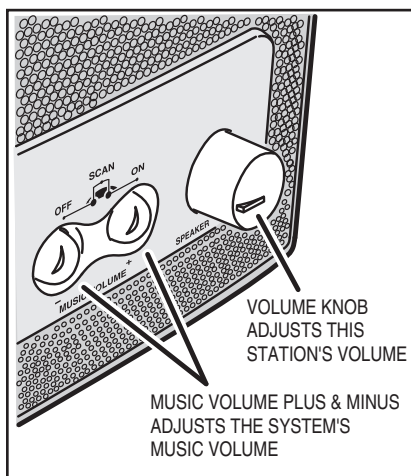

Figure 16. Room Station and Patio Station Music Controls

Station Volume

You can set the volume for each station independently.

Adjusting a Station's Volume:

- Adjust the **SPEAKER VOLUME** knob to set the station's volume.

Selecting the Music Source

The system music source can be selected from any Room Station or Patio Station. The music sources that are available vary depending on which Scan Mode is set in the Master Station (see Page 6).

✓ **Note:** The music volume setting may vary depending on which source is selected.

In the Master Station has two Scan Modes:

- **Scan Mode 1** — Allows the Room/Patio stations to scan through the four music sources (AM, FM, CD, and AUX). **On radio bands AM and FM, Scan Mode 1 scans through the preset radio stations: AM 1-8 and FM 1-8.**
- **Scan Mode 2** — Same selection of sources. **On radio bands AM and FM, Scan Mode 2 scans all strong stations before moving on to the next source.**

To Select a Music Source:

- Press and release the **VOLUME +** and **VOLUME -** buttons at the same time to switch music sources.

✓ **Note:** You cannot select specific tracks on a CD or remotely control a portable device or an MP3 player from a Room Station or Patio Station.

CD/MP3 Player

One of the options for the system is the CD/MP3 Player that can be installed below the Master Station.

The multi-source player can provide music from four types of devices:

- Generic portable MP3 players connected to the 3.5 mm audio input jack on the side of the device drawer. The drawer also provides a USB connector for charging the portable MP3 player.
- Standard music CD discs. Also CD-ROMs in standard CDA audio format burned by computer CD writers on CD-R or CD-RW recordable media.
- MP3 music CD discs. CD-ROMs of MP3 audio files burned by computer CD writers on CD-R or CD-RW recordable media.

CD Player Source Selection

The system can play music from four sources (AM, FM, CD, and AUX). Select the CD source to play music from the CD/MP3 disc player or the audio input jack on the player.

Selecting the CD Player as Source:

1. Press **POWER** to turn on the system.
2. On the master Station, press **SOURCE** repeatedly to cycle through AM, FM, CD and AUX until you reach **CD**.

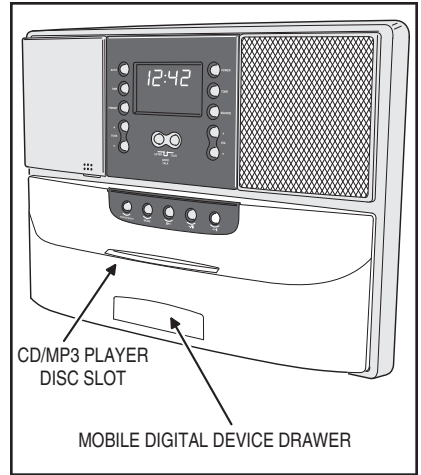

Figure 17. DMCMP3 CD & MP3 Player

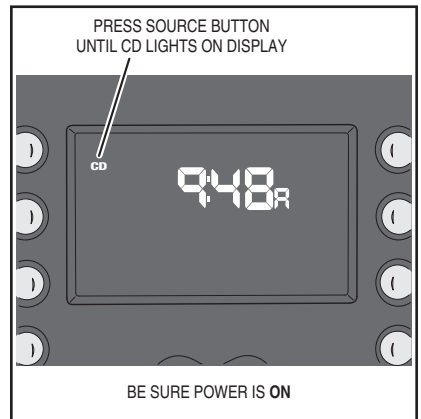

Figure 18. CD/MP3 Player Source Selected

Playing Music

Playing from an MP3 Player

Portable MP3 players sit on top of the device drawer's rubber inner cover.

Audio from the player's headphone jack connects to the 3.5 mm audio input jack on the side of the device drawer with the cable supplied.

The player can be charged (whether its currently being used for music or not) using the USB charging jack on the side of the device drawer (cable is not supplied).

✓ **Note:** Depending on their design, some devices may not accept a battery charge when connected to the USB charging jack on the device drawer.

Playing a Portable MP3 Player:

1. Press **POWER** to turn on the system.
2. On the master Station, press **SOURCE** repeatedly to cycle through AM, FM, CD and AUX until you reach **CD**.
3. Press on the front of the device drawer to unlatch the spring lock and extend the drawer all the way out.
4. Connect the headphone jack on your MP3 Player to one end of the 3.5 mm audio cable.
5. Connect the other end of the audio cable into the audio input jack on the side of the device drawer.
6. Set your MP3 Player on top of the rubber cover.
7. To charge the MP3 Player (optional) connect a charging cable between the MP3 Player and the USB jack on the side of the device drawer.
8. If a CD is inserted in the player, press the **SOURCE/EJECT** button on the CD Player to choose between the CD and the MP3 Player.
9. Select your music on the MP3 Player and begin playing. THE BUTTONS ON THE MASTER STATION DO NOT CONTROL THE PLAYER, USE THE BUTTONS ON THE PLAYER.
10. The MP3 player's volume control will affect the overall volume of the system, set it about mid-level, then use the master and station volume controls.

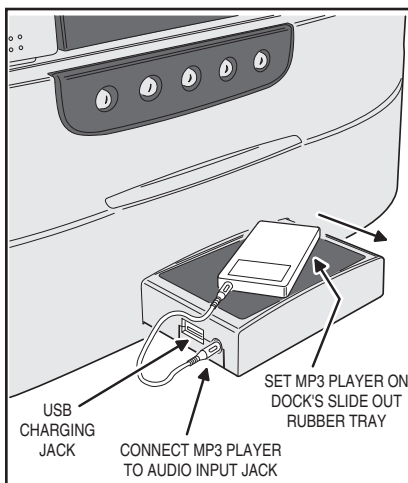

Figure 19. MP3 Player on Device Drawer

✓ **Note:** To prevent damage, be sure to close the device drawer when a player is not connected.

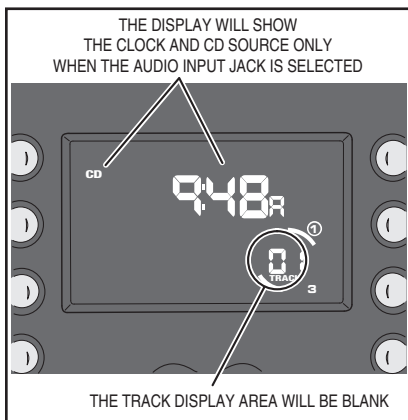

Figure 20. Display Showing Audio Input Jack Selection

Playing a CD

One standard CD disc or a CD-ROM containing MP3 audio files can be played at a time. The **MODE** button selects the way the CD Player will play the CD:

- Normal play will play all the tracks on the CD in order until the disc is finished.
- Repeat Song continuously plays the current track on the CD.
- Repeat Disc continuously plays the entire disc in normal track order.
- Random Disc plays the entire disc once in random order.
- Random All continuously plays the entire disc in random track order.

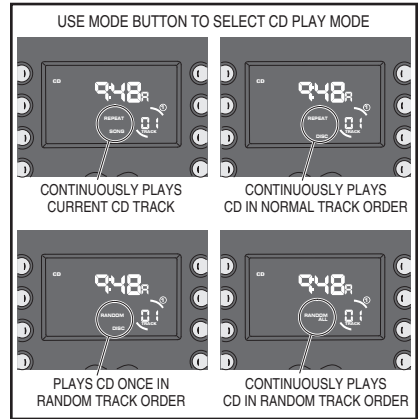

Figure 21. CD Mode Displays

CD Playing Controls

Five buttons are provided to control the player when a CD is inserted.

Playing a CD:

1. Press **POWER** to turn on the system.
2. On the master Station, press **SOURCE** repeatedly to cycle through AM, FM, CD and AUX until you reach **CD**.
3. Insert a CD into the player's slot.
4. Use the **MODE** button to choose a playing mode. See Figure 21 for the display's mode indication.
5. Play the CD using the player's controls (see Figure 23). The display shows the current player status (see Figure 22.)

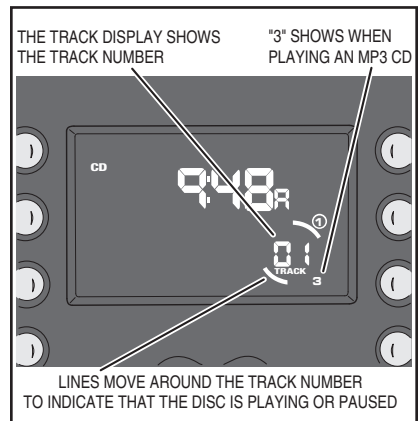

Figure 22. CD Status Display

Ejecting a CD

To eject a CD disc, press and hold the **SOURCE/EJECT** button.

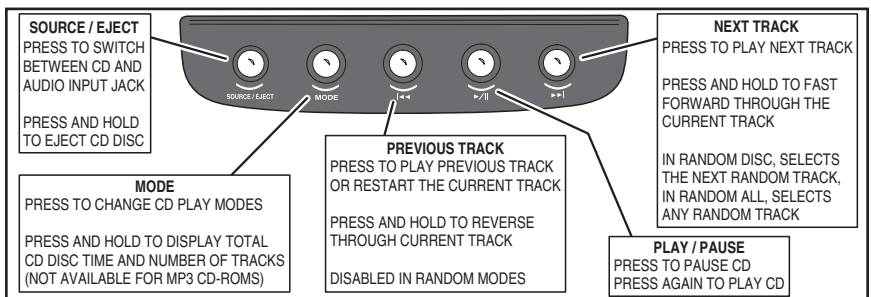

Figure 23. CD Player Controls

Index

- A**
 - Adjusting system music volume 16
 - Adjusting the station's volume 16
 - AM radio source 15
 - Audio settings 7
 - Auto button 3
 - Automatically turning music on and off 6
 - Auxiliary source 15
- B**
 - Bass adjustment 7
- C**
 - CD/MP3 Player 17
 - CD player source selection 17
 - CD playing controls 19
 - CD source 15
 - Clock settings 5
- D**
 - Display brightness 5
 - Door chime 12
 - Door release 12, 13, 14
 - Door Station 3, 4
 - Door Station features 4
 - Door Station operation 12
 - Door talk and listen 12, 13, 14
- E**
 - Ejecting a CD 19
- F**
 - FM radio source 15
- I**
 - Intercom buttons 3
 - Intercom functions 10
 - Intercom listen 10, 13, 14
 - Intercom mode 9
 - Intercom monitor 11
 - Intercom talk 10, 13, 14
 - Intercom volume 7
- L**
 - Listen button 13, 14
 - Listening with the intercom 10
 - Loudness adjustment 7
- M**
 - Master Station 3
 - Master Station controls 15
 - Master Station display 3
 - Master Station speaker 3
 - Master Station switches 8
 - Master Station volume 7
 - Mode button 19
 - Monitoring stations 11
 - Monitor mode 9
 - Monitor override 11
 - Monitor override on and off 11
 - Music auto on/off 5, 6
 - Music source 15, 16
 - Music source on and off 16
 - Music volume 7
 - Music volume - 13, 14
 - Music volume + 13, 14
- N**
 - Next track button 19
 - Normal play 19
- O**
 - Off mode 9
 - Operating the intercom 10, 11, 12, 13, 14
- P**
 - Patio Station 3, 4
 - Patio Station controls 16
 - Patio Station features 4
 - Patio Station operation 13, 14
 - Patio Station volume knob 16
 - Playing a CD 19
 - Playing an MP3 CD-ROM 19
 - Playing from an MP3 player 18
 - Playing music 15, 16, 17, 18, 19
 - Play / pause button 19
 - Power button 3
 - Preset button 3
 - Preset radio stations 15
 - Previous track button 19
- R**
 - Radio/intercom mode 9
 - Radio presets 15
 - Radio tuning 15
 - Random all 19
 - Random disc 19
 - Repeat disc 19
 - Repeat song 19
 - Room Station 3, 4
 - Room Station controls 16
 - Room Station features 4
 - Room Station operation 13, 14
 - Room Station volume knob 16

S

- Safety warnings ii
- Scan mode #1 6, 16
- Scan mode #2 6, 16
- Scan modes 6
- Selecting a music source 15
- Selecting CD player source 17
- Selecting the music source 16
- Setting radio presets 15
- Setting system music volume 7
- Setting the bass level 7
- Setting the intercom volume 7
- Setting the Master Station volume 7
- Setting the scan mode 6
- Setting the treble level 7
- Source button 3
- Source/eject button 19
- Speaker button 3
- Speaker volume knob 13, 14
- Starting an intercom session 10
- Station modes 8
- Station mode switches 3, 8, 9
- Station volume 13, 14, 16
- Supported CD-ROM formats 17
- System overview 3, 4
- System overview diagram 2
- System settings 5
- System setup 5

T

- Talk button 13, 14
- Time button 3
- Time display 5
- Tone button 3
- Treble adjustment 7
- Tune buttons 3
- Tune radio up or down 15
- Tuning radio presets 15
- Tuning to a radio station 15
- Turning loudness on and off 7
- Turning music source on or off 16

U

- USB charging jack 18

V

- Volume knob 13, 14, 16

Limited Warranty

2-Year Limited Warranty

Linear LLC warrants these products to be free of defects for 2 years. The warranty period begins on either (a) the date of purchase or installation date of this product or (b) the date of closing on a new residence in which this product was originally installed. The warranty extends to the original user of the product and to each subsequent owner of the product during the term of the warranty. Linear LLC will repair or replace, at its option, parts and materials at no charge. Parts supplied under this warranty may be new or rebuilt at the option of Linear LLC.

If during the warranty period the product appears to have a defect, please call our toll free service number (800-421-1587) prior to dismantling. Dismantling the product prior to calling our service number may void the warranty. Before returning any product to Linear LLC, obtain a Return Product Authorization Number (RPA) from our service department. Linear LLC will return the repaired product freight prepaid within the continental United States. ANY PRODUCT RETURNED TO LINEAR LLC WITHOUT A RPA NUMBER WILL BE REFUSED.

This limited warranty is in lieu of any other warranties, express or implied, including any implied warranty of merchantability or fitness for a particular purpose or otherwise, and of any other obligations or liability on the seller's part. This limited warranty does not cover damage caused by improper installation, acts of God, criminal acts, the violation of applicable building or electrical codes or the use of non-recommended wire, cable (excluding CAT-5 and RG-6) or wall housings.

Under no circumstances shall Linear LLC be liable for consequential, incidental or special damages arising in connection with use, or inability to use this product. In no event shall Linear LLC liability hereunder exceed the cost of the product covered hereby. No person is authorized to assume for us or obligate us for any other liability in connection with the sale of this product. Some states do not allow the exclusion or limitation of consequential, incidental or special damages, so the above limitation or exclusion may not apply to you. This limited warranty gives you specific legal rights, and you may also have other rights, which vary from state to state.

Linear[®]

USA & Canada (800) 421-1587 & (800) 392-0123
(760) 438-7000 - Toll Free FAX (800) 468-1340
www.linearcorp.com