

Congratulations on purchasing an e3 eMerge access control system. This e3 eMerge Quick Start Guide provides simple instructions on how to get the system up and running. For more detailed information, please refer to the e3 Installation Manual (620-100531).

## 1

### Mounting the e3 eMerge

Run all necessary wires to the panel location.

1. Remove the enclosure's cover by removing the door of the housing. Unlock the door and disconnect the ground wire. The door may be lifted out of the hinge slots.
2. Remove the metal cabinet knock-outs required for wire entry.
3. Level the enclosure on a sturdy wall. Mark the mounting holes with a pencil. (The cabinet can be vertically or horizontally mounted depending on space requirements.)
4. Partially insert screws into the top two mounting holes and hang the enclosure on the screws.
5. Pull all wires through the knock-out holes in the enclosure. Label each wire according to its use.
6. Recheck for level, insert the two lower screws, and tighten all four mounting screws.
7. Install bushings as needed in cabinet knockouts to protect wires from damage.
8. Re-install the door and connect the ground wire to the door.

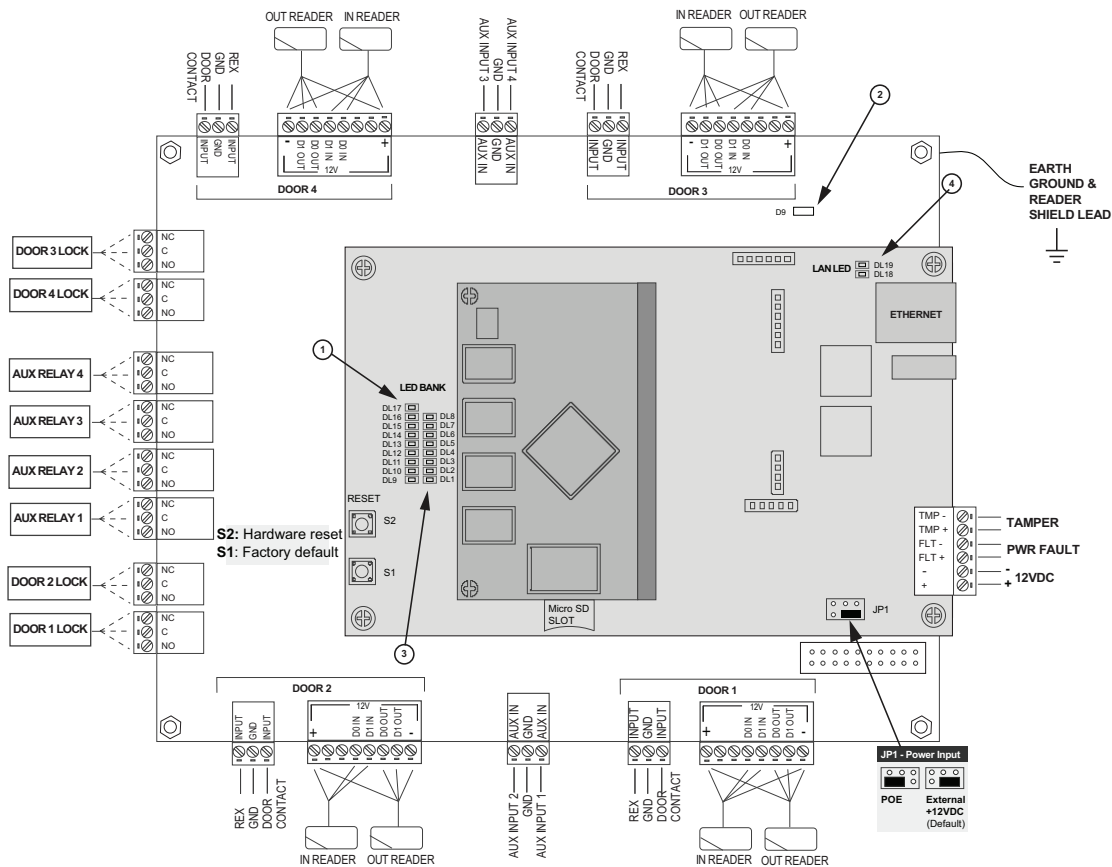

## 2

### e3 eMerge Power Connection

1. Connect the 12VDC from the included power supply to the RED (+) and BLACK (-) leads on the panel.
- Note: e3 eMerge systems require a 12VDC, 2 amp Class 2 power supply. Incorrect voltage will damage the product and void the warranty.*
2. Connect an earth ground to the green earth ground lead provided in the enclosure.
  3. Turn on the power supply. If using a plug in power supply (PIP) for the power supply, it must be plugged into a dedicated receptacle that is not controlled by a switch.
  4. The power LEDs (DL17 and DL9) on the panel will turn on to indicate power is present.
  5. OPTIONAL: Connect the leads to the battery (see below).

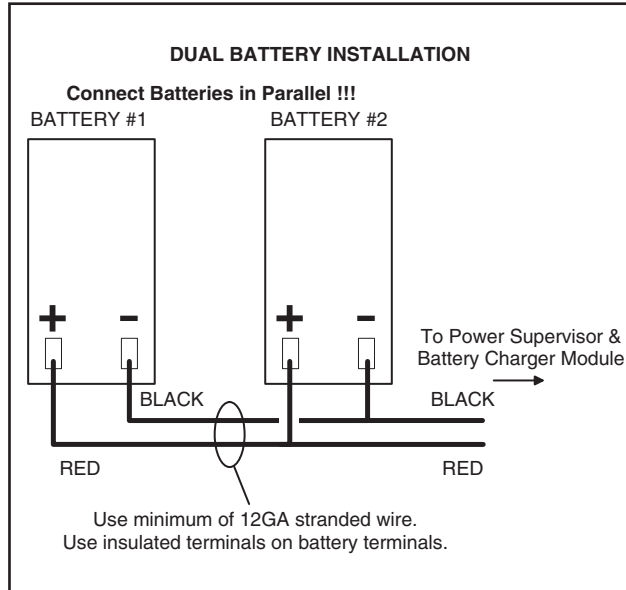
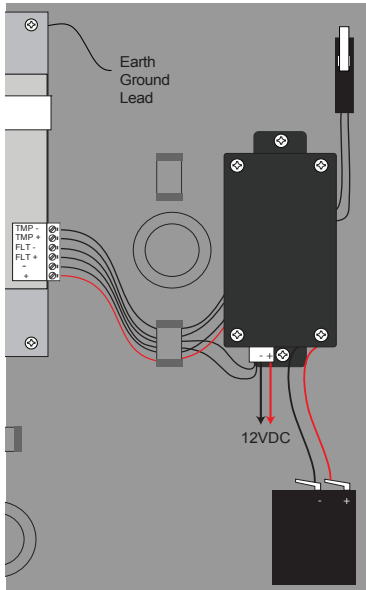

## 3

### Preparing for the Network

To allow for the e3 eMerge to be recognized on the local network, it is necessary to change the controller's IP address.

1. Connect your programming computer directly to the Ethernet port of the controller.
2. Assign a static IP address of 192.168.0.149 to the computer. (For instructions on how to change the static IP address of a Windows computer, please visit: <http://technet.microsoft.com/en-us/library/ff710457>).
3. After assigning the static IP address, open a web browser and enter the IP address of the controller (Default = 192.168.0.250).
4. The controller presents the Linear login page. To log on, enter the default user ID and password (admin/admin).
5. Browse to the Network Configuration (IP address) page as shown. Enter the static IP address, Subnet Mask, Gateway and DNS server (provided by the network administrator) so that it matches the requirements of the local network.

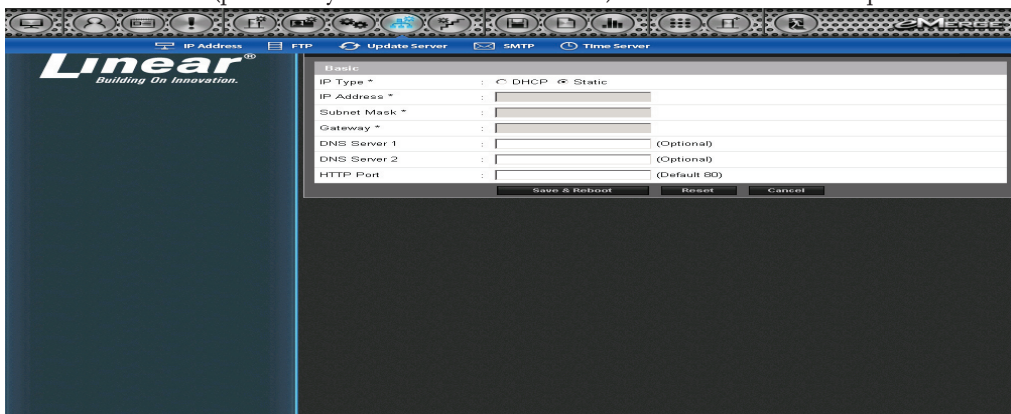

6. Click **Save & Reboot** and the system will reboot. (Reboot will take approximately 2 minutes.) **Note:** The system data will be lost if the controller is powered down without performing **Save & Reboot**.
7. Disconnect the programming computer from the control panel. The *system* is now ready for the local network.

## 4 Connecting to the Network

1. Pull an Ethernet cable through the opening in the enclosure nearest the Ethernet port.
2. Plug the RJ-45 connector into the Ethernet port on the controller.
3. Connect to the local area network (LAN)
4. If the network connection is functioning properly, the LAN LEDs on the control panel will illuminate. The local computers will then be able to access the system by entering the IP address of the controller.

## 5 Identifying the Server and Client

Some eMerge systems provide the ability to add additional controllers to expand the amount of doors, inputs and outputs. These additional controllers are referred to as clients. A client can be mounted on top of the main controller (server) or in a separate enclosure.

IP Installer is a utility located on a **thumb drive** shipped with all systems. This utility provides a simple method of identifying the IP address of the controller(s).

1. Connect all controllers to the local network.
2. Connect the thumb drive (included with the e3) to a Windows computer on the local network.
3. Locate IPInstaller.exe and double-click the file.
4. IP Installer will open. Click **Scan** to search the network for controllers.
5. When controllers are identified they will be listed in IP Installer.

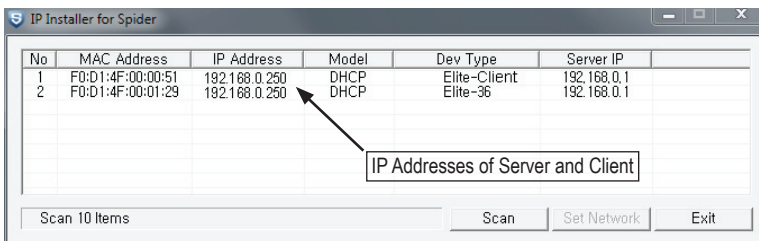

## 6 Configuring the Server and Client

The default IP address of the server and client is 192.168.0.250. To avoid conflict on the network, the IP address of the client and server must be changed as follows:

1. Connect the server to the network.
2. Open IPInstaller.exe and click **Scan**.
3. Select the server from the list and click **Set Network**.
4. Enter a new IP address for the server. This information must be provided by the IT Administrator.
5. Change the Subnet Mask and Gateway to meet the requirements of the local network. This information must be provided by the IT Administrator.
6. Enter the IP Installer password (default = 4321) and click **OK**.
7. Connect the client to the network and repeat steps 1 through 4 to change the client's IP address.

## Assigning the Server to Client

After the controllers are located on the network, the client must be linked to the server as follows:

1. Using a web browser on a local computer, enter the IP address of the client as configured in IP Installer.
2. The browser presents the log in page as shown.

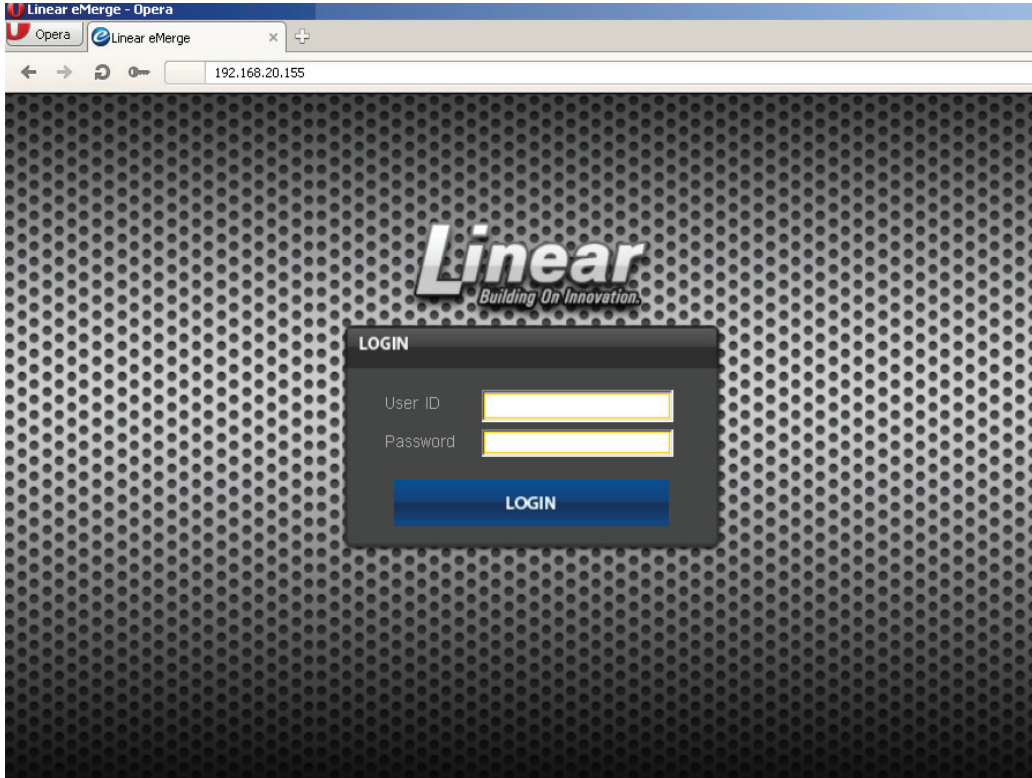

3. To log on, enter the user name (default = admin) and password (default = admin).
4. After a successful log on, the browser presents the page as shown. Click **Edit**.

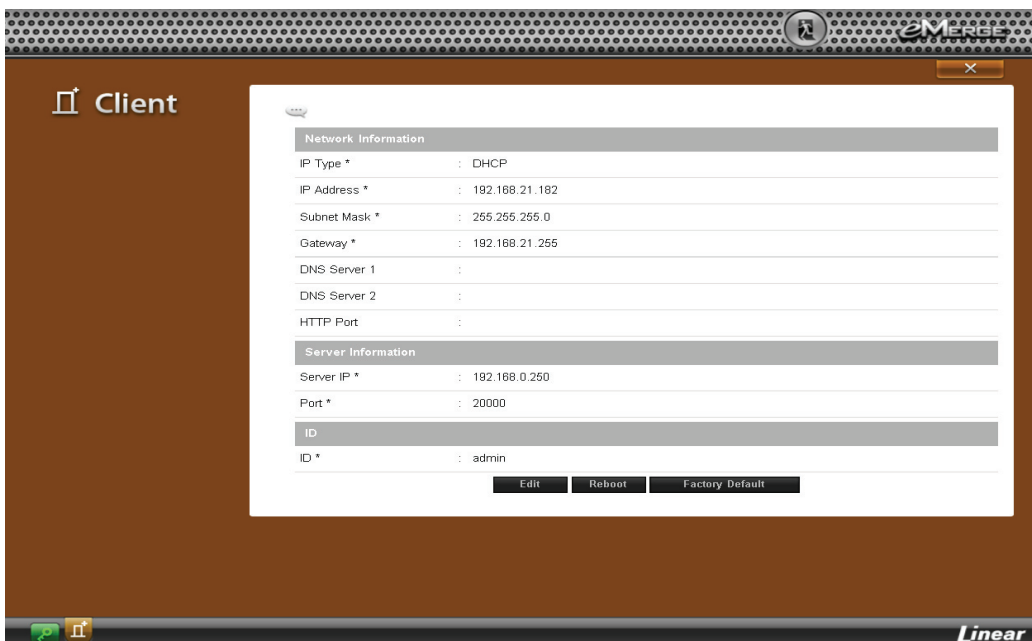

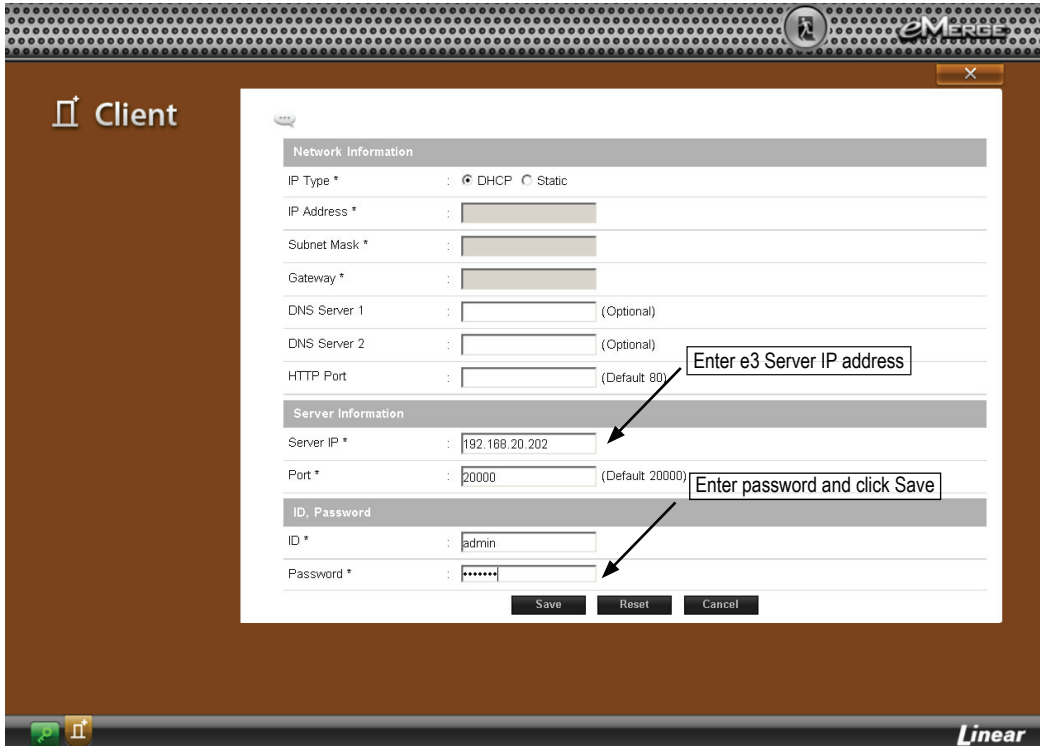

5. Enter the IP address of the server as entered in IP Installer.
6. Enter the password (default = admin) and click Save.

## 8

### Linking Client to Server

1. Using a web browser on a local computer, enter the IP address of the server as configured in IP Installer.
2. The browser presents the Linear login page. Enter the user name and password (default = admin/admin).

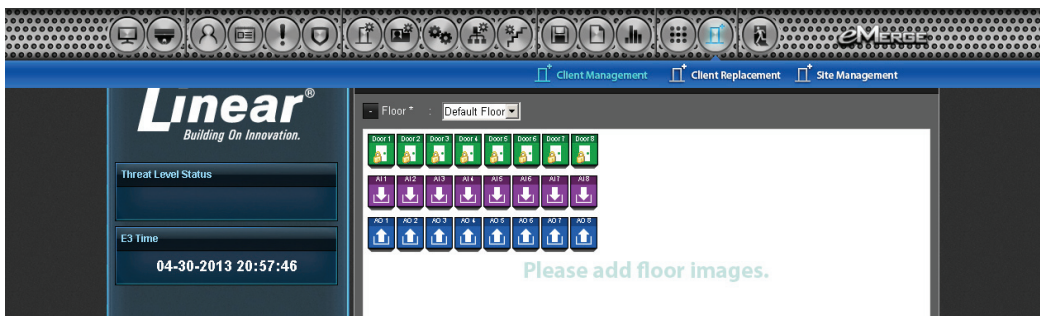

3. After logging in, click *Client Management*.

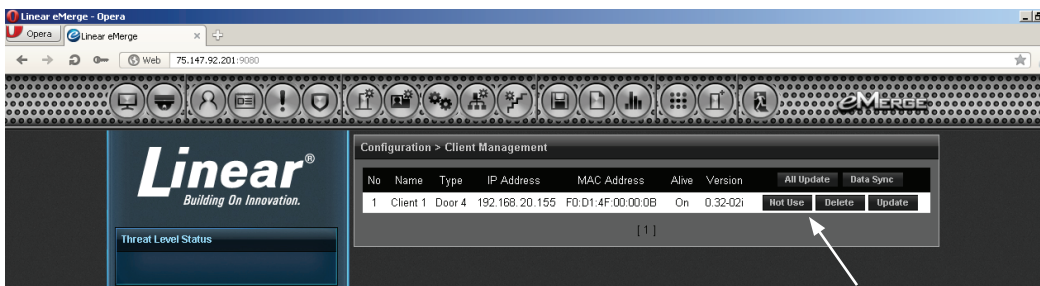

4. The client will appear in the list. Click the *Use* button to link the client to the server. The button will display *Not Use* when the client is successfully linked to the server.

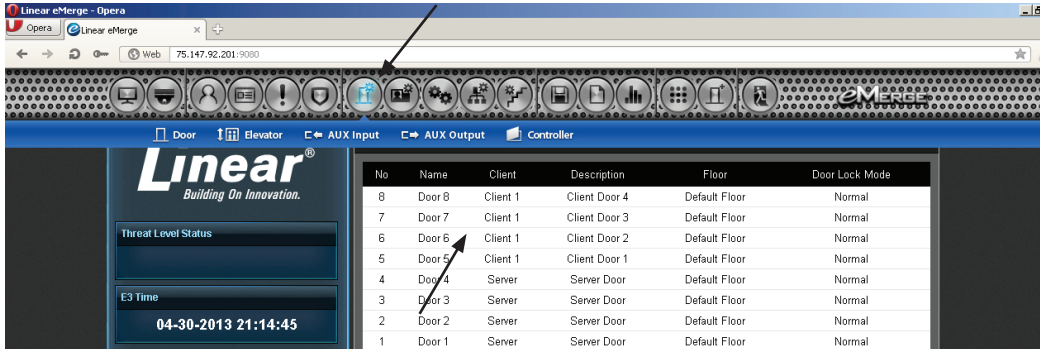

5. Click the *Door* icon and verify that the client doors are listed. The client and server are now linked together.

## 9

### Programming the System

The *e3 eMerge* system provides the ability to access and manage the system from a web browser on any local or remote computer. The system can be programmed using a simple Wizard tool, which allows the user to configure the basic settings of the system. Visit the Wizard at any time by clicking the icon  in the lower left corner of the *e3 eMerge* web page. Refer to the *User Programming Guide* (P/N 620-100240) for specific programming and configuration instructions.





 **NORTEK**  
SECURITY & CONTROL  
USA & Canada (800) 421-1587 & (800) 392-0123  
(760) 438-7000 - Toll Free FAX (800) 468-1340  
[www.nortekcontrol.com](http://www.nortekcontrol.com)