



# EVERFOCUS

1/3" Sony CCD Aluminum Box Housing  
Color Camera  
Operation Instructions

Model No. **EQ350/EQ250**

Please read this manual first for correct installation and operation. This manual should be retained for future reference. The information in this manual was current when published. The manufacturer reserves the right to revise and improve its products. All specifications are therefore subject to change without notice.

## **PRECAUTIONS**

**1. Do not install the camera near electric or magnetic fields.**

Install the camera away from TV, radio transmitter, magnet, electric motor, transformer, audio speakers since the magnetic fields generate from above devices will distort the video images.

**2. Never disassemble the camera nor put impurities in it.**

Disassembly or impurities may result in trouble or fire.

**3. Never face the camera toward the sun.**

Direct sunlight or severe ray may cause fatal damage to sensor and internal circuit.

**4. Keep the power cord away from water and liquid.**

Touching the wet power cord may result in electric shock.

**5. Never install the camera in areas exposed to water, oil or gas.**

Water, oil or gas may result in failure, electric shock or fire.

## **6. Cleaning**

Do not touch the surface of sensor by hand directly. Use a soft cloth to remove the dirt from the camera body. Use lens tissue or a cotton swab and ethanol to clean the sensor and the camera lens.

## **7. Do not operate the camera beyond the specified temperature, humidity or power source ratings.**

Use the camera at temperatures within 0°C~50°C (32°F~122°F) and humidity between 20%~ 80%. The input power source are 12VDC/24VAC; 100~240VAC.

## **PREFACE**

This new series is a solid-state color video camera specially designed for high quality surveillance applications. It incorporates break through DSP technology that provides most reliable and accurate color picture in security industry. The camera is convenient to use with C-mount or CS-mount lenses and easy back-focus adjustment help to achieve installation efficiency.

## **FEATURES**

- Industry leading super high-res. with 560 TVL (EQ350 model)
- Revolutionary integrated 10-bit Digital Signal Processor (DSP) delivers sharp color images and excellent picture quality
- Wide range automatic electronic shutter: 1/60 (1/50) ~ 1/100,000
- Auto line lock with external phase adjustment
- C/mount or CS-mount adjustable with easy back-focus adjustment wheel on the camera
- Smart FL mode for fluorescent light or 1/100 sec (NTSC)
- Utilizing innovative Pure Vision Technology

## **STANDARD ACCESSORIES**

- Camera Unit x 1
- Accessory Pack includes
  - Mounting Base for bracket
  - M2 Screws x 4 for fixing mounting base
  - Lens Connector
- Manual x 1

## SPECIFICATIONS

Type	EQ350	EQ250
Pickup Device	1/3" SONY Super HAD CCD	
Picture Elements	NTSC: 768(H) x 494(V) PAL: 752(H) x 582(V)	NTSC: 510(H) x 492(V) PAL: 500(H) x 582(V)
Video Format	NTSC or PAL	
Scanning System	NTSC: 525 TV lines, 60 fields/sec PAL: 625 TV lines, 50 fields/sec	
Horizontal Resolution	560TVL	380TVL
Sensitivity	0.5Lux/F=1.2	0.3Lux/F=1.2
S/N Ratio	Over 48dB(AGC off)	
Electronic Shutter	1/50(1/60)~1/100,000	
Lens Type	C/CS mount Video Drive / Direct Drive	
Back Light Comp.	ON/OFF Switch	
Auto Gain Control	ON/OFF Switch	
Fluorescent Light	ON/OFF Switch	
Auto White Balance	Yes	
Gamma Correction	0.45	
Video Output	BNC 1.0Vp-p , 75ohm	
Sync. Mode	Line Lock/Internal Sync	
Phase Control	V-Phase +/- 90°	
Power Source	2 types: 100VAC~240VAC 12VDC/24VAC	
Power Consumption	100VAC~240VAC: 12VA max. 24VAC: 7VA max. 12VDC: 4.5W max.	
Dimensions	57mm(W) x 51mm(H) x 140.2mm(D); 2.25"(W) x 2"(H) x 5.52"(D)	
Weight	0.5kg ; 1.1lbs	
Operating Temperature	0°C~50°C ; 32°F~122°F (20%~80% Humidity)	
Certifications	FCC/CE	

## DIMENSIONS

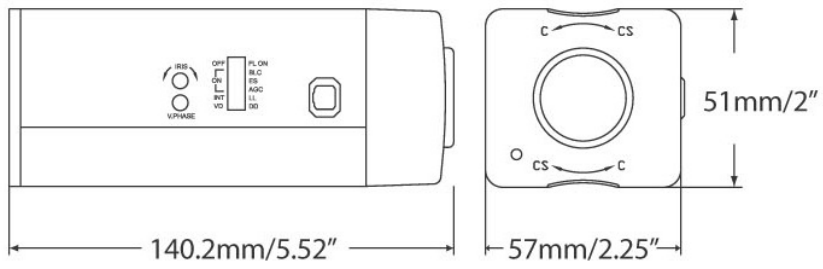

(Unit:mm/inch)

# MAJOR PARTS NAME & THEIR FUNCTIONS

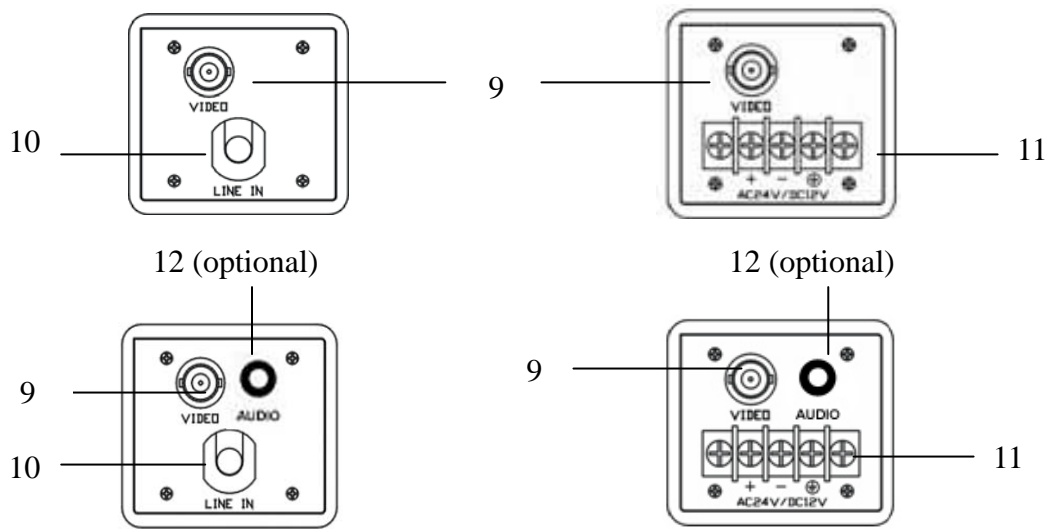
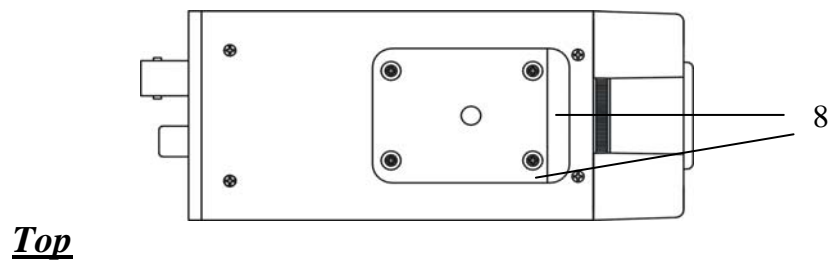
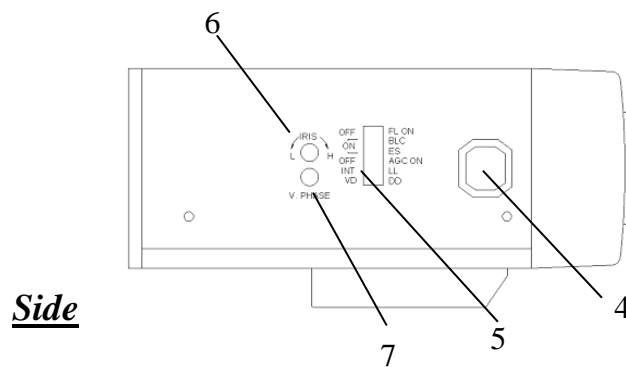
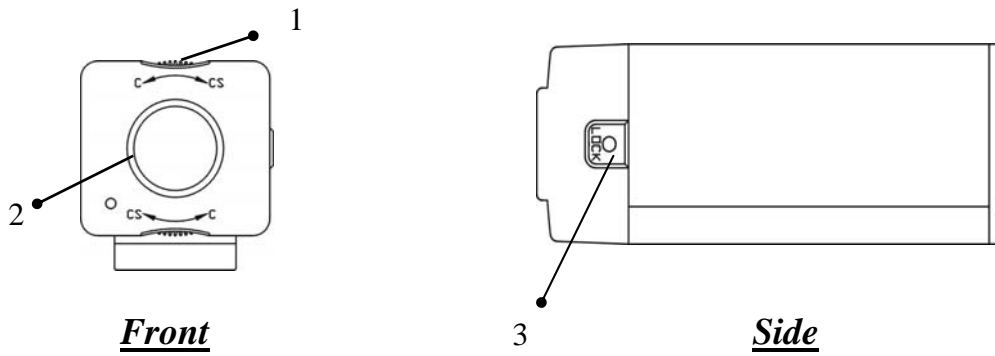

## Rear (EO series)

## Rear (EO series" A")

### **1. Focal Length Adjustment Ring**

Use this ring to adjust the appropriate focal length according to the type of lens. Rotate the ring clockwise for the CS-mount lens, rotate it counterclockwise for the C-mount lens. The factory setting is CS-mount.

### **2. Lens Mount**

To mount an appropriate C-mount or CS-mount lens.

### **3. Locking Screw**

Use the locking screw to fix the focal length.

### **4. Lens Connector (4 pin socket)**

To connect to the lens plug of the auto iris lens.

### **5. Control Switches**

There are 6 control switches located on the sideboard, which are for the setting of the special features. The switches in orders are for Flickerless, Back Light Compensation, Electronic Shutter, Automatic Gain Control, Line-Lock and Auto Iris Lens type.

#### **Fluorescent ON/OFF**

This is a compensation function for against the images flicker fiercely during fluorescent light condition. Shooting the images in fluorescent light by using turn on the Fluorescent function, the default setting is Off.

#### **BLC (Back Light Compensation) ON/OFF**

When BLC is turned on, the AGC, ES and IRIS operating point is determined by averaging over the center area instead of entire field-of-view, so that a dimly-lit foreground object at center area can be clearly distinguished from brightly-lit backgrounds.

BLC should not be used unless it is needed to compensate for back-lit. The default

setting is OFF.

### **ES (Electronic Shutter) OFF/ON**

ES ON: The camera continuously adjusts the shutter speed from 1/60 (NTSC), 1/50 (PAL) second to 1/100,000 second according to the luminance conditions of the scene.

ES OFF: The shutter speed is fixed at 1/60 (NTSC), 1/50 (PAL) second.

Set ES OFF, when auto iris lens is used or flicker is observed under a very bright fluorescent lamp. Otherwise, turn ES on for optimum performance. The default setting is ON.

### **AGC (Automatic Gain Control) OFF/ON**

AGC ON: The sensitivity increases automatically when light is low.

AGC OFF: A-low-noise picture is obtained under a low light condition.

The default setting is ON.

### **LL (Line-Lock) OFF/ON**

To select the sync mode between Internal Sync.(LL off) and Line-Lock (LL on).

Set the line-lock off, the camera will synchronize to the internal time base. Set the line-lock on, the camera's vertical synchronization can be driven by the AC signal in the power lines.

Note: The cameras feature AC line lock for external synchronization, using the AC power frequency (60Hz) is possible but not available in using DC or other operation power such as NTSC in 50Hz or PAL in 60Hz power system.

### **VD/DD (Auto Iris lens Type)**

For video drive auto iris lens, please set switch to VD. For direct drive iris lens, set switch to DD. The default setting is DD. Wire the cable of lens to lens connector according to the following table.

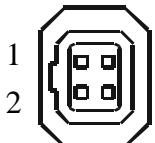
	<u>Pin1</u>	<u>Pin2</u>	<u>Pin3</u>	<u>Pin4</u>	Lens Connector
Video Drive	+12V	GND	VD-IRIS	GND	
			6		

Direct Drive    Cnt-    Cnt+    Drv+    Drv-

## **6. IRIS Level Control**

Brightness Level can be adjusted from the IRIS level VR while using the direct drive lens.

Turn counterclockwise to L to get darker picture.

Turn clockwise to H to get brighter picture.

## **7. V-Phase Adjustment Screw**

The vertical phase may require adjustment to synchronize the vertical phase of the camera with other camera in the system when it is to be used in the line-lock sync mode. Make the adjustment when the vertical phase of the camera does not match with other cameras.

## **8. Mounting Base and Fixing Screws**

To use when the mounting bracket is required while mounting the camera. The mounting base can be attached to either the top or the bottom of the camera, fix the mounting base onto the camera by using the 4 supplied fixing screws.

## **9. Video Output Connector**

BNC VBS 1.0 V<sub>p-p</sub>, 75ohm

## **10. Power Cable (EQ series)**

## **11. 12VDC/24VAC Screw Terminals (EQ series "A")**

## **12. Audio Output (optional)**

Connect with an audio device, RCA connector



## **INSTALLATION**

1. Remove the cover cap from the top of the lens mount.
2. To attach a C-mount/CS-mount lens, turn the focal length adjustment ring to the appropriate position.

*Note: If a C-mount lens is used, please make sure the focal length adjustment ring is set at C position before fixing the lens.*

3. Screw the lens firmly onto the lens mount. Insert the lens plug in the lens connector if the auto iris lens is used.
4. Tighten the locking screw.
5. Connect the video output of the camera to a color monitor or other video device through a 75 ohm type coaxial cable with BNC female connector.
6. Plug the power cord to the outlet.
7. Once the image appears on the monitor, adjust the focus and diaphragm of the lens to obtain the best picture.
8. If the subject is not in focus when adjusting focus of lens, do focal length adjustment as following:
  - i. Loosen the locking screw of the focal length adjustment ring.
  - ii. Take picture of subject at a distance more than 20m away from the camera.
  - iii. Rotate the focal length adjustment ring to bring the subject in focus.
  - iv. Tighten the locking screw while the adjustment is completed.

# ***EverFocus Electronics Corp.***

## **Head Office:**

12F, No.79 Sec. 1 Shin-Tai Wu Road,  
Hsi-Chih, Taipei, Taiwan  
TEL: +886-2-26982334  
FAX: +886-2-26982380  
www.everfocus.com.tw

## **USA L.A. Office:**

1801 Highland Ave. Unit A  
Duarte, CA 91010, U.S.A.  
TEL: +1-626-844-8888  
FAX: +1-626-844-8838  
www.everfocus.com

## **USA N.Y. Office:**

415 Oser Avenue Unit S  
Hauppauge, NY 11788  
TEL: 631-436-5070  
FAX: 631-436-5027  
www.everfocus.com

## **Europe Office:**

Albert-Einstein-Strasse 1  
D-46446 Emmerich, Germany  
TEL: 49-2822-9394-0  
www.everfocus.de

## **China Office:**

Room B-05D-1, KESHI PLAZA , Shangdi  
Information Industry Base,  
Haidian District, Beijing China  
100085  
TEL: +86-10-62973336/37/38/39  
FAX: +86-10-62971423  
www.everfocus.com.cn

## **Japan Office:**

1809 WBG MARIBU East 18F,  
2-6 Nakase.Mihama-ku.  
Chiba city 261-7118, Japan  
TEL: +81-43-212-8188  
FAX: +81-43-297-0081  
www.everfocus.com

	<p>Your EverFocus product is designed and manufactured with high quality materials and components which can be recycled and reused. This symbol means that electrical and electronic equipment, at their end-of-life, should be disposed of separately from your household waste. Please, dispose of this equipment at your local community waste collection/recycling centre. In the European Union there are separate collection systems for used electrical and electronic product. Please, help us to conserve the environment we live in!</p>	<p>Ihr EverFocus Produkt wurde entwickelt und hergestellt mit qualitativ hochwertigen Materialien und Komponenten, die recycelt und wieder verwendet werden können. Dieses Symbol bedeutet, dass elektrische und elektronische Geräte am Ende ihrer Nutzungsdauer vom Hausmüll getrennt entsorgt werden sollen. Bitte entsorgen Sie dieses Gerät bei Ihrer örtlichen kommunalen Sammelstelle oder im Recycling Centre. Helfen Sie uns bitte, die Umwelt zu erhalten, in der wir leben!</p>
---	--	--



P/N: MQ35G02100\_Ver.B