

CAMSWITCH™ PLUS

COMPACT 802.3AT POE 10/100 SWITCH



Compact and versatile POE switch for reliable IP camera installations

CAMSWITCH Plus delivers the power and practicality you need to effectively support Power over Ethernet equipment.

802.3af POE / 802.3at POE Plus compliant outputs

57V POE for maximum efficiency and range

POE input allows remote network expansion

4+1 and 8+2 channel models

Rugged enclosure with wall and rack mount options

Up to full 802.3at Power over Ethernet for IP cameras

CAMSWITCH Plus 10/100 Ethernet switches feature full IEEE 802.3af/at POE compliance to support IP cameras and other POE-powered devices, and can be powered using a local power supply or a unique POE input.

Power where you need it

CAMSWITCH 4 Plus is a 5-port 10/100 switch including four POE outputs, and one port for non-POE downlink or optional POE input.

CAMSWITCH 8 Plus is a 10-port 10/100 switch featuring eight POE

outputs, and two further ports, one of which has an optional POE input.

CAMSWITCH Switches are exceptionally compact and rugged, and require no user configuration. Ethernet speed, duplex and crossover are detected or negotiated automatically, and IEEE 802.3af/at POE is delivered

automatically to compliant devices. For other equipment, all ports can be used for regular non-POE Ethernet connections.

Wall-mount clips are included and CAMSWITCH 8 Plus is also compatible with Veracity's configurable rack-mounting system.

Versatile power input for maximum power budget

CAMSWITCH Plus may be used with Veracity's 57V DC power supply models, providing a range of power budgets to suit each installation.

Veracity's class-leading power system delivers the maximum power, efficiency, and reliability available within the POE standard. It also supports maximum range extension: using CAMSWITCH

Plus is equivalent to adding an OUTSOURCE Plus injector or separate 57V power supply when delivering POE to OUTREACH Max, LONGSPAN or HIGHWIRE PowerStar.

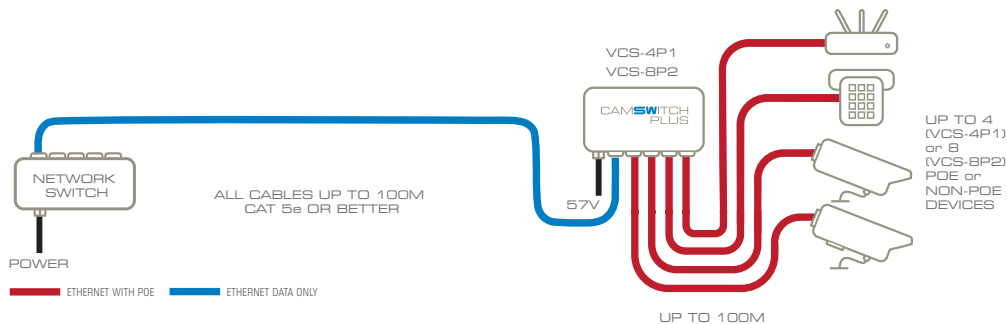

Use POE power for extending range or adding devices

CAMSWITCH Plus can also be powered by POE, supporting remote positioning, range extension, or adding devices to existing cables.

Veracity's OUTSOURCE Plus injector is recommended for maximum POE budget and range, however for applications with low POE requirements



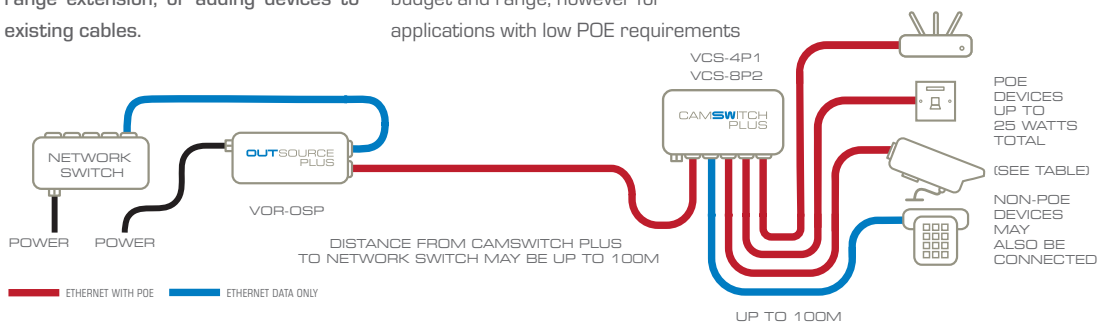

















or data-only connections, a regular 802.3af switch may be used.



Selecting the right power source

CAMSWITCH Plus can be powered by a range of AC adapters or POE sources to suit the budget required:

Power Budget

POWER SOURCE	BUDGET	SUPPORTS (example)
VPSU-57V-800 Power Supply	40 watts	 OR 
VPSU-57V-1500 Power Supply	78 watts	       
Veracity Rack Power System	200 watts	       
802.3af POE Switch	10 watts	
VOR-OSP OUTSOURCE Plus POE Injector	25 watts	 

 Typical static IP camera (up to 8 watts)  PTZ dome using POE Plus (up to 25.5 watts)

How to work out the total power required for a camera installation:

1. Look up the power in watts from each camera's datasheet. Allow for any devices which may be added in future.
2. Add these figures together to find the total budget required. (Cable losses are already accounted for and do not need to be included)
3. Select a power source which can support the budget required or greater.

All ports can always be used for network connections. POE is only enabled to compliant devices; non-POE Ethernet equipment can simply be connected as normal.

POE power classes are not used by CAMSWITCH Plus, as they are often unreliable. However in the absence of other information, they can be used to estimate a camera's power requirement as follows:

- a POE class 1 camera will draw 3.8 watts or less
- a POE class 2 camera will draw 6.5 watts or less
- a POE class 3 or 0 camera (full 802.3af) will draw 13 watts or less
- a POE class 4 camera (full 802.3at) will draw 25.5 watts or less



Wall mounting

Neat snap-on mounting brackets permit secure wall mounting where required.



Rack mounting

CAMSWITCH 8 Plus is designed to fit in Veracity's configurable rack mounting system. A rack mount plate allows up to 4 units to be mounted in only 1U of space.

Veracity's forthcoming rackmount power system delivers up to 200 watts of power to each installed product, with optional redundancy.

TECHNICAL SPECIFICATION

CAMSWITCH™ 4 PLUS/ 8 PLUS

POWER INPUT	
Power source	DC power supply or Power over Ethernet
DC connector	Detachable screw terminal Rear connector for rack-mount or 1500mA power supply (VCS-8P2) Adaptor cable included for 1500mA power supply (VCS-4P1)
DC voltage	44-57V, Class II isolated (Veracity power supply recommended)
POE standard	IEEE 8023.af or Veracity OUTSOURCE Plus (recommended for max. budget)
Device power	3 watts typical (both models)
POE OUTPUTS	
POE standard	IEEE 8023.af / IEEE 802.3at compliant Enhanced POE supports maximum range when used with OUTREACH Max, LONGSPAN or HIGHWIRE PowerStar (equivalent to using OUTSOURCE Plus or 57V power supply) Power budget limited by power source specified; see table on previous page
ETHERNET INTERFACE	
Connector	RJ45, 5-port unmanaged 10/100 switch
Rates	10BASE-T or 100BASE-T and duplex, auto-configuring for speed
Cable	Straight through or crossover Cat 5, Cat 5e or Cat 6 patch VCS-8P2 supports VLAN trunking
LED INDICATORS	
Green - POE Ports	Constant POE enabled Off No POE requested
Green - Non POE Ports	Constant Power OK Off No power
Yellow	Constant Ethernet OK Blink Network activity
PHYSICAL/ENVIRONMENTAL	
Dimensions	L 110mm / 131mm with side clips W 64mm / 76-80mm including connectors H 22mm (VCS-4P1) / 40mm (VCS-8P2)
Mounting (brackets inc.)	5mm mounting holes on 122mm centres
Weight	135g [4.8oz] (VCS-4P1) / 225g [7.9oz] (VCS-8P2)
Operating temperature	-10°C to 50°C [14°F to 122°F]
Relative humidity	Up to 85%, non-condensing
Compliance	CE, FCC, RoHS
PRODUCT CODES	
VCS-4P1	CAMSWITCH 4 Plus 4+1 port 802.3at POE network switch
VCS-8P2	CAMSWITCH 8 Plus 8+2 port 802.3at POE network switch
VPSU-57V-800-UK	Optional UK power supply for CAMSWITCH Plus 40 watt budget
VPSU-57V-800-US	Optional US power supply for CAMSWITCH Plus 40 watt budget
VPSU-57V-800-EU	Optional EU power supply for CAMSWITCH Plus 40 watt budget
VPSU-57V-1500-UK	Optional UK power supply for CAMSWITCH Plus 78 watt budget
VPSU-57V-1500-US	Optional US power supply for CAMSWITCH Plus 78 watt budget
VPSU-57V-1500-EU	Optional EU power supply for CAMSWITCH Plus 78 watt budget
VOR-OSP	OUTSOURCE Plus, enhanced POE injector 25 watt budget

Notes : 1U rack plate and power systems coming soon



Americas & Asia Sales :
Veracity USA Inc.
65 Harristown Road
Glen Rock
NJ 07452
USA

Tel: 1-800-679-1590
Fax: 1-800-679-0714
www.veracityglobal.com
sales@veracityusa.com

EMEA Sales :
Veracity UK Ltd
Prestwick International Aerospace Park
4 Dow Road
Prestwick
KA9 2TU
UK
Tel +44 (0) 1292 264967
Fax +44 (0) 845 528 1081
www.veracityglobal.com
sales@veracityuk.com