



1.0 Description

These instructions cover the installation of the FMM-325A (Single Action) and FMM-325A-D (Dual Action) Analog Addressable Manual Pull Station kits in an analog system controlled by Bosch FPA-1000 Analog Addressable Fire Alarm Control Panels (FACPs). The kits contain an FLM-325-IM Contact Module with either an FMM-100-S or FMM-100-D Manual Pull Station.

Install, test and maintain the pull stations according to these instructions, NFPA 72, Local Codes and the Authority Having Jurisdiction (AHJ). Failure to follow these instructions may result in failure of the device to operate properly. Bosch is not responsible for improperly installed, tested or maintained devices.

 These instructions contain procedures to follow in order to avoid personal injury and damage to equipment.

 NFPA 72 requires a complete system wide functional test be performed following any modifications, repair, upgrades, or adjustments made to the system's components, hardware, wiring, programming, and software/firmware.

The FMM-100-S and FMM-100-D Manual Pull Stations are UL Listed manual alarm-initiating devices. They communicate with the FACP polling circuit through an FLM-325-IM Analog Addressable Point Contact Module. The die cast housing flush mounts to a single gang switch box, having a minimum depth of 2-1/8 in. (5.4 cm) or surface mounts using an FMM-100BB-R Surface-mount Back Box. The alarm lever cam actuator latches when pulled and the reset is keyed. A scored acrylic break rod (P/N: FMM-100GR) is optional.

2.0 Installation

2.1 Wiring the Alarm Box to the FACP

For details on address programming and wiring, refer to the *FLM-325-IM Installation Instructions* (DWG# HA-06-269, Part# 1700-11730) and the *D5070 Programmer Operating Instructions* (DWG# HA-06-242, Part#1700-11460).

1. Set the device address on the FLM-325-IM.

 Set the FMM-325A/FMM-325A-D address on the FLM-325-IM before wiring the module and installing it in the back box. Once the pull station and point contact module are installed in the back box, setting or changing the address involves removing the device and opening the module case.

2. Connect the FLM-325-IM to the FACP as shown in Figure 1.

 Since the FLM-325-IM will be installed inside the back box, run the wires from the module to the FACP through an appropriate knockout on the back box.

Figure 1: FACP Wiring



- 1 - Back of FMM-100-S/FMM-100-D
- 2 - FLM-325-IM
- 3 - Wiring from pull station alarm contacts
- 4 - Data/power SLC common out (SC-)
- 5 - Data/power SLC positive out (S+)
- 6 - To next device or FACP
- 7 - 10 kΩ EOL resistor (Hochiki P/N: 0400-01046)

2.2 Installing the Pull Station in a Back Box

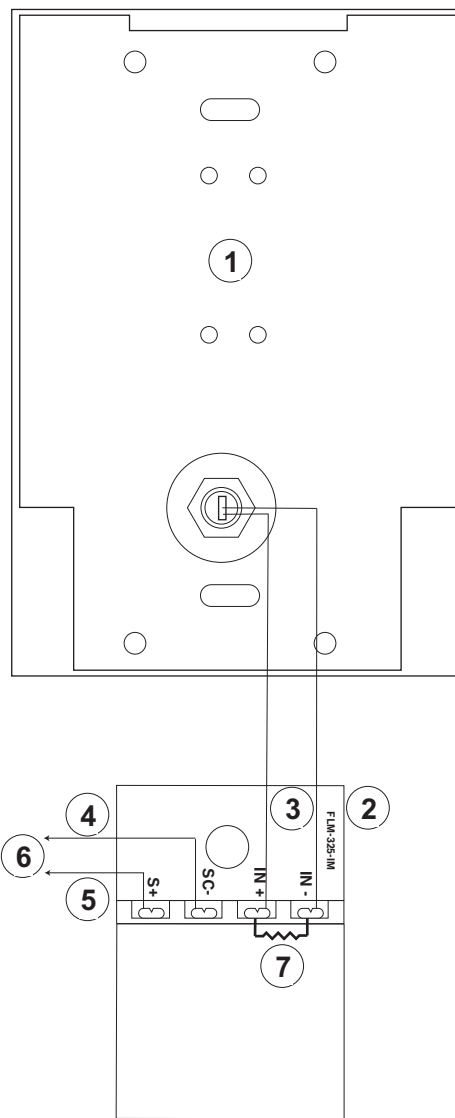
When the device address has been set and the wire connections from the FLM-325-IM to the FACP have been made, proceed with installing the manual pull station in the back box.

2.2.1 Flush Mounting in a Single-gang Back Box

1. Position the point contact module so that the hole in its mounting plate aligns with the upper attachment slot in the back plate of the manual pull station.
2. Use the screw provided with the back box to hold the back plate of the manual pull station and the point contact module to the upper mounting hole of the back box.

3. Use the other screw provided through the lower attachment slot of the back plate to firmly attach the manual pull station.
4. To install the optional glass rod, slip one end of the rod in the slot and under the spring tab. Lift the remaining tab and slide the other end of the rod into the slot.

Refer to Figure 2.

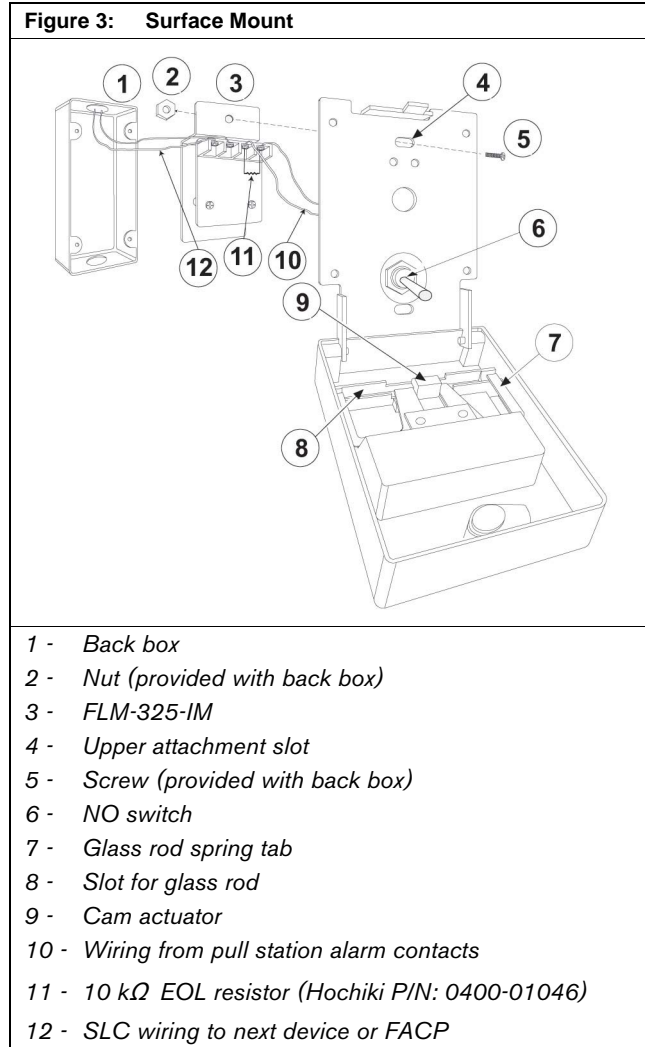
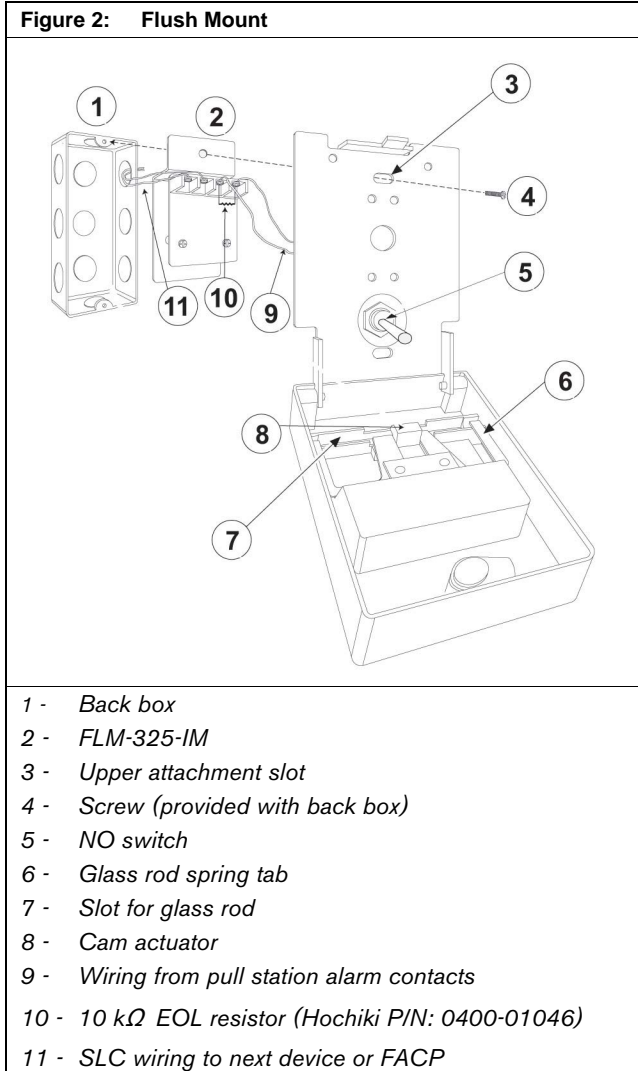

3.0 Specifications

Electrical	
SLC Applied Voltage (rated range):	25.3 VDC to 39 VDC
SLC Current Consumption:	Standby: 0.339 mA Alarm: 0.358 mA

Environmental	
Environment:	Indoor dry
Relative Humidity:	Up to 90% at 100°F, noncondensing
Temperature	Operating: 0°C to +49°C (+32°F to +120°F) Storage: -30°C to +70°C (-22°F to +158°F)

Mechanical	
Dimensions (HxWxD):	4.75 in. x 3.25 in. x 1.1 in. (120.65 mm x 82.55 mm x 27.94 mm)
Weight:	1.2 lb (0.54 kg)

2.2.2 Surface Mounting in an FMM-100BB-R Back Box

1. Use the screw and nut provided with the back box to attach the point contact module to the back plate of the manual pull station through the upper attachment slot. Ensure that the head of the screw not the nut will be inside the manual pull station.
2. Use the remaining four screws provided with the back box to attach the manual pull station to the back box.
3. To install the optional glass rod, slip one end of the rod in the slot and under the spring tab. Lift the remaining tab and slide the other end of the rod into the slot.

Refer to Figure 3.