



INSTALLATION AND OPERATION MANUAL

CL(T,R)VE(1,2)COAX[POE][/M]

ANALOG AND IP VIDEO OVER COAX

This manual serves the following ComNet Model Numbers:

CLTVE1COAX/M
CLRVE1COAX/M
CLTVE1COAXPOE/M
CLRVE1COAX
CLRVE2COAX

The ComNet™ CL(T,R)VE(1,2)COAX[POE][/M] is a communications link that combines composite analog baseband video and 10/100T(X) Ethernet on a single RG59 coaxial cable and transmits it up to 500 meters. The device is particularly suited to applications where the addition of IP Video to an existing analog video system is required. The CLTVE1COAXPOE/M model can provide power to the IP device via PoE.

LED indicators are provided for rapidly ascertaining the operating status of the device. See **Figure 6** on **Page 5** for an explanation of the LED Indicators.

Packaged in a rugged, compact sized housing, these units are designed for surface or stand-alone mounting, or may be DIN-rail mounted by the addition of ComNet model DINBKT2 Adaptor plate kit. Refer to **Installation Considerations** on **Page 5** and **Figure A** on **Page 6** for mounting instructions.

See **Figures 1 - 6** for complete installation instructions.

FIGURE 1 - CLTVE1COAX/M TRANSMITTER

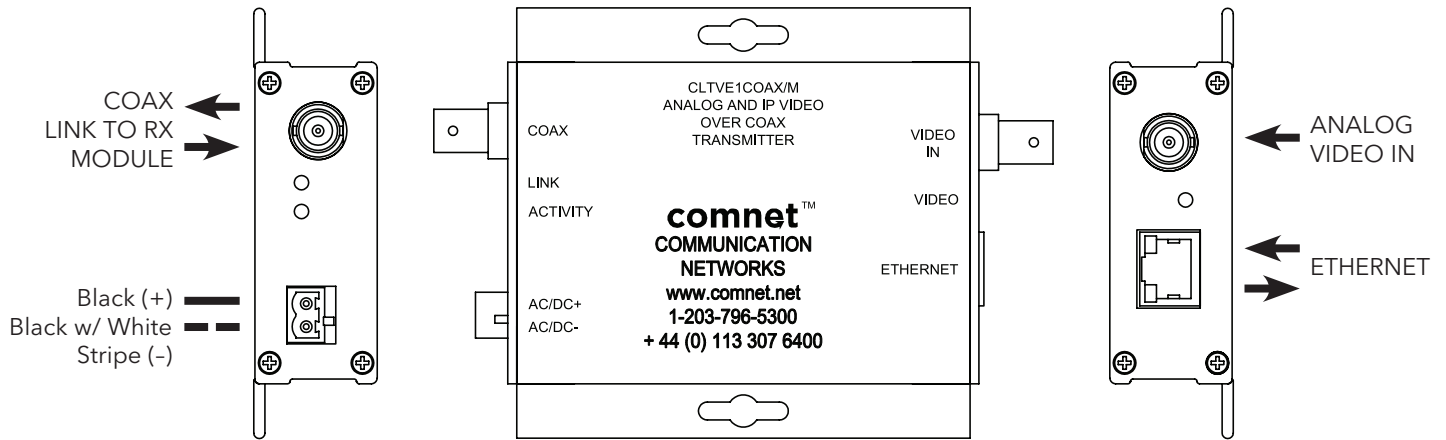

Operating Power: 12 to 36 VDC or 24 VAC
 Power Consumption: 2W

FIGURE 2 - CLRVE1COAX/M RECEIVER

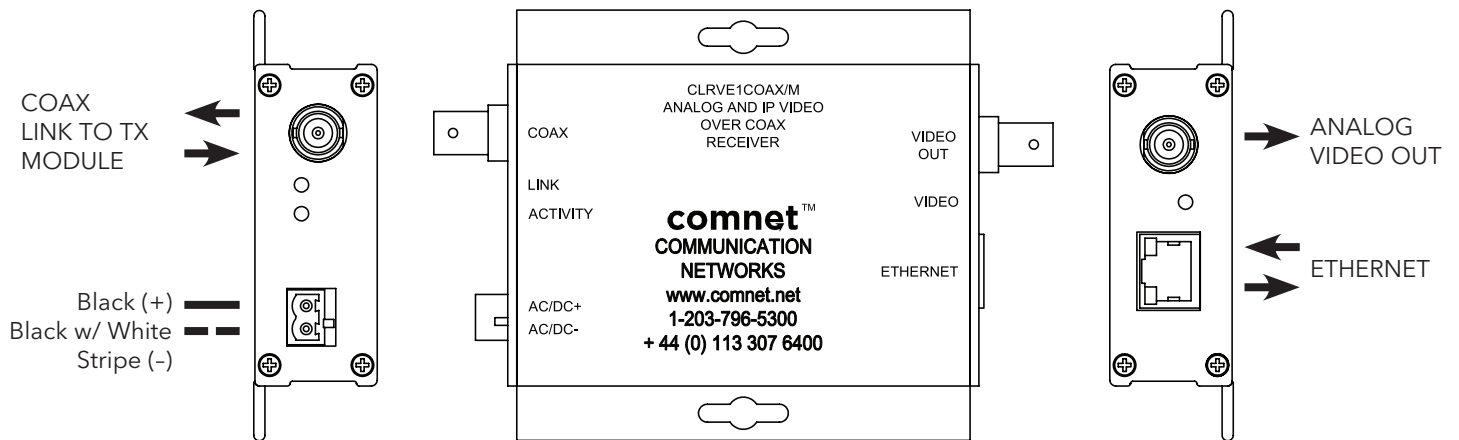

Operating Power: 12 to 36 VDC or 24 VAC
 Power Consumption: 2W

FIGURE 3 - CLTVE1COAXPOE/M TRANSMITTER WITH POE

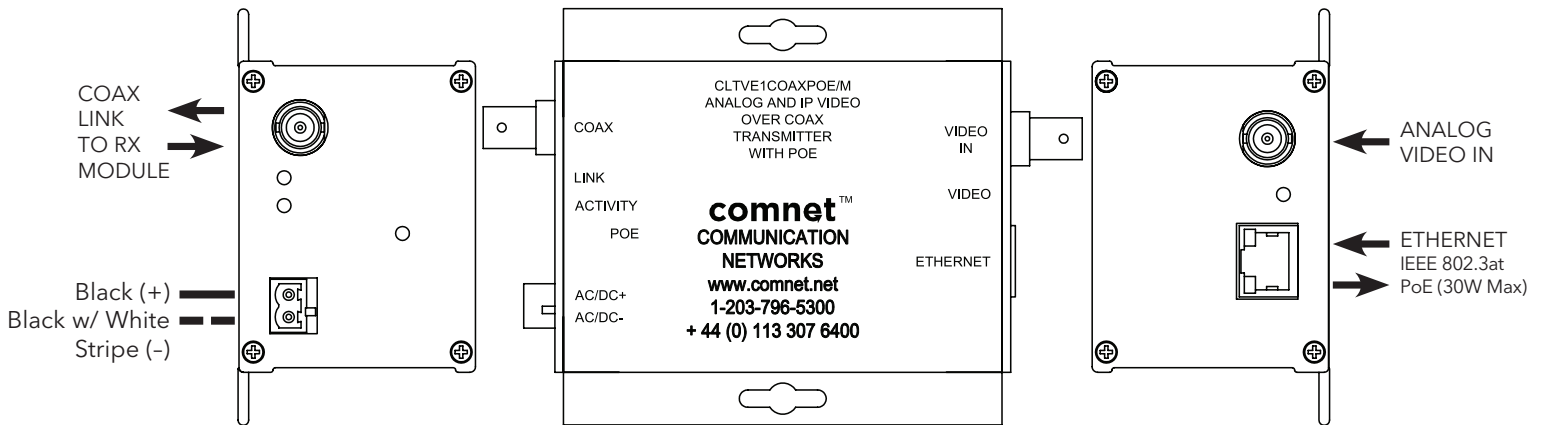

Operating Power: 12 to 36 VDC or 24 VAC
 Power Consumption: 2W

Note: Power consumption does not include that of Powered Device(s) (PD)

FIGURE 4 - CLRVE1COAX RECEIVER

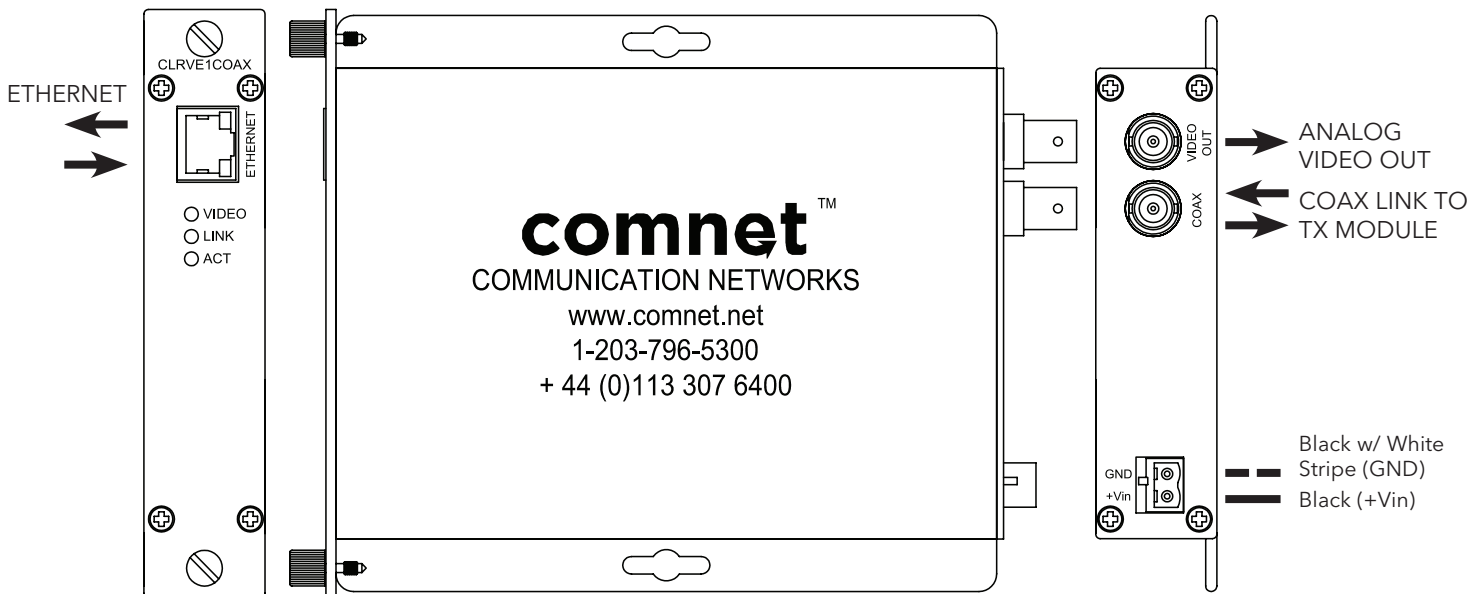

Operating Power: 9 to 18 VDC
 Power Consumption: 2W

FIGURE 5 - CLRVE2COAX RECEIVER

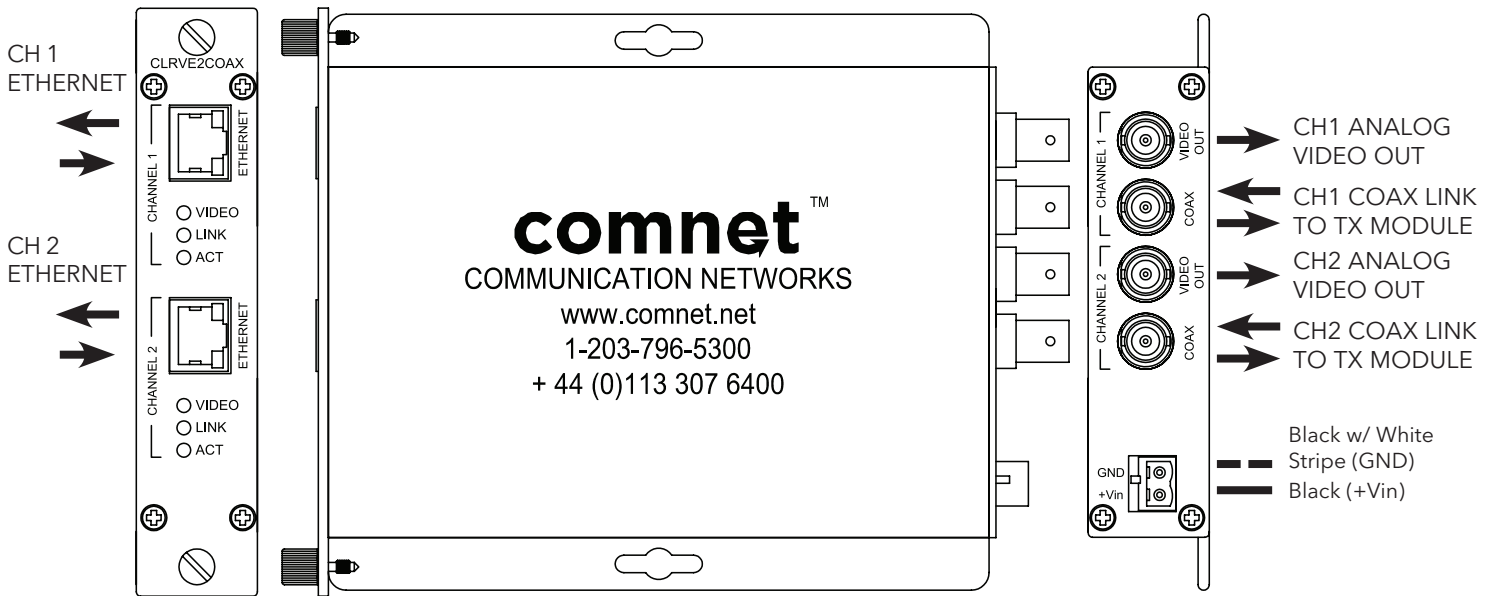

Operating Power: 9 to 18 VDC
 Power Consumption: 4W

FIGURE 6 - INDICATING LEDS

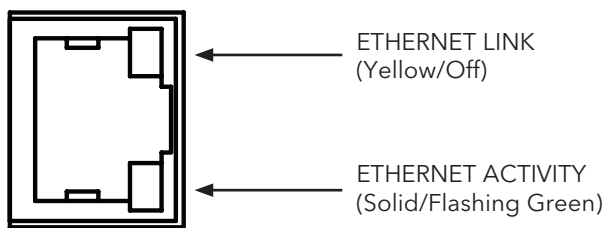

ETHERNET

	GREEN	YELLOW	RED	OFF
COAX LINK	Coax interface linked	N/A	Coax Interface Not Linked	Unit Powered Down
COAX ACTIVITY	Activity detected (flashing or solid)	N/A	N/A	No Activity
POE (CLTVE1COAXPOEM/M)	PoE power is being supplied.	N/A	N/A	PoE is not supplied.
VIDEO DETECT	Video signal detected on the Video BNC	N/A	No Video signal detected on the Video BNC	Unit Is Powered Down.
ETHERNET LINK	N/A	Interface Linked	N/A	Interface Not Linked
ETHERNET ACTIVITY	Activity Detected	N/A	N/A	No Activity Detected

Installation Considerations

This Ethernet unit is supplied as a Standalone/Rack module. Units should be installed in dry locations protected from extremes of temperature and humidity.

C1-US, C1-EU, C1-AU or C1-CH Card Cage Racks

CAUTION: Although the units are hot-swappable and may be installed without turning power off to the rack, ComNet recommends that the power supply be turned off and that the rack power supply is disconnected from any power source. Note: Remove electrical connector before installing in card cage rack.

1. Make sure that the card is oriented right side up, and slide it into the card guides in the rack until the edge connector at the back of the card seats in the corresponding slot in the rack's connector panel. Seating may require thumb pressure on the top and bottom of the card's front panel.

CAUTION: Take care not to press on any of the LEDs.

2. Tighten the two thumb screws on the card until the front panel of the card is seated against the front of the rack.

WARNING: Unit is to be used with a Listed Class 2 power supply.

IMPORTANT SAFEGUARDS:

A) Elevated Operating Ambient - If installed in a closed or multi-unit rack assembly, the operating ambient temperature of the rack environment may be greater than room ambient. Therefore, consideration should be given to installing the equipment in an environment compatible with the maximum ambient temperature (T_{ma}) specified by the manufacturer.

B) Reduced Air Flow - Installation of the equipment in a rack should be such that the amount of air flow required for safe operation of the equipment is not compromised.

FIGURE A

Dimensions are for a standard ComNet™ one slot module

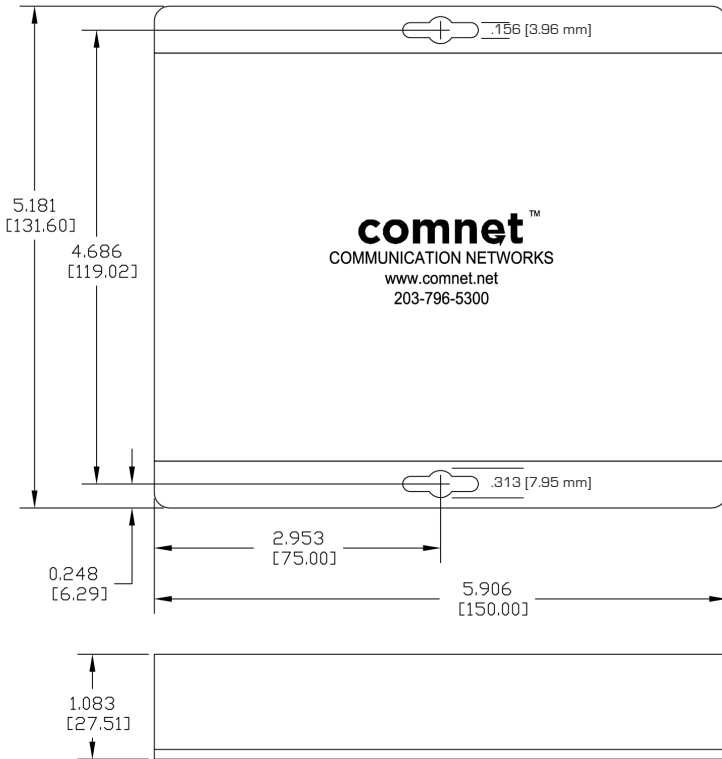

FIGURE B

Dimensions are for a small size ComNet™ surface mount module

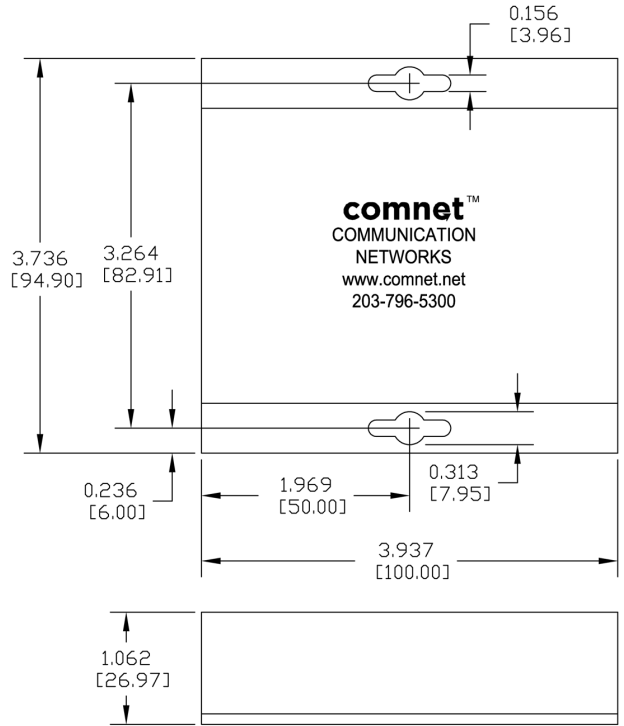
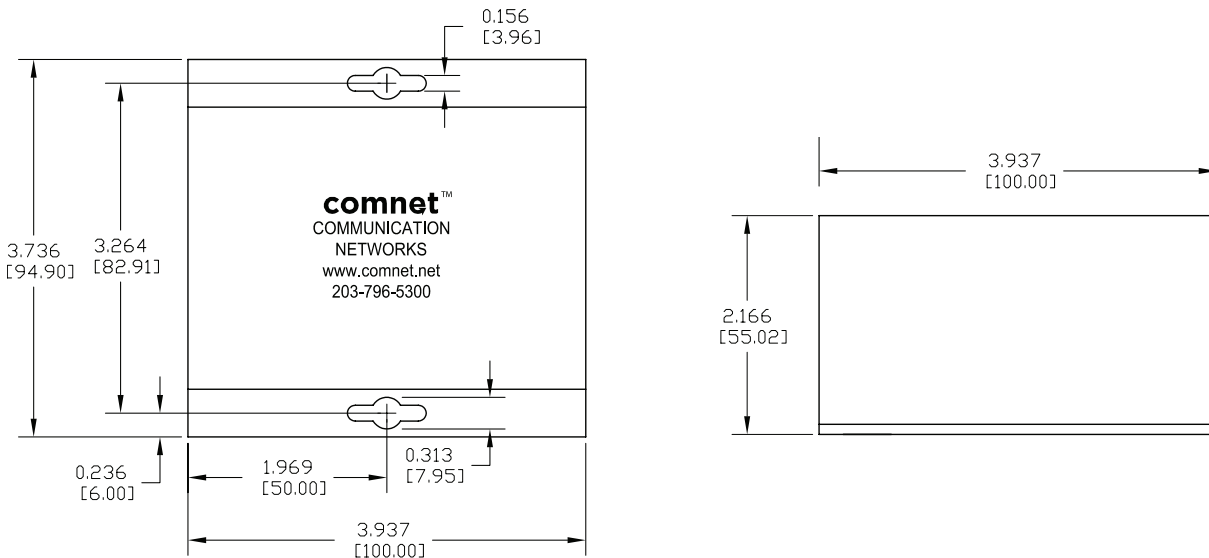

FIGURE C

Dimensions are for a two-high small size ComNet™ surface mount module



comnet
Communication Networks

3 CORPORATE DRIVE | DANBURY, CT 06810 | USA
T: 203.796.5300 | F: 203.796.5303 | TECH SUPPORT: 1.888.678.9427 | INFO@COMNET.NET
8 TURNBERRY PARK ROAD | GILDERSOME | MORLEY | LEEDS, UK LS27 7LE
T: +44 (0)113 307 6400 | F: +44 (0)113 253 7462 | INFO-EUROPE@COMNET.NET

MADE IN THE
USA