

User's Guide

TRENDNET[®]



10dBi Wireless N300 Outdoor PoE Access Point

TEW-740APB0

Contents

Product Overview	4
Package Contents	4
Features	4
Product Hardware Features.....	5
Application Diagram	7
Setup & Installation	8
Note the Wireless MAC Addresses.....	8
Setup Guide Assumed Defaults	8
TEW-740APBO #1 Configuration	9
TEW-740APBO #2 Configuration	11
Verify Point-to-Point Configuration/Connectivity	12
Grounding Wire Installation	13
Waterproof Kit Installation	13
Mounting Hardware Installation	16
Pole Mounting	16
Wall Mounting	17
Completed Point to Point Setup and Pole Mount Installation Example.....	18
Installation Tips.....	19
Application Modes	20
AP Mode (Access Point Mode)	20
WDS Mode (Pure WDS)	21
Client Bridge + Universal Repeater Mode	22
CPE + AP Mode (Router Client + Access Point)	22
AP Mode Configuration	23
External Network Connection.....	23
Network Requirement	23

Configure LAN IP	23
Wireless LAN Network.....	25
Wireless General Setup	25
Wireless Advanced Setup	25
Wireless WMM QoS Setup	27
Create Virtual AP (VAP)	29
Virtual AP Setup.....	30
Wireless MAC Filter Setup	32
Wireless Network Expansion	32
System Status	33
System Overview	33
Associated Clients Status.....	34
Show WDS Link Status	34
Extra Information.....	35
Event Log	36
WDS Mode Configuration	37
External Network Connection	37
Network Requirement	37
Configure LAN IP	37
Wireless Network Expansion	38
Wireless General Setup	38
Wireless Advanced Setup	39
Wireless WMM QoS Setup	40
WDS Setup	42
System Status	42
System Overview	42
Extra Information.....	43
Event Log	44
WDS Link Status.....	45
Repeater Mode.....	46
External Network Connection	46
Network Requirement	46

Configure LAN IP	46	Access Control	74
Wireless Network Expansion	47	DMZ	74
Wireless General Setup	47	IP Filter Setup	74
Wireless Advanced Setup	48	MAC Filter Setup.....	75
Wireless WMM QoS Setup	50	Virtual Server.....	75
Site Survey	51	Bandwidth Control.....	76
Repeater AP Setup	52	Routing	76
Wireless MAC Filter Setup	54	Status.....	76
Create Wireless Profile	54	System Overview	77
Bandwidth Control.....	56	DHCP Client.....	77
Configure SNMP Setup	56	Extra Information.....	78
Configure Time Policy	57	Event Log	79
System Status	58	Associated Client List	79
System Overview	58	Remote AP status	79
DHCP Client.....	59	System Management	81
Extra Information.....	59	Configure Management.....	81
Event Log	60	Configure System Time.....	82
Associated Client List	60	Configure SNMP Setup	82
Remote AP status.....	61	Enable UPNP	83
CPE + AP Mode Configuration.....	61	Backup / Restore and Reset to Factory	83
External Network Connection.....	61	Firmware Upgrade.....	84
Network Requirement	61	Network Utility	84
Configure CPE Setup	62	Reboot	85
Configure DDNS Setup	63	Technical Specifications	86
Configure LAN IP	63	Appendix	88
Configure Static IP address	65		
Access Point Association.....	65		
Wireless General Setup	65		
Wireless Advanced Setup	66		
Wireless WMM QoS Setup	67		
Site Survey	69		
Create Wireless Profile	69		
AP Setup.....	71		
Wireless AP MAC Filter Setup	73		

Product Overview



TEW-740APBO

Package Contents

- TEW-740APBO
- CD-ROM (Software & User's Guide)
- Quick Installation Guide
- Power adapter (48V DC, 0.5A)
- Proprietary PoE injector
- Waterproof RJ-45 kit
- Grounding wire
- Mounting hardware

Features

TRENDnet's 10dBi Wireless N300 Outdoor PoE Access Point, model TEW-740APBO, provides Wireless N300 building-to-building connectivity. A variety of installation scenarios are facilitated with Access Point (AP), Wireless Distribution System (WDS), Repeater, and CPE + AP modes. The IP67 rated housing comes with wall and pole mounting hardware.

Multi-Mode Support

Supports Access Point (AP), Wireless Distribution System (WDS), Repeater, and Wireless Client modes

Wireless N300 (2.4 GHz)

Compliant with 802.11n/g/b technology (2.4 GHz) with data rates up to 300 Mbps*

Outdoor Rated

Durable enclosure with an IP67 outdoor weather rating

Directional Antenna

Built in 10 dBi directional antenna

Power over Ethernet (PoE)

Comes with a proprietary PoE injector, so that it can connect a regular non-PoE switch

Logs

Real time logs and statistics help troubleshooting

Encrypted Wireless

Support for wireless encryption of up to WPA2

Multiple SSIDs

Create up to eight additional SSIDs

Compatibility

Compatible with legacy wireless devices

Mounting Hardware

Pole and wall mount hardware included

* Effective wireless coverage may vary depending on the wireless device's output power, antenna gain, antenna alignment, receiving sensitivity, and radio interference. Additionally environmental factors such as weather conditions, physical obstacles, and other considerations may affect performance. For optimal results, we recommended consulting a professional installer for site survey, safety precautions, and proper installation.

Product Hardware Features

Front View



Bottom View

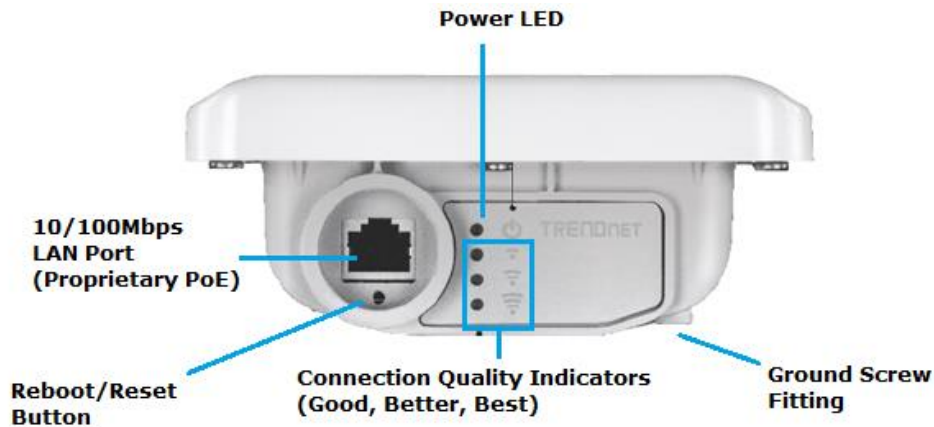

- **Reboot/Reset Button** – You will need to unscrew the protective cover or disconnect the RJ-45 waterproof kit if it is installed to gain access to this button. Press and hold this button for 2 seconds and release to reboot the device. Press and hold this button for 10 seconds and release to reset the device to factory defaults.
- **Power LED** – The indicator will turn when the device is powered on.
- **WLAN Connection Quality Indicators** – The connection quality indicators will turn on depending on the connection quality during installation. These indicators can help to assist with optimal placement and positioning during mounting/hardware installation.

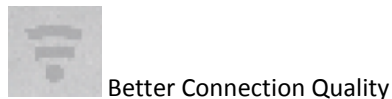

- **LAN Port** – You will need to unscrew the protective cover to gain access to this port. The Ethernet LAN port operates at 10/100Mbps and is also used to supply power to the device using only the included proprietary PoE injector.
- **Proprietary PoE Injector** –
 - **POWER IN** – Connect the included power adapter connector to this input and adapter side into an AC power source to supply power to the injector.
 - **P+DATA OUT** – Connect an Ethernet RJ-45 cable to this output and the other side to the device LAN port to supply power to the device.
 - **10/100 DATA IN** – Connect an Ethernet RJ-45 cable to this input and connect the other to your network or directly to computer for initial device setup.

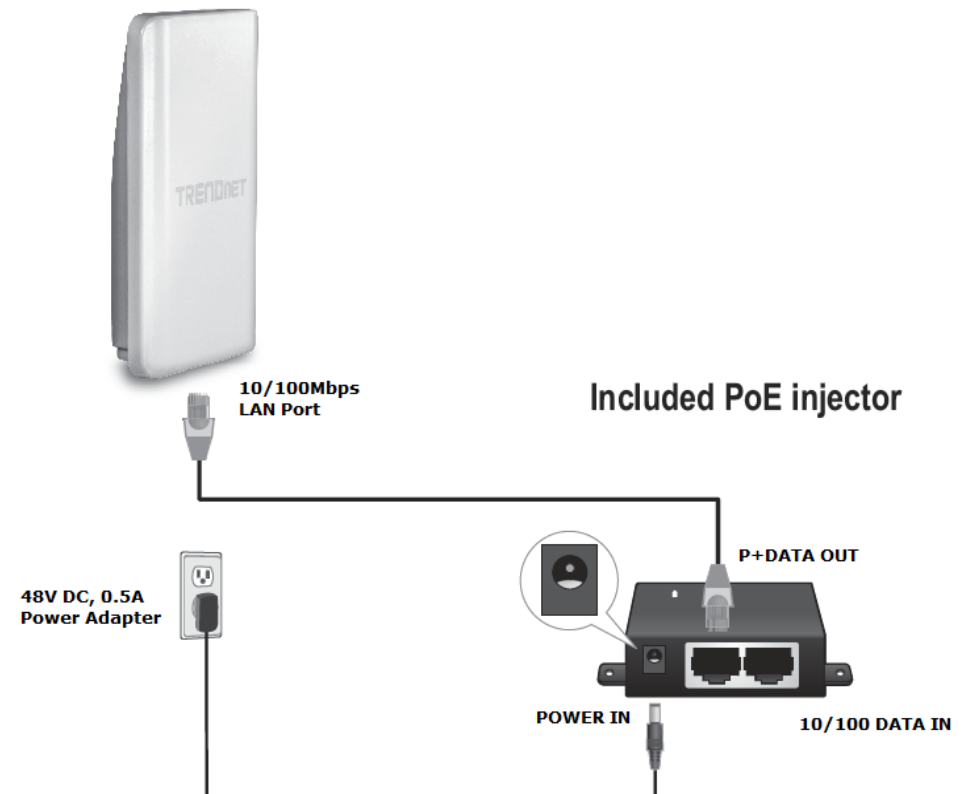

- Ground Screw Fitting** – The ground screw is built into the device housing. The fitting can be identified on the back of the housing by checking for the ground symbol. The included ground screw and wire can be used to attached the device to a known grounding point. (ex. Earth driven rod, grounded electrical system, building frame, etc.)

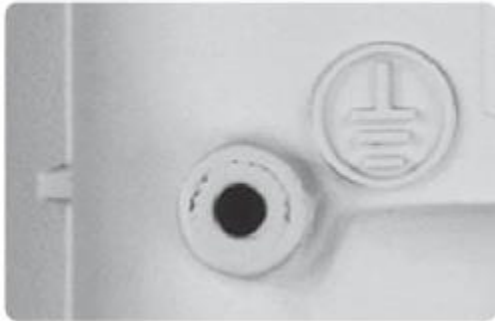

Application Diagram

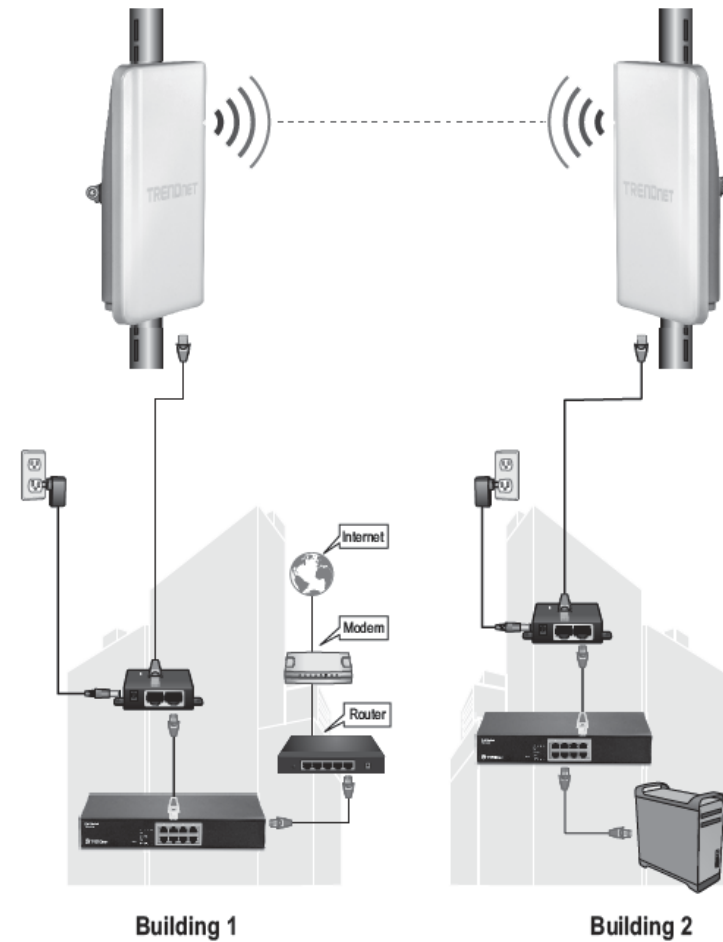

The example application displays two TEW-740APBO access points are configured in WDS point-to-point bridge mode and establishing a wireless link between each and other, allowing for network connectivity between two buildings over a point-to-point wireless link.

Setup & Installation

The intended purpose and application for this product is to extend network connectivity across long physical distances outside of an area or building that lacks local connectivity using point to point wireless bridge capability using 802.11 standards.

Although this product supports multiple wireless modes, the basic installation will only cover the primary application of point to point wireless connectivity.

Minimum Requirements

- Computer with RJ-45 Ethernet port and web browser
- 2 x RJ-45 Ethernet cables (not included)
- Phillips screwdriver (not included)

Important Note:

The access point does not support standard IEEE 802.3at/af PoE/PoE+. Only the included proprietary PoE injector may be used to supply power to the access point. For safety, use only the included PoE injector to supply power to the access point.

It is strongly recommended that you configure the access points first before mounting them in their desired locations.

Access Point Default Settings

LAN IP Address: 192.168.10.100
 LAN Subnet Mask: 255.255.255.0
 User: admin
 Password: admin

The following steps assume you are setting up and installation two TRENDnet TEW-740APBO access points in point to point configuration.

Note the Wireless MAC Addresses

Please check the device label on both access points and write down or note the item labeled **MAC1** from both access points. **MAC1** is the wireless MAC address assigned to each access point and will be used later in the configuration steps.

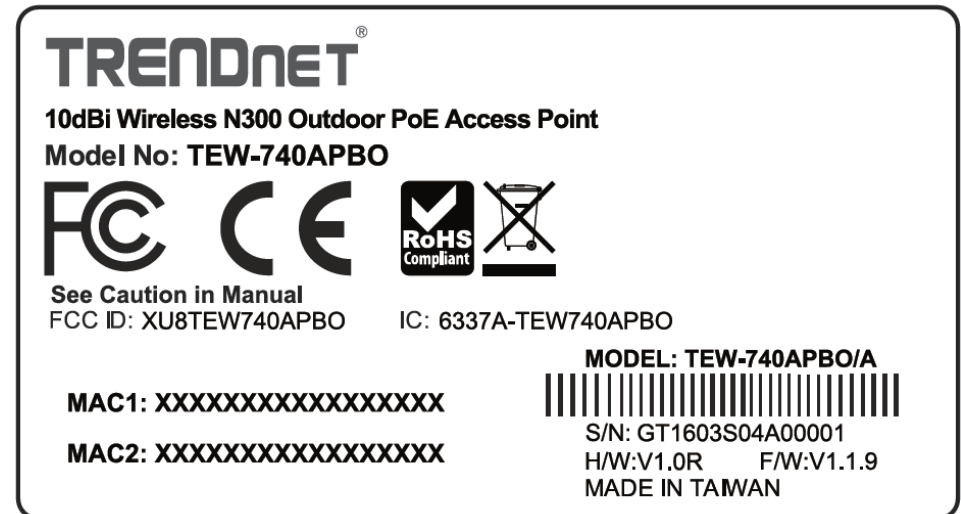

Setup Guide Assumed Defaults

In this guide, we will assume the following defaults and settings:

- TEW-740APBO #1 MAC1: 00:11:22:33:44:55
- TEW-740APBO #2 MAC1: AA:BB:CC:DD:EE:FF
- Network Router/Gateway IP Address/Netmask: 192.168.10.1 / 255.255.255.0
- Network Router/Gateway DHCP IP Pool: 192.168.10.101-192.168.10.199

Note: Please note that if your existing network router/gateway IP address/subnet settings are different than the network settings assumed above, you will need to modify the assigned IP configuration to each access point accordingly to within you specific subnet.

Before mounting the access points in their desired locations, please configure access points first.

TEW-740APBO #1 Configuration

1. Connect the power adapter connector side to the **POWER IN** on the included proprietary PoE injector and the adapter to an AC power source.
Note: EU model also include an on/off power switch. Please make sure to switch to the (On/-) position.
2. Connect an RJ-45 Ethernet cable from the access point LAN port to the **P+DATA OUT** on the included proprietary PoE injector.
3. Connect an RJ-45 Ethernet cable from the computer to the **10/100 DATA IN** on the included proprietary PoE injector.

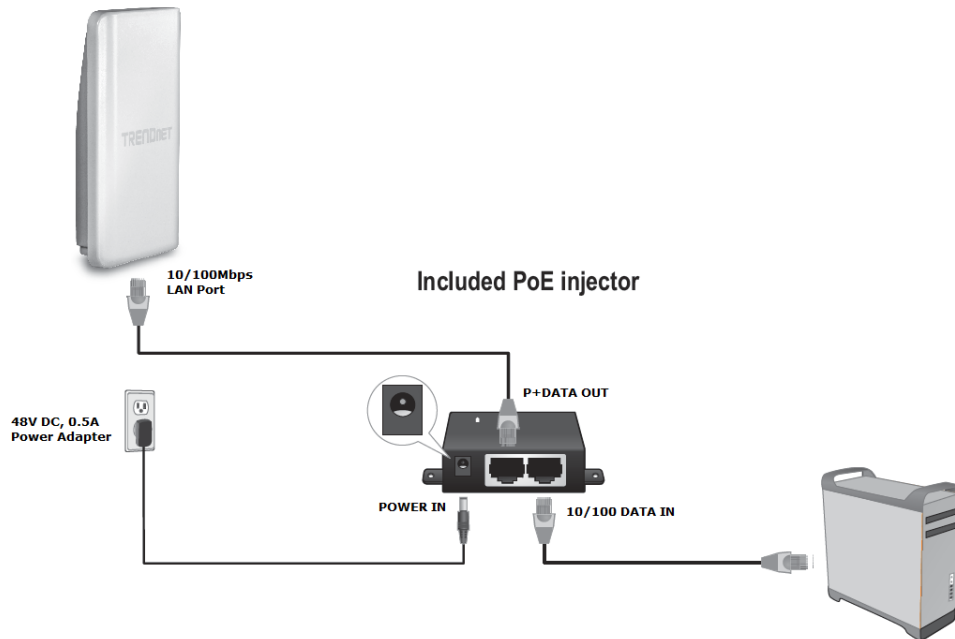

4. The access point power LED will turn on to indicate the device is receiving power.
5. Assign a static IP address to your computer network adapter in the subnet of 192.168.10.x (ex. 192.168.10.10) and subnet mask of 255.255.255.0.

6. Open your web browser and type in the IP address of the access point in the address bar, then press Enter. The default IP address of the access point is 192.168.10.100.

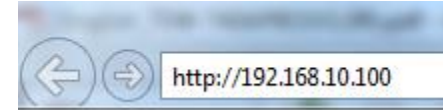

7. When prompted to login, enter the default user name and password and click **OK**.
Default User Name: **admin**
Default Password: **admin**



8. At the Password Setup page, enter your new password in the **New admin Password** field and once again in the **Check admin Password** field to confirm, then click **Save** to apply the new password settings.

Note: It is recommended to change to a strong admin password. This is the password that will be used to login to the access point management configuration web page.

admin Password	
New admin Password	<input type="text"/>
Check admin Password	<input type="text"/>
<input type="button" value="Save"/>	

9. In the access point management web page, click on **System** and click on **LAN**.

10. Under Static IP, enter the IP address settings below, then scroll down and click **Save** to apply the settings. After changes are applied, you will need to login to the new IP address assigned.

Note: Please note that if your existing network IP subnet is different. You must assign IP addresses available in your IP subnet to the access points accordingly.

TEW-740ABO #1 IP Configuration

IP Address: **192.168.10.50**

IP Netmask: **255.255.255.0**

IP Gateway: **192.168.10.1**

Static IP	
IP Address	<input type="text" value="192.168.10.50"/>
IP Netmask	<input type="text" value="255.255.255.0"/>
IP Gateway	<input type="text" value="192.168.10.1"/>

11. Click **System** and click on **Operating Mode**. In the list, select **WDS** and click on **Save & Reboot** to apply the settings.

Operating Mode
<input type="radio"/> AP Mode
<input type="radio"/> WDS Mode
<input type="radio"/> Repeater Mode
<input type="radio"/> CPE + AP
<input type="button" value="Save & Reboot"/>

12. Click on **Wireless** and click on **General**.

You can choose to change the **Channel** settings but they must match on both access points to establish a point-to-point WDS configuration. For this example, we will leave as the default channel 6. If you decide to change it, make sure to scroll down and click **Save** to apply the setting.

Channel	<input type="text" value="6 (2.437 Ghz)"/> <input type="button" value="Auto Scan"/>
---------	---

13. Click on **Wireless** and click on **Virtual AP**. For **VAP0**, click on **Edit**.

VAP	MAC Address	ESSID	Status	Security Type	MAC Filter Edit	MAC Filter Status	VAP Edit
VAP0	00:22:AA:00:12:0B	TRENDnet7400_2.4GHz	FW	Disabled	<input type="button" value="Edit"/>	Disable	<input type="button" value="Edit"/>

14. You can choose to change the **ESSID** (Wireless Network Name) settings but they must match on both access points to establish a point-to-point WDS configuration. For this example, we will leave as the default setting TRENDnet7400_2.4GHz.

ESSID	<input type="text" value="TRENDnet7400_2.4GHz"/>
-------	--

15. Under WDS Setup, set the **Service** setting to **Enable**.

WDS Setup	
Service	<input checked="" type="radio"/> Enable <input type="radio"/> Disable

16. In the first field for item 1, check the **Enable** option and in the **WDS Peer's MAC Address** fields, enter the MAC address of the 2nd TEW-740ABPO (TEW-740APBO #2 MAC1: AA:BB:CC:DD:EE:FF) noted earlier in this guide. Description field is optional.
Note: You will need to enter the wireless MAC address of your 2nd access point as the one below is only used as an example in this guide.

#	Enable	WDS Peer's MAC Address	Description
1	<input checked="" type="checkbox"/>	aa : bb : cc : dd : ee : ff	TEW-740ABO#2

17. In the **Security Type** field above, it is recommended to select **AES** and assign a passphrase. It is not required to create a point-to-point WDS link but strongly recommended. This setting must match on both access points.

Security Type	<input type="radio"/> Disable <input type="radio"/> WEP <input checked="" type="radio"/> AES
---------------	--

If you decide to apply encryption and assign a passphrase, select **AES**. Then scroll down to the bottom under the AES section and enter **Passphrase**. The security type and key must match on both access points. Then click **Save** to save the settings.

Note: It is strongly recommended to assign strong passphrase. We are only using the encryption key 1234567890 as an example in this guide.

AES	
Passphrase	1234567890

18. At the top of the page, click **Reboot**, then click the **Reboot** button on the GUI page to commit all of the changes. This completes the configuration for TEW-740APBO #1.

Press "[Reboot](#)" after all configurations to enable new setting.

TEW-740APBO #2 Configuration

- Repeat the same TEW-740APBO #1 configuration steps 1-9 for TEW-740ABPO #2.
- On the TEW-740APBO #1 configuration step 10, use the IP configuration settings below for TEW-740APBO #2.

Note: Please note that if your existing network IP subnet is different. You must assign IP addresses available in your IP subnet to the access points accordingly.

TEW-740ABO #2 IP Configuration

IP Address: **192.168.10.51**

IP Netmask: **255.255.255.0**

IP Gateway: **192.168.10.1**

Static IP	
IP Address	192.168.10.51
IP Netmask	255.255.255.0
IP Gateway	192.168.10.1

- Repeat the same TEW-740APBO #1 configuration steps 11-15 for TEW-740ABPO #2.
- On the TEW-740APBO #1 configuration step 16, enter the MAC address of the 1st TEW-740ABPO (TEW-740APBO #1 MAC1: 00:11:22:33:44:55) noted earlier in this guide. Description field is optional.
Note: You will need to enter the wireless MAC address of your 1st access point as the one below is only used as an example in this guide.

#	Enable	WDS Peer's MAC Address	Description
1	<input checked="" type="checkbox"/>	00 : 11 : 22 : 33 : 44 : 55	TEW-740ABO#1

- Repeat the same TEW-740APBO #1 configuration steps 11-18 to complete the TEW-740ABPO #2 configuration. This completes the configuration for TEW-740APBO #2

Verify Point-to-Point Configuration/Connectivity

1. Make sure both access points (TEW-740APBO #1 and TEW-740APBO #2) powered on and positioned pointing toward each other.
2. With the static IP address still assigned from the setup guide, connect your computer to one of the access points via LAN port.

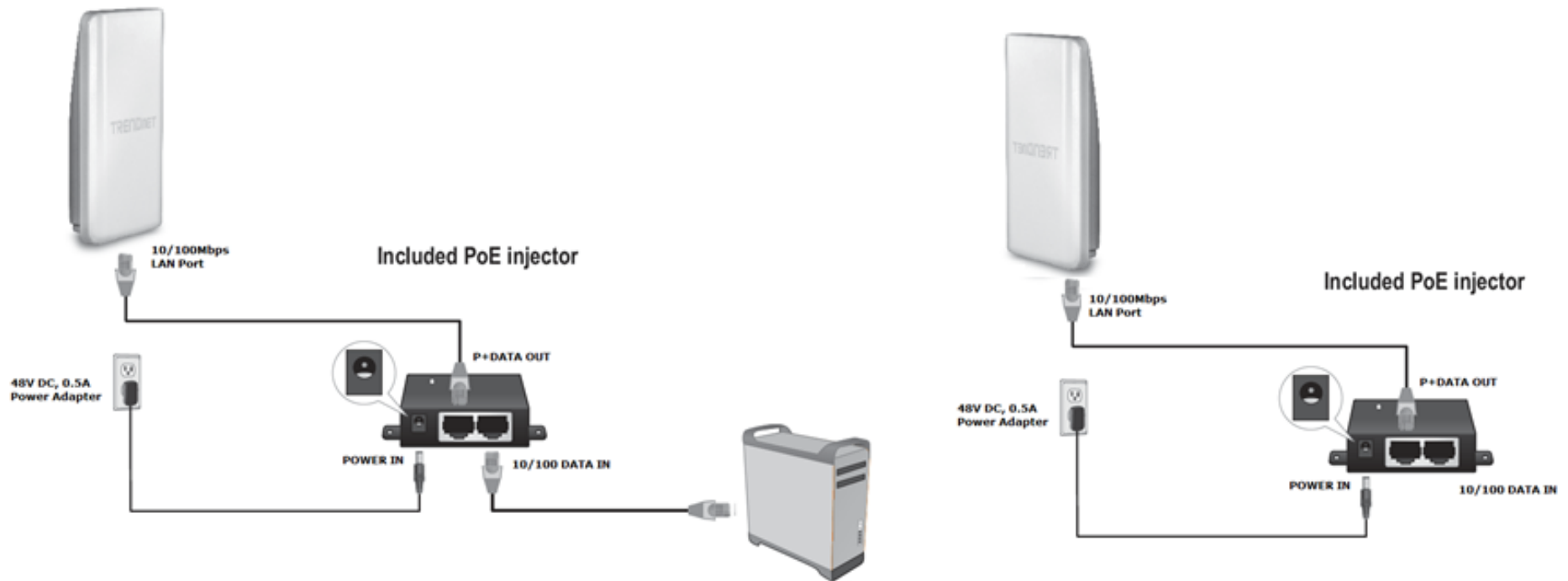

3. On your computer, open a command prompt/terminal window and run a ping command to test connectivity to both access point IP addresses 192.168.10.50 and 192.168.10.51. Example of successful ping replies below from both access points. You can also check if you can access both access point web management pages through a web browser.

```
C:\Users\trendnet>ping 192.168.10.50
```

```
Pinging 192.168.10.50 with 32 bytes of data:
```

```
Reply from 192.168.10.50: bytes=32 time<1ms TTL=128
```

```
Reply from 192.168.10.50: bytes=32 time<1ms TTL=128
```

```
C:\Users\trendnet>ping 192.168.10.51
```

```
Pinging 192.168.10.51 with 32 bytes of data:
```

```
Reply from 192.168.10.51: bytes=32 time<1ms TTL=128
```

```
Reply from 192.168.10.51: bytes=32 time<1ms TTL=128
```

Grounding Wire Installation

To install the grounding wire, align one end of the ground wire over the ground fitting, then secure the wire using the included screw and washer as shown below.



Waterproof Kit Installation

1. Unscrew the sealing nut from the main body.
2. Separate rubber seal from the claw.
3. Verify that you have the following parts as shown below:
 - Cable Gland
 - Seal
 - Claw
 - Sealing Nut

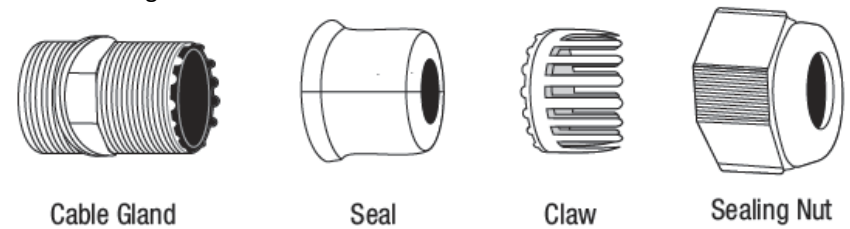

4. Insert one end of an Ethernet cable into the sealing nut.

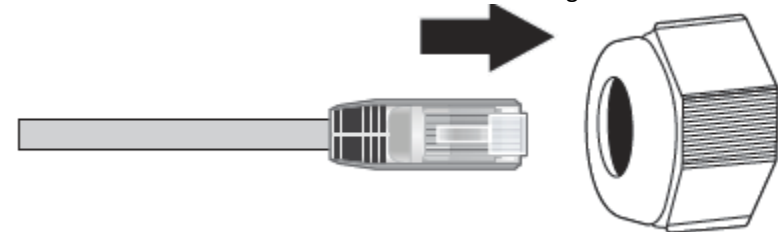

5. Insert the Ethernet cable into the seal.

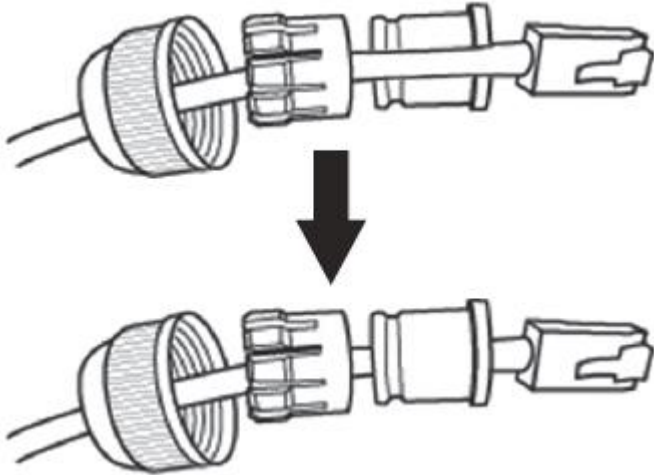

6. Insert the seal into the claw.

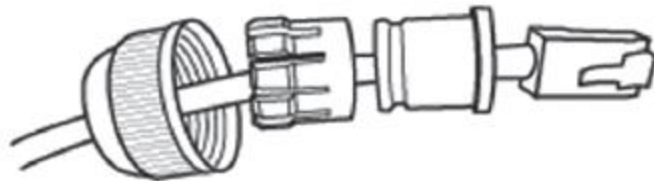

7. Insert the seal/rubber claw into the cable gland.

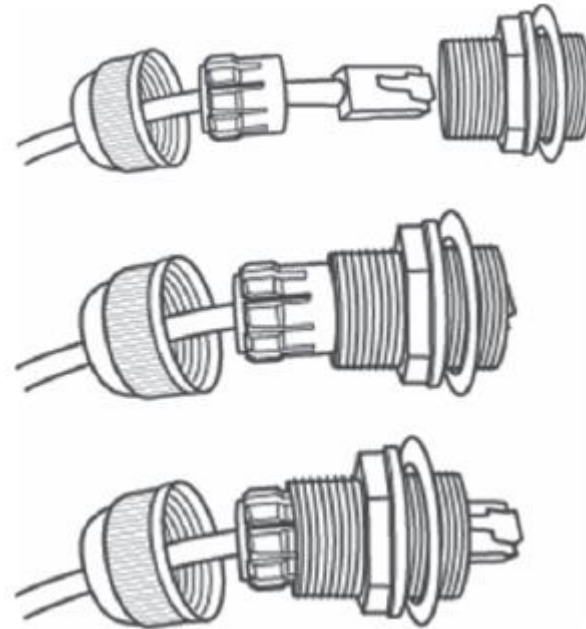

8. Connect the Ethernet cable to the LAN port on the bottom of the access point.

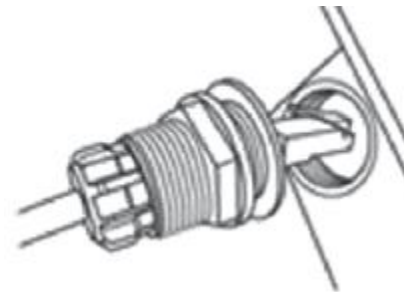

9. Fasten and tighten the plug to the housing of the access point.

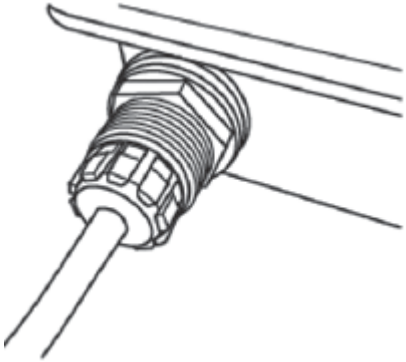

10. Fasten and tighten the cap to the weather proof plug.



Mounting Hardware Installation

Pole Mounting

Note: The pole mounting clamp supports poles with a maximum diameter of 101 mm (3.98 in.)

1. Align the mounting bracket with the hole on the unit and secure it with the M6x8 screw and washer provided.
2. Slide the two provided pole mounting clamps around the pole. Place the mounting bracket at the desired height and position.
3. Secure the TEW-740APBO to the pole mounting bracket using mounting clamp screws.



4. Adjust the orientation of the access point as necessary.



Wall Mounting

1. Align the mounting bracket with the hole on the unit and secure it with the M6x8 screw and washer provided.

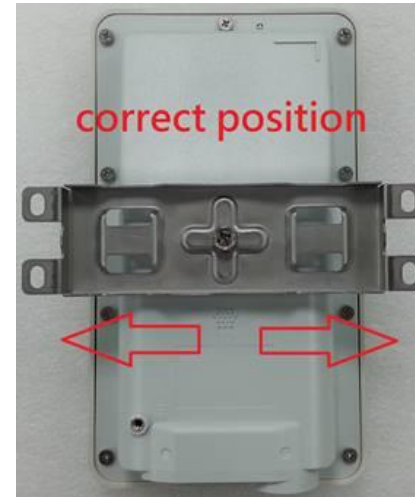

2. Position the provided mounting bracket to the desired location and wall mount with screws or fasteners using the four mounting bracket holes.



Completed Point to Point Setup and Pole Mount Installation Example

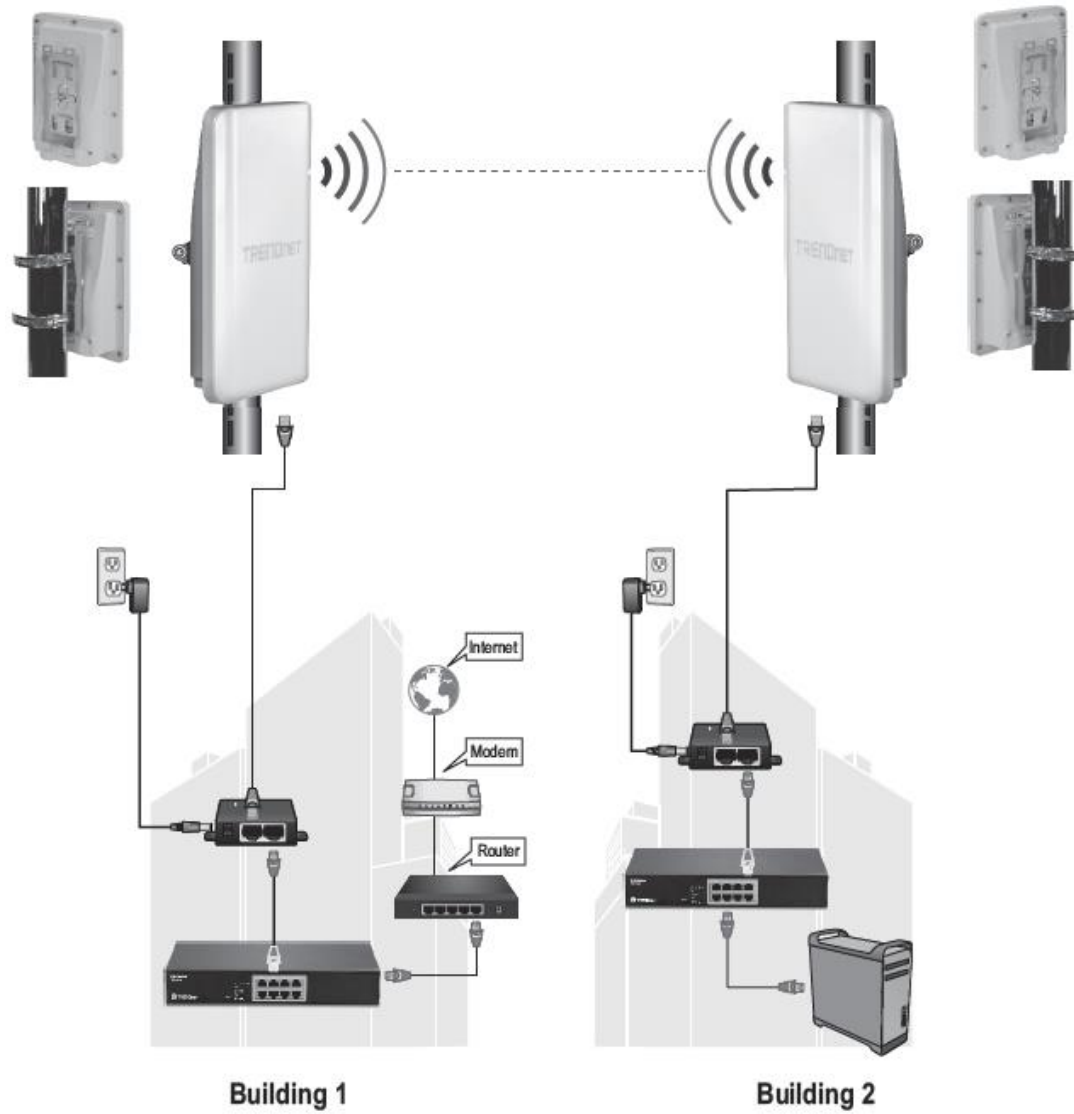

Installation Tips

There are a number of factors that can impact the range of wireless devices.

1. Adjust your wireless devices so that the signal is traveling in a straight path, rather than at an angle. The more material the signal has to pass through the more signal you will lose.
2. Keep the number of obstructions to a minimum. Each obstruction can reduce the range of a wireless device. Position the wireless devices in a manner that will minimize the amount of obstructions between them.
3. Building materials can have a large impact on your wireless signal. In an indoor environment, try to position the wireless devices so that the signal passes through less dense material such as dry wall. Dense materials like metal, solid wood, glass or even furniture may block or degrade the signal.
4. Antenna orientation can also have a large impact on your wireless signal. Use the wireless adapter's site survey tool to determine the best antenna orientation for your wireless devices.
5. Interference from devices that produce RF (radio frequency) noise can also impact your signal. Position your wireless devices away from anything that generates RF noise, such as microwaves, radios and baby monitors.

If you are still experiencing low or no signal consider repositioning the wireless devices or installing additional access points. The use of higher gain antennas may also provide the necessary coverage depending on the environment. Please note to use the wireless connection quality indicators during installation to determine the optimal positioning when mounting your access points.

Application Modes

Although the access point is intended to be used for WDS point-to-point bridging, the access point offers other operating modes. The access point multiple mode system which can be configured either as a wireless gateway or an access point as desired. It also can be used as a WDS (Wireless Distribution System) link for Ethernet network expansion. This section depicts different applications on **Router AP Mode**, **AP Mode**, **WDS Mode**, **CPE Mode**, **Client Bridge + Universal Repeater Mode** and **CPE + AP Mode**.

The different modes can be found under *System > Operating Mode* in the access point web management page.

AP Mode (Access Point Mode)

An access point can be either a main, relay or remote base station. A main base station is typically connected to a wired network via the Ethernet port. A relay base station relays data between main base stations and relay stations or remote base stations with clients. A remote base station is the end point to accept connections from wireless clients and pass data upstream to a network wirelessly.

Example 1: Access Point Only

- It can be deployed as a traditional fixed wireless access point.

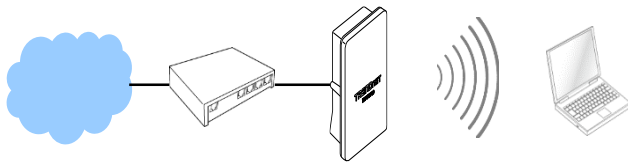

Example 2: Access Point + WDS Bridging

- It can be deployed as a traditional fixed wireless access point and establish WDS bridging to an upstream access point to expand a network.

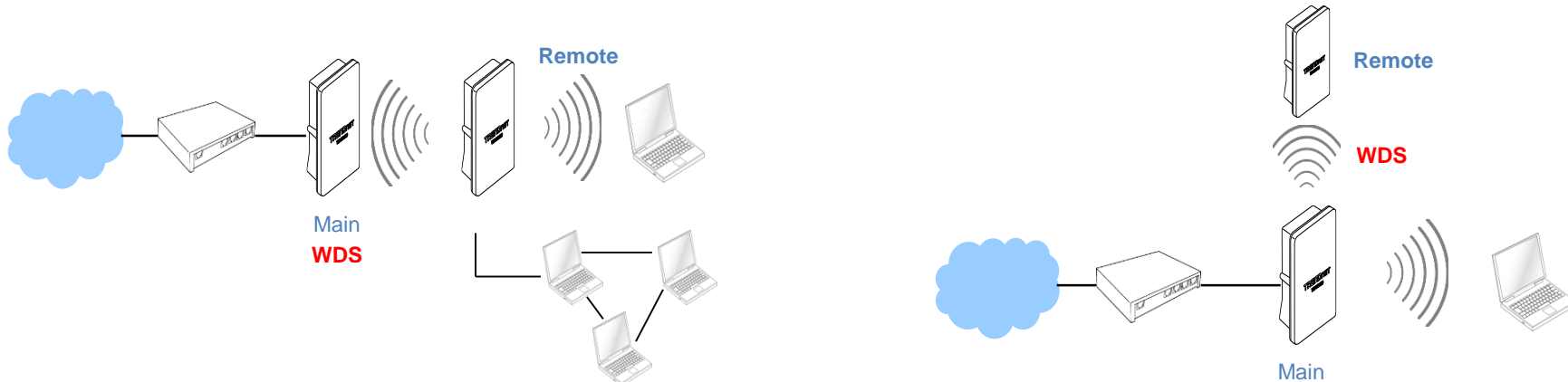

WDS Mode (Pure WDS)

An access point can be either a main, relay or remote base station. A main base station is typically connected to a wired network via the Ethernet port. A relay base station relays data between main base stations and relay stations or remote base stations with clients. A remote base station is the end point to accept connections from wireless clients and pass data upwards to a network wirelessly. In this mode, it can support single or multiple WDS links and no wireless clients can associate with it.

Example 1: Point-to-Point

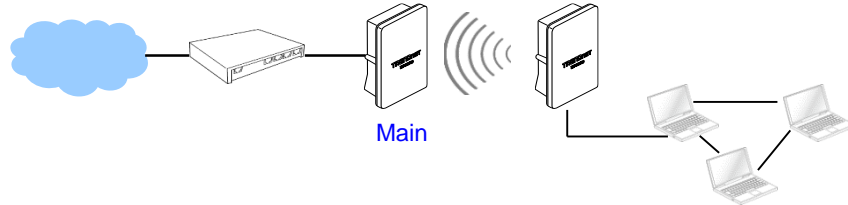
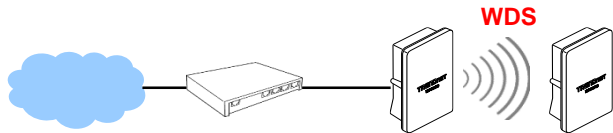

Example 2 : Point-to-Multi-Point

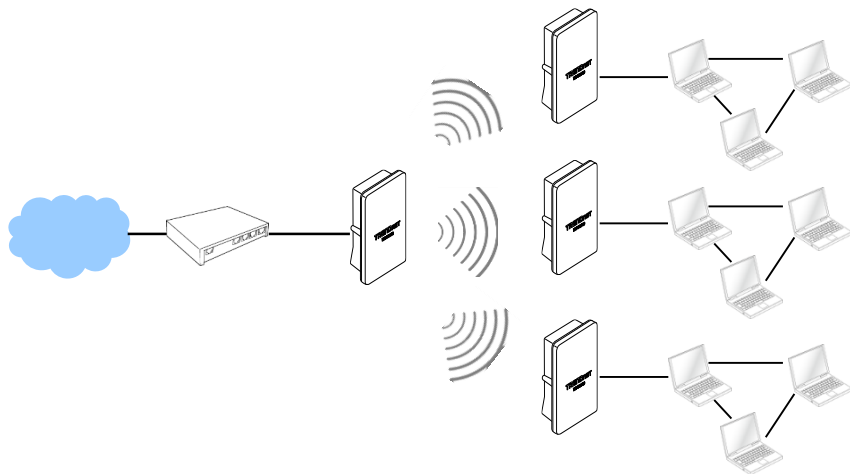

Example 3 : Multi-Point Repeating bridge

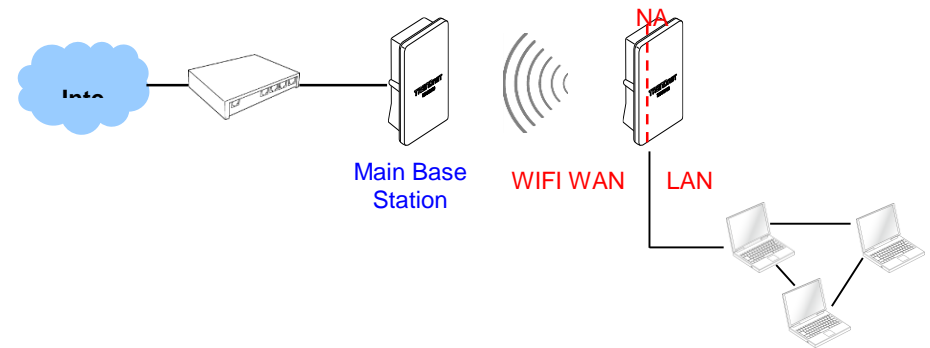

Client Bridge + Universal Repeater Mode

It can be used as a Client Bridge + Universal Repeater to receive wireless signal over last mile applications, helping WISPs deliver wireless broadband Internet service to new residential and business customers. In this mode, the access point is enabled with DHCP Server functions. The wired clients of access point are in the same subnet from Main Base Station and **it accepts wireless** connections from client devices.

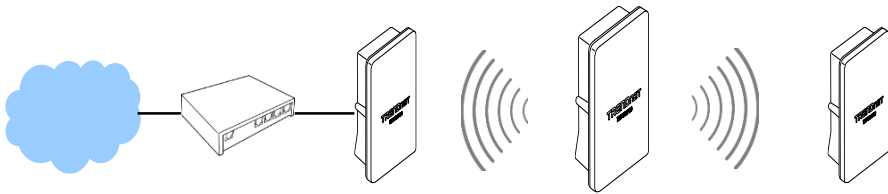

CPE + AP Mode (Router Client + Access Point)

It can be used as an Outdoor Customer Premised Equipment (CPE) to receive wireless signal over the last mile, helping WISPs deliver wireless broadband Internet service to new residential and business customers. In this mode, the access point is a gateway with NAT and DHCP Server functions. The wireless and wired clients of access point are on the different subnet from Main Base Station and it accepts wireless connections from client devices.

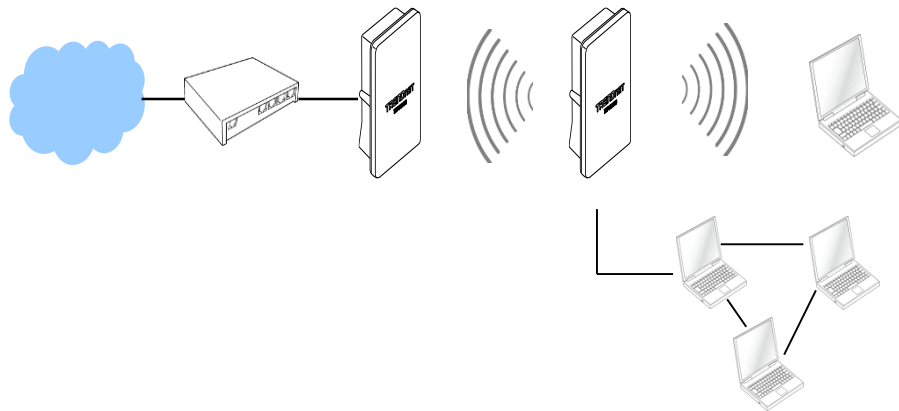

AP Mode Configuration

When AP mode is chosen, the system can be configured as an Access Point. This section provides detailed explanation for users to configure in the AP mode with help of illustrations. In the AP mode, functions listed in the table below are also available from the Web-based GUI interface.

External Network Connection

Network Requirement

Normally, access point connects to a wired LAN and provides a wireless connection point to associate with wireless client as shown in Figure 3-1. Then, Wireless clients could access to LAN or Internet by associating themselves with the access point set in AP mode.

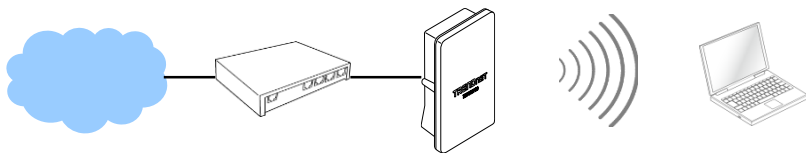

Configure LAN IP

Here are the instructions to setup the local IP Address and Netmask. Please click on **System** -> **LAN** and follow the below setting.

- **Mode:** Check either "Static IP" or "Dynamic IP" button as desired to set up the system IP of LAN port.

Ethernet Connection Type	
Mode	<input checked="" type="radio"/> Static IP <input type="radio"/> Dynamic IP
Static IP	
IP Address	<input type="text" value="192.168.10.100"/>
IP Netmask	<input type="text" value="255.255.255.0"/>
IP Gateway	<input type="text" value="192.168.10.1"/>

- **Static IP:** The administrator can manually setup the LAN IP address when static IP is available/ preferred.
 - **IP Address :** The IP address of the LAN port; default IP address is 192.168.2.254
 - **IP Netmask :** The Subnet mask of the LAN port; default Netmask is 255.255.255.0
 - **IP Gateway :** The default gateway of the LAN port; default Gateway is 192.168.2.1
- **Dynamic IP:** This configuration type is applicable when the access point is connected to a network with the presence of a DHCP server; all related IP information will be provided by the DHCP server automatically.

Dynamic IP

Hostname	<input type="text"/>
----------	----------------------

- **Hostname :** The Hostname of the LAN port
- **DNS:** Check either "No Default DNS Server" or "Specify DNS Server IP" button as desired to set up the system DNS.

DNS	
DNS	<input checked="" type="radio"/> No Default DNS Server <input type="radio"/> Specify DNS Server IP
Primary DNS	<input type="text"/>
Secondary DNS	<input type="text"/>

- **Primary:** The IP address of the primary DNS server.
- **Secondary:** The IP address of the secondary DNS server.

• 802.1d Spanning Tree

802.1d Spanning Tree

Service Enable Disable

The spanning tree network protocol provides a loop free topology for a bridged LAN between LAN interface and 4 WDS interfaces from wds0 to wds3. The Spanning Tree Protocol, which is also referred to as STP, is defined in the IEEE Standard 802.1d. The Spanning tree always enabled on the access point. Below Figures depict a loop for a bridged LAN between LAN and WDS link

Click **Save** button to save your changes. Click **Reboot** button to activate your changes.

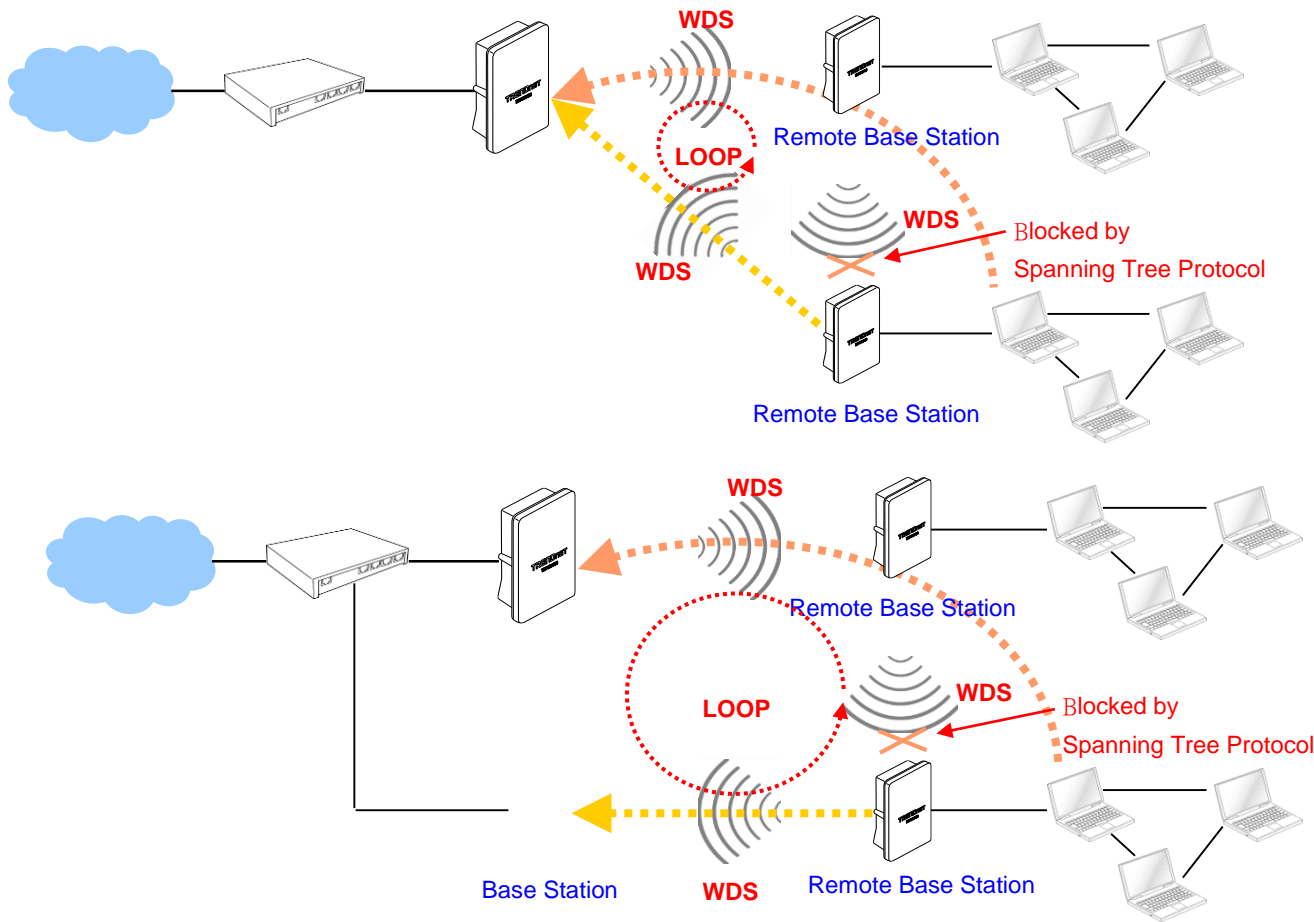

Wireless LAN Network

The network manager can configure related wireless settings, **General Settings**, **Advanced Settings**, **Virtual AP (VAP) Setting**, **Security Settings** and **MAC Filter Settings**.

Wireless General Setup

The administrator can change the data transmission, channel and output power settings for the system. Please click on **Wireless -> General Setup** and follow the below setting.

General Setup	
MAC Address	00:22:aa:00:11:08
Band Mode	802.11b/g/n
Channel	Auto <input type="button" value="Auto Scan"/>
Tx Power	Level 9
RF(ON/OFF) Schedule	Always Run

- **MAC Address:** The MAC address of the Wireless interface is displayed here.
- **Band Mode:** Select an appropriate wireless band; bands available are 801.11b, 802.11b/g, 802.11b/g/n or 802.11n only.
- **Channel:** Select the desired channel from the drop-down list to have the access point operate on. Click **Auto Scan** to scan for the best available channel to use based on the environment.
- **Tx Power:** You can adjust the output power of the system to get the appropriate coverage for your wireless network. Specify digit numbers between 1 to 100 (the unit is %) for your environment. If you are not sure which setting to choose, then keep the default setting, **100%**.
- **RF (ON/OFF) Schedule:** Select an assigned schedule of when to have the access point turn on. Select **Always Run** to have the access point always on.

When **Band Mode** select in **802.11a only mode**, the **HT(High Throughput)** settings should be hidden immediately.

HT Physical Mode	
TX/RX Stream	<input type="radio"/> 1 <input checked="" type="radio"/> 2
Channel BandWidth	<input type="radio"/> 20 <input checked="" type="radio"/> 20/40
Extension Channel	<input type="radio"/> Upper <input checked="" type="radio"/> Lower
MCS	Auto
Short GI	<input type="radio"/> Disable <input checked="" type="radio"/> Enable
Aggregation	<input type="radio"/> Disable <input checked="" type="radio"/> Enable
Aggregation Frames	32
Aggregation Size	50000

3

- **TxStream/Rx Stream:** Select the amount of transmit (TX) and Receive (RX) streams. By default, it's 2.
- **Channel Bandwidth:** The "20/40" MHz option is usually best. The other option is available for special circumstances.
- **Extensions Channel:** Select which section of channels to use for extension channels.
- **MCS:** This parameter represents transmission rate. By default (Auto) the fastest possible transmission rate will be selected. You have the option of selecting the speed if necessary. (Refer to **Appendix C. MCS Data Rate**)

Wireless Advanced Setup

To achieve optimal wireless performance, it is necessary to tweak advance setting per requirements properly, not necessary higher the better or lower. The administrator can change the RTS threshold and fragmentation threshold settings for the system. Please click on **Wireless -> Advanced Setup** and follow the below setting.

Advanced Setup	
Slot Time	9 <input type="text"/> Distance <input type="text"/>
ACK Timeout	64 <input type="text"/>
Beacon Interval	100 <input type="text"/>
DTIM Interval	1 <input type="text"/>
RTS Threshold	2346 <input type="text"/>
Short Preamble	<input checked="" type="radio"/> Enable <input type="radio"/> Disable
IGMP Snooping	<input type="radio"/> Enable <input checked="" type="radio"/> Disable
Greenfield	<input checked="" type="radio"/> Enable <input type="radio"/> Disable
WMM	<input checked="" type="radio"/> Enable <input type="radio"/> Disable

- **Short Slot:** By default, it's **"Enable"** for reducing the slot time from the standard **20 microseconds** to the **9 microsecond** short slot time. Slot time is the amount of time a device waits after a collision before retransmitting a packet. Reducing the slot time decreases the overall back-off, which increases throughput. Back-off, which is a multiple of the slot time, is the random length of time a station waits before sending a packet on the LAN. For a sender and receiver own right of the channel the shorter slot time help manage shorter wait time to re-transmit from collision because of hidden wireless clients or other causes. When collision sources can be removed sooner and other senders attempting to send are listening the channel (CSMA/CA) the owner of the channel should continue ownership and finish their transmission and release the channel. Then, following ownership of the channel will be sooner for the new pair due to shorter slot time. However, when long duration of existing collision sources and shorter slot time exist the owners might experience subsequent collisions. When adjustment to longer slot time can't improve performance then RTS/CTS could supplement and help improve performance.
- **ACK Timeout:** ACK timeout is in the range of **1~255** and set in unit of **microsecond**. The default value is **32** microsecond. All data transmission in 802.11b/g request an "Acknowledgement" (ACK) send by receiving radio. The transmitter will resend the original packet if correspondent ACK failed to arrive within specific time interval, also refer to as "ACK Timeout".
ACK Timeout is adjustable due to the fact that distance between two radio links may vary in different deployment. ACK Timeout makes significant influence in performance of long distance radio link. If ACK Timeout is set too short, transmitter

will start to "Resend" packet before ACK is received, and throughputs become low due to excessively high re-transmission. ACK Timeout is best determined by distance between the radios, data rate of average environment. The Timeout value is calculated based on round-trip time of packet with a little tolerance, So, if experiencing re-transmissions or poor performance the ACK Timeout could be made longer to accommodate.

- **Beacon Interval:** Beacon Interval is in the range of **20~1024** and set in unit of **millisecond**. The default value is **100** msec.

Access Point (AP) in IEEE 802.11 will send out a special approximated 50-byte frame, called "Beacon". Beacon is broadcast to all the stations, provides the basic information of AP such as SSID, channel, encryption keys, signal strength, time stamp, support data rate.

All the radio stations received beacon recognizes the existence of such AP, and may proceed next actions if the information from AP matches the requirement. Beacon is sent on a periodic basis, the time interval can be adjusted.

By increasing the beacon interval, you can reduce the number of beacons and associated overhead, but that will likely delay the association and roaming process because stations scanning for available access points may miss the beacons. You can decrease the beacon interval, which increases the rate of beacons. This will make the association and roaming process very responsive; however, the network will incur additional overhead and throughput will go down.

- **DTIM Interval:** The DTIM interval is in the range of **1~255**. The default is **1**.
DTIM is defined as *Delivery Traffic Indication Message*. It is used to notify the wireless stations, which support power saving mode, when to wake up to receive multicast frame. DTIM is necessary and critical in wireless environment as a mechanism to fulfill power-saving synchronization. A DTIM interval is a count of the number of beacon frames that must occur before the access point sends the buffered multicast frames. For instance, if DTIM Interval is set to 3, then the Wi-Fi clients will expect to receive a multicast frame after receiving three Beacon frame. The higher DTIM interval will help power saving and possibly decrease wireless throughput in multicast applications.
- **RTS Threshold:** TRTS Threshold is in the range of **1~2347** byte. The default is **2347** byte. The main purpose of enabling RTS by changing RTS threshold is to reduce possible collisions due to hidden wireless clients. RTS in AP will be enabled automatically if the packet size is larger than the Threshold value. By default, RTS is disabled in a normal environment supports non-jumbo frames.
- **Short Preamble:** By default, it's **"Enable"**. To **Disable** is to use Long 128-bit

Preamble Synchronization field. The preamble is used to signal "here is a train of data coming" to the receiver. The short preamble provides 72-bit Synchronization field to improve WLAN transmission efficiency with less overhead.

- **WMM:** By default, it's "Enabled".

Wireless WMM QoS Setup

To achieve optimal wireless performance, it is necessary to tweak advance setting per requirements properly, not necessary higher the better or lower.

The administrator can change the RTS threshold and fragmentation threshold settings for the system. Please click on **Wireless -> Advanced**

WMM QoS					
WMM Parameters of Access Point					
AC Type	CWmin	CWmax	AIFS	TxOp Limit	No ACK Policy bit
AC_BE(0)	4	6	3	0	<input type="checkbox"/>
AC_BK(1)	4	10	7	0	<input type="checkbox"/>
AC_VI(2)	3	4	1	3008	<input type="checkbox"/>
AC_VO(3)	2	3	1	1504	<input type="checkbox"/>
WMM Parameters of Station					
AC Type	CWmin	CWmax	AIFS	TxOp Limit	ACM bit
AC_BE(0)	4	10	3	0	<input type="checkbox"/>
AC_BK(1)	4	10	7	0	<input type="checkbox"/>
AC_VI(2)	3	4	2	3008	<input type="checkbox"/>
AC_VO(3)	2	3	2	1504	<input type="checkbox"/>

- **WMM Parameters of Access Point :** This affects traffic flowing from the access point to the client station

Queue	Data Transmitted AP to Clients	Priority	Description
AC_BK	Background.	Low	High throughput. Bulk data that requires maximum throughput and is not time-sensitive is sent to this queue (FTP data, for example).

AC_BE	Best Effort	Medium	Medium throughput and delay. Most traditional IP data is sent to this queue
AC_VI	Video	High	Minimum delay. Time-sensitive video data is automatically sent to this queue
AC_VO	Voice	High	Time-sensitive data like VoIP and streaming media are automatically sent to this queue

Configuring QoS options consists of setting parameters on existing queues for different types of wireless traffic. You can configure different minimum and maximum wait times for the transmission of packets in each queue based on the requirements of the media being sent. Queues automatically provide minimum transmission delay for Voice, Video, multimedia, and mission critical applications, and rely on best-effort parameters for traditional IP data.

As an Example, time-sensitive Voice & Video, and multimedia are given effectively higher priority for transmission (lower wait times for channel access), while other applications and traditional IP data which are less time-sensitive but often more data-intensive are expected to tolerate longer wait times.

- **Aifsn:** The Arbitration Inter-Frame Spacing Number specifies a wait time (in milliseconds) for data frames
- **CWmin:** Minimum Contention Window. This parameter is input to the algorithm that determines the initial random back-off wait time ("window") for retry of a transmission. The value specified here in the Minimum Contention Window is the upper limit (in milliseconds) of a range from which the initial random back-off wait time is determined.
- **CWmax:** Maximum Contention Window. The value specified here in the Maximum Contention Window is the upper limit (in milliseconds) for the doubling of the random back-off value. This doubling continues until either the data frame is sent or the Maximum Contention Window size is reached. Once the Maximum Contention Window size is reached, retries will continue until a maximum number of retries allowed is reached. Valid values for the "cwmax" are 1, 3, 7, 15, 31, 63, 127, 255, 511, or 1024. The value for "cwmax" must be higher than the value for "cwmin".
- **Txop:** Transmission Opportunity is an interval of time when a WME AP has the right to initiate transmissions onto the wireless medium (WM). This value specifies (in milliseconds) the Transmission Opportunity (TXOP) for AP; that is, the interval of time when the WMM AP has the right to initiate transmissions on the wireless network.

- **ACM:** Admission Control Mandatory, ACM only takes effect on AC_VI and AC_VO. When you do not click Checkbox, it means that the ACM is controlled by the connecting AP. If you click Checkbox, it means that the Client is in charge.
- **AckPolicy:** Acknowledgment Policy, WMM defines two ACK policies: **Normal ACK** and **No ACK**. Click "**Checkbox**" indicates "**No ACK**"

Queue	Data Transmitted Clients to AP	Priority	Description
AC_BK	Background.	Low	High throughput. Bulk data that requires maximum throughput and is not time-sensitive is sent to this queue (FTP data, for example).
AC_BE	Best Effort	Medium	Medium throughput and delay. Most traditional IP data is sent to this queue
AC_VI	Video	High	Minimum delay. Time-sensitive video data is automatically sent to this queue
AC_VO	Voice	High	Time-sensitive data like VoIP and streaming media are automatically sent to this queue

When the no acknowledgment (No ACK) policy is used, the recipient does not acknowledge received packets during wireless packet exchange. This policy is suitable in the environment where communication quality is fine and interference is weak. While the No ACK policy helps improve transmission efficiency, it can cause increased packet loss when communication quality deteriorates. This is because when this policy is used, a sender does not retransmit packets that have not been received by the recipient. When the Normal ACK policy is used, the recipient acknowledges each received unicast packet.

- **WMM Parameters of Station:** *This affects traffic flowing from the client station to the access point.*
- **Aifsn:** The Arbitration Inter-Frame Spacing Number specifies a wait time (in milliseconds) for data frames

- **CWmin:** Minimum Contention Window. This parameter is input to the algorithm that determines the initial random backoff wait time ("window") for retry of a transmission. The value specified here in the Minimum Contention Window is the upper limit (in milliseconds) of a range from which the initial random backoff wait time is determined.
- **CWmax:** Maximum Contention Window. The value specified here in the Maximum Contention Window is the upper limit (in milliseconds) for the doubling of the random backoff value. This doubling continues until either the data frame is sent or the Maximum Contention Window size is reached. Once the Maximum Contention Window size is reached, retries will continue until a maximum number of retries allowed is reached. Valid values for the "cwmax" are 1, 3, 7, 15, 31, 63, 127, 255, 511, or 1024. The value for "cwmax" must be higher than the value for "cwmin".
- **Txop:** Transmission Opportunity is an interval of time when a WME AP has the right to initiate transmissions onto the wireless medium (WM). This value specifies (in milliseconds) the Transmission Opportunity (Txop) for AP; that is, the interval of time when the WMM AP has the right to initiate transmissions on the wireless network.
- **ACM:** Admission Control Mandatory, ACM only takes effect on AC_VI and AC_VO. When you do not click Checkbox, it means that the ACM is controlled by the connecting AP. If you click Checkbox, it means that the Client is in charge. Click **Save** button to save your changes. Click **Reboot** button to activate your changes. The items in this page are for AP's RF advanced settings and will be applied to **all VAPs** and **WDS Links**.

Create Virtual AP (VAP)

The access point supports broadcasting multiple SSIDs, allowing the creation of Virtual Access Points, partitioning a single physical access point into 7 logical access points, each of which can have a different set of security, VLAN Tag(ID) and network settings.

Figure 3-2 shows multiple SSIDs with different security type and VLAN settings.

Multiple SSIDs with different Security Type and VLAN Tag

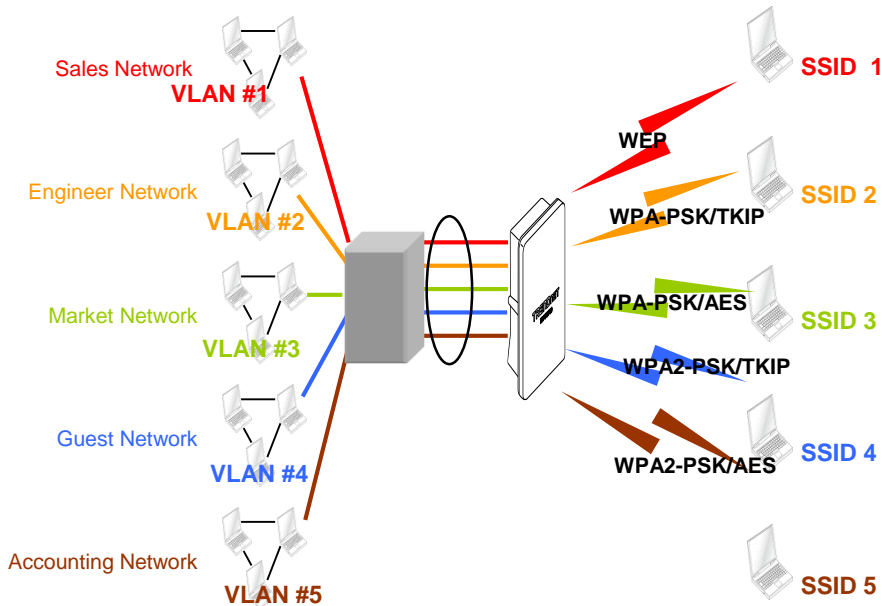

Virtual AP Overview

The administrator can view all of the Virtual AP's settings via this page.

Please click on **Wireless -> Virtual AP Setup** and the Virtual AP Overview Page appears.

VAP	MAC Address	ESSID	Status	Security Type	MAC Filter Edit	MAC Filter Status	VAP Edit
VAP0	00:22:AA:00:11:08	TRENDnet7380_2.4GHz	On	Disabled	Edit	Disable	Edit
VAP1		TRENDnet7381_2.4GHz	Off	Disabled	Edit	Disable	Edit
VAP2		TRENDnet7382_2.4GHz	Off	Disabled	Edit	Disable	Edit
VAP3		TRENDnet7383_2.4GHz	Off	Disabled	Edit	Disable	Edit
VAP4		TRENDnet7384_2.4GHz	Off	Disabled	Edit	Disable	Edit
VAP5		TRENDnet7385_2.4GHz	Off	Disabled	Edit	Disable	Edit
VAP6		TRENDnet7386_2.4GHz	Off	Disabled	Edit	Disable	Edit
VAP7		TRENDnet7387_2.4GHz	Off	Disabled	Edit	Disable	Edit

- **VAP:** Indicate the system's Virtual AP.
- **MAC Address:** The MAC address of the VAP Interface is displayed here. When you enable AP and reboot system, the MAC address will display here.
- **ESSID:** Indicate the ESSID of the respective Virtual AP
- **Status:** Indicate the Status of the respective Virtual AP. The **Primary AP** always on.
- **Security Type:** Indicate a used security type of the respective Virtual AP.
- **MAC Filter:** Indicate a used MAC filter of the respective Virtual AP.
- **Edit:** Click **Edit** button to configure Virtual AP's settings, including security type and MAC Filter.

Virtual AP Setup

For each Virtual AP, administrators can configure SSID, VLAN tag(ID), SSID broadcasting, Maximum number of client associations, security type settings.

Click **Edit** button on the Edit column, and then a Virtual AP setup page appears.

Security	
ESSID	TRENDnet7380_2.4GHz
Hidden SSID	<input checked="" type="radio"/> Enable <input type="radio"/> Disable
Client Isolation	<input checked="" type="radio"/> Enable <input type="radio"/> Disable
IAPP	<input checked="" type="radio"/> Enable <input type="radio"/> Disable
Maximum Clients	32
VLAN ID(Tag)	LAN <input type="checkbox"/> VLAN ID <input type="text"/>
Security Type	Disable

- **ESSID:** Extended Service Set ID, when clients are browsing for available wireless networks, this is the SSID that will appear in the list. ESSID will determine the service type available to AP's clients associated with the specified VAP.
- **Hidden SSID:** By default, it's "**Disable**". Enable this option to stop the SSID broadcast in your network. When disabled, people could easily obtain the SSID information with the site survey software and get access to the network if security is not turned on. When enabled, network security is enhanced. It's suggested to enable it after AP security settings are archived and setting of AP clients could make to associate to it.
- **Client Isolation:** Select **Enable**, all clients will be isolated from each other, that mean all clients cannot reach to other clients. Below Figures depict Client Isolation and AP Isolation
- **IAPP:**
- **Maximum Clients:** The default value is **32**. You can enter the number of wireless clients that can associate to a particular SSID. When the number of client is set to 5, only 5 clients at most are allowed to connect to this VAP.
- **VLAN Tag (ID) :** By default, it's selected "**Disable**".

This system supports tagged Virtual LAN (VLAN). A valid number of **1** to **4094** can be entered after it's enabled. If your network utilize VLANs you could tie a VLAN Tag to a specific SSID, and packets from/to wireless clients belonging to that SSID will be tagged with that VLAN Tag. This enables security of wireless applications by applying VLAN Tag.

- **Security Type:** Select the desired security type from the drop-down list; the options

are **Disable**, **WEP**, **WPA-PSK**, **WPA2-PSK**, **WPA-Enterprise**, **WPA2-Enterprise** and **WEP 802.1X**.

- **Disable:** Data are unencrypted during transmission when this option is selected.

WEP	
Key Length	64 bits
WEP Auth Method	<input checked="" type="checkbox"/> Open System <input type="checkbox"/> Shared
Key Index	1
WEP Key 1	<input type="text"/>
WEP Key 2	<input type="text"/>
WEP Key 3	<input type="text"/>
WEP Key 4	<input type="text"/>

- **WEP Auth Method:** Enable the desire option among **OPEN** or **SHARED**
 - **Key Index:** Key index is used to designate the WEP key during data transmission. 4 different WEP keys can be entered at the same time, but only one is chosen.
 - **WEP Key #:** Enter **HEX** or **ASCII** format WEP key value; the system supports up to 4 sets of WEP keys.
- **WPA-PSK (or WPA2-PSK) :** WPA (or WPA2) Algorithms, allows the system accessing the network by using the WPA-PSK protected access.

WPA General	
Cipher Suite	<input type="radio"/> AES <input checked="" type="radio"/> TKIP
Group Key Update Period	600
Master Key Update Period	83400
Key Type	<input checked="" type="radio"/> ASCII <input type="radio"/> HEX
Pre-shared Key	<input type="text"/>

- **Cipher Suite:** By default, it is **AES**. Select either AES or TKIP cipher suites
- **Group Key Update Period:** By default, it is **600** seconds. This time interval for rekeying GTK, broadcast/multicast encryption keys, in seconds. Entering the time-length is required.

- **Master Key Update Period:** By default, it is **83499** seconds. This time interval for rekeying GTK, broadcast/multicast encryption keys, in seconds. Entering the time-length is required.
 - **Pre-shared Key:** Enter the pre-shared key; the format shall go with the selected key type.
- **WPA-Enterprise (or WPA2-Enterprise):** The RADIUS authentication and encryption will be both enabled if this is selected.

WPA General	
Cipher Suite	<input checked="" type="radio"/> AES <input type="radio"/> TKIP
Group Key Update Period	<input type="text" value="600"/>
Master Key Update Period	<input type="text" value="83400"/>
EAP Reauth Period	<input type="text" value="3600"/>
Authentication RADIUS Server	
Server IP	<input type="text"/>
Port	<input type="text" value="1812"/>
Shared Secret	<input type="text"/>
Accounting RADIUS Server	<input checked="" type="radio"/> Enable <input type="radio"/> Disable

- **WPA General Settings:**
 - **Cipher Suite:** By default, it is AES. Select either AES or TKIP cipher suites
 - **Group Key Update Period:** By default, it's **3600** seconds. This time interval for rekeying GTK, broadcast/multicast encryption keys, in seconds. Entering the time-length is required.
 - **Master Key Update Period:** By default, it is **83499** seconds. This time interval for rekeying GTK, broadcast/multicast encryption keys, in seconds. Entering the time-length is required.
 - **EAP Reauth Period:** By default, it's **3600** seconds. Set **WPA2** PMKID cache timeout period, after time out, the cached key will be deleted.
 - **Pre-Authentication:** By default, it's "Disable". To Enable is use to speed up roaming before pre-authenticating IEEE 802.1X/EAP part of the full RSN authentication and key handshake before actually associating with a new AP.

- **Radius Server Settings :**
 - **IP Address:** Enter the IP address of the Authentication RADIUS server.
 - **Port:** By default, it's 1812. The port number used to communicate with RADIUS server.
 - **Shared secret:** A secret key used between system and RADIUS server. Supports 8 to 64 characters.
 - **Accounting RADIUS Server:** Enable to set Account RADIUS server.
- **WEP 802.1X:** When WEP 802.1x Authentication is enabled, please refer to the following Dynamic WEP and RADIUS settings to complete configuration.

Dynamic WEP Setting	
WEP Key Length	<input type="radio"/> 64bits <input checked="" type="radio"/> 128bits
WEP Key Update Period	<input type="text" value="300"/>
EAP Reauth Period	<input type="text" value="3600"/>
Authentication RADIUS Server	
Server IP	<input type="text"/>
Port	<input type="text" value="1812"/>
Shared Secret	<input type="text"/>
Accounting RADIUS Server	<input checked="" type="radio"/> Enable <input type="radio"/> Disable

- **Radius Server Settings:**
 - **IP Address:** Enter the IP address of the Authentication RADIUS server.
 - **Port:** By default, it's **1812**. The port number used to communicate with RADIUS server.
 - **Shared secret:** A secret key used between system and RADIUS server. Supports **8** to **64** characters.
 - **Accounting RADIUS Server:** Enable to set Account RADIUS server.

Click **Save** button to save your changes. Click **Reboot** button to activate your changes

Wireless MAC Filter Setup

Continue **Virtual AP Setup** section. For each Virtual AP setting, the administrator can allow or reject clients to access each Virtual AP.

MAC Rules	
Action	Only Deny List MAC <input type="button" value="Save"/>
ACL MAC Address	
MAC Address	<input type="text"/> <input type="button" value="Add"/>

- **MAC Filter Setup:** By default, it's **"Disable"**. Options are **Disable, Only Deny List MAC or Only Allow List MAC**.
Two ways to set MAC filter rules:
 - **Only Allow List MAC:** The wireless clients in the **"Enable"** list will be **allowed** to access the Access Point; All others or clients in the **"Disable"** list will be **denied**.
 - **Only Deny List MAC:** The wireless clients in the **"Enable"** list will be **denied** to access the Access Point; All others or clients in the **"Disable"** list will be **allowed**.

Add a station MAC: Enter MAC address (e.g. aa:bb:cc:00:00:0a) and click **"Add"** button, then the MAC address should display in the **"Enable"** List.

There are a maximum of **20** clients allowed in this **"Enable"** List. The MAC addresses of the wireless clients can be added and removed to the list using the **Add** and **Remove** buttons. Click **Reboot** button to activate your changes

Wireless Network Expansion

The administrator could create WDS Links to expand wireless network. When WDS is enabled, access point functions as a wireless bridge and is able to communicate with other access points via WDS links. **A WDS link is bidirectional and both side must support WDS. Access points know each other by MAC Address. In other words, each access point needs to include MAC address of its peer. Ensure all access points are configured with the same channel and own same security type settings.**

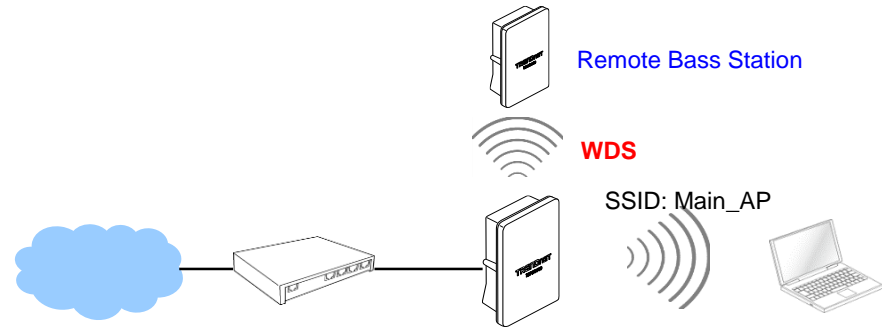

Please click on **Wireless -> WDS Setup** and follow the below setting.

WDS Setup			
The Channel must be fixed!			
Service	<input checked="" type="radio"/> Enable <input type="radio"/> Disable		
#	Enable	WDS Peer's MAC Address	Description
1	<input type="checkbox"/>	<input type="text"/>	<input type="text"/>
2	<input type="checkbox"/>	<input type="text"/>	<input type="text"/>
3	<input type="checkbox"/>	<input type="text"/>	<input type="text"/>
4	<input type="checkbox"/>	<input type="text"/>	<input type="text"/>

- **Security Type:** Option is **"Disable"**, **"WEP"**, **"TKIP"** or **"AES"** from drop-down list. Needs the same type to build WDS links. Security type takes effect when WDS is

enabled.

- **WEP Key:** Enter **5 / 13 ASCII** or **10 / 26 HEX** format WEP key.
- **TKIP Key:** Enter **8 to 63 ASCII** or **64 HEX** format TKIP key.
- **AES Key:** Enter **8 to 63 ASCII** or **64 HEX** format AES key.

- **WDS MAC List**

- **Enable:** Click **Enable** to create WDS link.
- **WDS Peer's MAC Address:** Enter the MAC address of WDS peer.
- **Description:** Description of WDS link.

Click **Save** button to save your changes. Click **Reboot** button to activate your changes

System Status

This section breaks down into subsections of **System Overview**, **Associated Clients Status**, **WDS Link Status**, **Extra Information** and **Event Log**.

System Overview

Display detailed information of **System**, **Network**, **LAN and Wireless** in the System Overview page.

- **Device Information:** Display the information of the system.

Device Information	
Mode	AP
Host Name	TEW-738APBO
Host Description	10dBi Outdoor PoE Access Point
Firmware Version	V1.0.19
Firmware Date	2014/04/23 09:44:51
Country	US
System Time	2013/07/09 00:35:09
System Up Time	8 Day 00:35:27
ETH1 MAC	00:22:AA:00:11:07
ETH2 MAC	00:22:AA:00:11:06
Wireless MAC	00:22:AA:00:11:08
CPU Loading	0%
Memory Used	71%

- **Operating Mode:** The mode currently in service.
- **Host Name:** The name of the system.

- **Host Description:** A description of the system.
- **Firmware Version:** The current installed firmware version.
- **Firmware Date:** The build time of installed firmware.
- **Device Time:** The current time of the system.
- **System Up Time:** The time period that system has been in service since last reboot.
- **ETH1/ETH2MAC:** Ethernet MAC address of the access point.
- **Wireless MAC:** Wireless MAC address of the access point
- **CPU Loading:** The CPU loading of the access point
- **Memory Used:** Memory usage of the access point.

- **LAN Information:** Display total received and transmitted statistics on the LAN interface.

LAN Information	
Ethernet Connection Type	Static IP
IP Address	192.168.10.100
IP Netmask	255.255.255.0
IP Gateway	192.168.10.1
DNS	

- **Ethernet Connection Type:** The connection applied on the access point.
- **IP Address:** The management IP of system. By default, it's 192.168.2.254.
- **IP Netmask:** The network mask. By default, it's 255.255.255.0.
- **IP Gateway:** The gateway IP addresses and by default, it's 192.168.2.1.
- **Primary DNS:** The primary DNS server in service.

- **Wireless Information:** Display total received and transmitted statistics on available Virtual AP.

Wireless Information	
WiFi	On
Band	802.11b/g/n
Channel	5
Current Txpower	28 dBm (630 mW)
Data Rate	Auto (300Mb/s)

- **WiFi:** Wireless status of the access point.
- **Band:** Operating wireless band of the access point.
- **Channel:** Operating channel of the access point.
- **Current Tx Power:** Transmit power of the access point.
- **Data Rate:** Current wireless data rate of the access point.

Associated Clients Status

It displays ESSID, on/off Status, Security Type, total number of wireless clients associated with all Virtual AP.

VAP	ESSID	Status	Security Type	Clients
VAP0	TRENDnet7380_2.4GHz	On	Disabled	2
VAP1	TRENDnet7381_2.4GHz	Off	Disabled	0
VAP2	TRENDnet7382_2.4GHz	Off	Disabled	0
VAP3	TRENDnet7383_2.4GHz	Off	Disabled	0
VAP4	TRENDnet7384_2.4GHz	Off	Disabled	0
VAP5	TRENDnet7385_2.4GHz	Off	Disabled	0
VAP6	TRENDnet7386_2.4GHz	Off	Disabled	0
VAP7	TRENDnet7387_2.4GHz	Off	Disabled	0

- **VAP Information:** Highlights key VAP information.
 - **VAP:** Available VAP from Primary AP to VAP6.
 - **ESSID:** Display name of ESSID for each VAP.
 - **Status :** On/Off
 - **Security Type:** Display chosen security type; WEP, WPA/WPA2-PSK, WPA/WPA2-

Enterprise.

- **Clients:** Display total number of wireless connections for each VAP.

- **VAP Clients:** Display all associated clients on each Virtual AP.

#	MAC Address	RSSI	TX/RX Rate	TX/RX SEQ	TX/RX Bytes	Connect Time	Actions
1	00:14:d1:c2:da:84	46	0 / 1	0 / 49872	0 / 1.0 M	1 Day 19:40:10	Disconnect
2	3c:ab:8e:51:ad:b5	10	0 / 1	0 / 1136	0 / 150.9 K	03:02:43	Disconnect

- **MAC Address:** MAC address of associated clients
- **RSSI:** Signal Strength of from associated clients.
- **TX/RX Rate:** Transmit and receive connection rate
- **TX/RX SEQ:** Transmit and receive sequence.
- **TX/RX Bytes:** Transmit and receive bytes
- **Connect Time:** Connection time
- **Disconnect:** Click “Disconnect” button to manually disconnect a wireless client in a Virtual AP.

Show WDS Link Status

Peers MAC Address, antenna 0/1 received signal strength, phy mode and channel bandwidth for each WDS are available.

#	MAC Address	RSSI	TX/RX Rate	TX/RX SEQ	TX/RX Bytes
No WDS Link!					

- **MAC Address:** Display MAC address of WDS peer.
- **RSSI:** Indicate the signal strength of the respective WDS links.
- **TX/RX SEQ:** Transmit and receive sequence.
- **TX/RX Bytes:** Transmit and receive bytes

Extra Information

Users could pull out information such as Route table, ARP table, MAC table, Bridge table or STP available in the drop-down list from system. The “Refresh” button is used to retrieve latest table information.

Extra Information			
Information	Route Information		
Route Information			
Destination	Gateway	Netmask	Interface
192.168.10.0	0.0.0.0	255.255.255.0	bre0
239.0.0.0	0.0.0.0	255.0.0.0	bre0
224.0.0.0	0.0.0.0	224.0.0.0	bre0
0.0.0.0	192.168.10.1	0.0.0.0	bre0

- **Route table information:** Select “Route table information” on the drop-down list to display route table. The access point could be used as a L2 or L3 device. It doesn't support dynamic routing protocols such as RIP or OSPF. Static routes to specific hosts, networks or default gateway are set up automatically according to the IP configuration of system's interfaces. When used as a L2 device, it could switch packets and, as L3 device, it's capable of being a gateway to route packets inward and outward.

Route Information			
Destination	Gateway	Netmask	Interface
192.168.10.0	0.0.0.0	255.255.255.0	bre0
239.0.0.0	0.0.0.0	255.0.0.0	bre0
224.0.0.0	0.0.0.0	224.0.0.0	bre0
0.0.0.0	192.168.10.1	0.0.0.0	bre0

- **ARP table Information:** Select “ARP Table Information” on the drop-down list to display ARP table. ARP associates each IP address to a unique hardware address (MAC) of a device. It is important to have a unique IP address as final destination to switch packets to.

ARP Table Information		
IP Address	MAC Address	Interface
192.168.10.123	00:26:2d:5b:46:53	bre0

- **Bridge table information:** Select “Bridge Table information” on the drop-down list to display bridge table. Bridge table will show Bridge ID and STP's Status on the each Ethernet bridge and its attached interfaces, the Bridge Port should be attached to some interfaces (e.g. eth2, ra0~ra6 and wds0~wds3).

Bridge Table Information			
Bridge Port	Bridge ID	STP Enabled	Interface
LAN	8000.0022aa001106	no	eth1
			eth0
			ath0

- **Bridge MAC information:** Select “Bridge MACs Information” on the drop-down list to display MAC table.

Bridge MACs Table Information			
Port	MAC Address	Local	Ageing Timer
VAP0	00:14:d1:c2:da:84	no	3.17
LAN	00:22:aa:00:11:06	yes	0.00
WAN	00:22:aa:00:11:07	yes	0.00
VAP0	00:22:aa:00:11:08	yes	0.00
WAN	00:26:2d:5b:46:53	no	0.04

This table displays local MAC addresses associated with wired or wireless interfaces, but also remember non-local MAC addresses learned from wired or wireless interfaces. Ageing timers will be reset when existing MAC addresses in table are learned again or added when new MAC addresses are seen from wired or wireless interfaces as well. When time runs out for a particular entry, it will be pruned from the table. In that situation, switching packet to that particular MAC address will be dropped.

Event Log

The Event log displays system events when system is up and running. Also, it becomes very useful as a troubleshooting tool when issues are experienced in system.

Time	Facility	Severity	Message
2013-07-06 03:32:47	System	Info	Authentication successful for admin from 192.168.10.123

- **Time:** The date and time when the event occurred.
- **Facility:** It helps users to identify source of events such "System" or "User"
- **Severity:** Severity level that a specific event is associated such as "info", "error", "warning", etc.
- **Message:** Description of the event.

Click **Refresh** button to renew the log, or click **Clear** button to clear all the record.

WDS Mode Configuration

Please refer to illustrations of the section 1.3 for possible applications in the WDS mode. This section provides detailed explanation for users to configure in the WDS mode with help of illustrations. In the WDS mode, functions listed in the table below are also available from the Web-based GUI interface.

External Network Connection

Network Requirement

You could expand your Ethernet network via WDS link. In this mode, the access point connects directly to a wired LAN, and wirelessly bridges to a remote access point via a WDS link as shown in Figure 4-1. In the mode, it can't associate with any wireless clients.

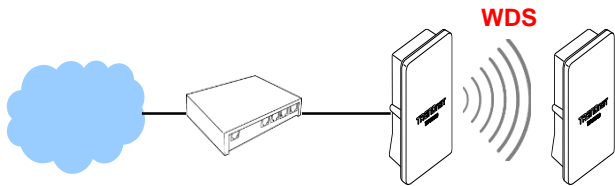

Point to Point network Configuration

Configure LAN IP

Here are the instructions to setup the local IP Address and Netmask. Please click on **System** -> **LAN** and follow the below setting.

- **Mode:** Check either "Static IP" or "Dynamic IP" button as desired to set up the system IP of LAN port.

Ethernet Connection Type	
Mode	<input checked="" type="radio"/> Static IP <input type="radio"/> Dynamic IP
Static IP	
IP Address	192.168.10.100
IP Netmask	255.255.255.0
IP Gateway	192.168.10.1

Option	System	Wireless	Utilities	Status
Functions	Operating	General Setup	Profiles Settings	System
	LAN	Advanced Setup	Firmware	WDS Status
	Management	WDS Setup	Network Utility	Extra Info
	Time Server		Reboot	Event Log
	SNMP			

- **Static IP :** The administrator can manually setup the LAN IP address when static IP is available/ preferred.
 - **IP Address :** The IP address of the LAN port; default IP address is 192.168.2.254
 - **IP Netmask :** The Subnet mask of the LAN port; default Netmask is 255.255.255.0
 - **IP Gateway :** The default gateway of the LAN port; default Gateway is 192.168.2.1
- **Dynamic IP :** This configuration type is applicable when the access point is connected to a network with the presence of a DHCP server; all related IP information will be provided by the DHCP server automatically.

Dynamic IP	
Hostname	<input type="text"/>

- **Hostname :** The Hostname of the LAN port
- **DNS :** Check either "No Default DNS Server" or "Specify DNS Server IP" button as desired to set up the system DNS.

DNS	
DNS	<input checked="" type="radio"/> No Default DNS Server <input type="radio"/> Specify DNS Server IP
Primary DNS	<input type="text"/>
Secondary DNS	<input type="text"/>

- **Primary:** The IP address of the primary DNS server.
- **Secondary:** The IP address of the secondary DNS server.

● **802.1d Spanning Tree**

802.1d Spanning Tree	
Service	<input type="radio"/> Enable <input checked="" type="radio"/> Disable

The spanning tree network protocol provides a loop free topology for a bridged LAN between LAN interface and 4 WDS interfaces from wds0 to wds3. The Spanning Tree Protocol, which is also referred to as STP, is defined in the IEEE Standard 802.1d. The Spanning tree always enabled on the access point. Below Figures depict a loop for a bridged LAN between LAN and WDS link

Click **Save** button to save your changes. Click **Reboot** button to activate your changes

Wireless Network Expansion

The network manager can configure related wireless settings, **General Settings**, **Advanced Settings** and **WDS Settings**.

Wireless General Setup

The administrator can change the data transmission, channel and output power settings for the system. Please click on **Wireless -> General Setup** and follow the below setting.

General Setup	
MAC Address	00:22:aa:00:11:08
Band Mode	802.11b/g/n
Channel	Auto <input type="button" value="Auto Scan"/>
Tx Power	Level 9
RF(ON/OFF) Schedule	Always Run

- **MAC Address:** The MAC address of the Wireless interface is displayed here.
- **Band Mode:** Select an appropriate wireless band; bands available are 801.11b, 802.11b/g, 802.11b/g/n or 802.11n only.
- **Channel:** Select the desired channel from the drop-down list to have the access point operate on. Click **Auto Scan** to scan for the best available channel to use based on the environment.
- **Tx Power:** You can adjust the output power of the system to get the appropriate coverage for your wireless network. Specify digit numbers between 1 to 100 (the unit is %) for your environment. If you are not sure which setting to choose, then keep the default setting, **100%**.
- **RF (ON/OFF) Schedule:** Select an assigned schedule of when to have the access point turn on. Select **Always Run** to have the access point always on.

When **Band Mode** select in **802.11a only mode**, the **HT(High Throughput)** settings should be hidden immediately.

HT Physical Mode	
TX/RX Stream	<input type="radio"/> 1 <input checked="" type="radio"/> 2
Channel BandWidth	<input type="radio"/> 20 <input checked="" type="radio"/> 20/40
Extension Channel	<input type="radio"/> Upper <input checked="" type="radio"/> Lower
MCS	Auto
Short GI	<input type="radio"/> Disable <input checked="" type="radio"/> Enable
Aggregation	<input type="radio"/> Disable <input checked="" type="radio"/> Enable
Aggregation Frames	32
Aggregation Size	50000

- **TxStream/Rx Stream:** Select the amount of transmit (TX) and Receive (RX) streams.

By default, it's 2.

- **Channel Bandwidth:** The "20/40" MHz option is usually best. The other option is available for special circumstances.
- **Extensions Channel:** Select which section of channels to use for extension channels.
- **MCS:** This parameter represents transmission rate. By default (Auto) the fastest possible transmission rate will be selected. You have the option of selecting the speed if necessary. (Refer to **Appendix C. MCS Data Rate**)

Wireless Advanced Setup

To achieve optimal wireless performance, it is necessary to tweak advance setting per requirements properly, not necessary higher the better or lower. The administrator can change the RTS threshold and fragmentation threshold settings for the system. Please click on **Wireless -> Advanced Setup** and follow the below setting.

Advanced Setup	
Slot Time	9 <input type="button" value="Distance"/>
ACK Timeout	64
Beacon Interval	100
DTIM Interval	1
RTS Threshold	2346
Short Preamble	<input checked="" type="radio"/> Enable <input type="radio"/> Disable
IGMP Snooping	<input type="radio"/> Enable <input checked="" type="radio"/> Disable
Greenfield	<input checked="" type="radio"/> Enable <input type="radio"/> Disable
WMM	<input checked="" type="radio"/> Enable <input type="radio"/> Disable

- **Short Slot:** By default, it's "Enable" for reducing the slot time from the standard 20 microseconds to the 9 microsecond short slot time. Slot time is the amount of time a device waits after a collision before retransmitting a packet. Reducing the slot time decreases the overall back-off, which increases throughput. Back-off, which is a multiple of the slot time, is the random length of time a station waits before sending a packet on the LAN. For a sender and receiver own right of the channel the shorter slot time help manage shorter wait time to re-transmit from collision

because of hidden wireless clients or other causes. When collision sources can be removed sooner and other senders attempting to send are listening the channel (CSMA/CA) the owner of the channel should continue ownership and finish their transmission and release the channel. Then, following ownership of the channel will be sooner for the new pair due to shorter slot time. However, when long duration of existing collision sources and shorter slot time exist the owners might experience subsequent collisions. When adjustment to longer slot time can't improve performance then RTS/CTS could supplement and help improve performance.

- **ACK Timeout:** ACK timeout is in the range of 1~255 and set in unit of *microsecond*. The default value is 32 microsecond. All data transmission in 802.11b/g request an "Acknowledgement" (ACK) send by receiving radio. The transmitter will resend the original packet if correspondent ACK failed to arrive within specific time interval, also refer to as "ACK Timeout".

ACK Timeout is adjustable due to the fact that distance between two radio links may vary in different deployment. ACK Timeout makes significant influence in performance of long distance radio link. If ACK Timeout is set too short, transmitter will start to "Resend" packet before ACK is received, and throughputs become low due to excessively high re-transmission. ACK Timeout is best determined by distance between the radios, data rate of average environment. The Timeout value is calculated based on round-trip time of packet with a little tolerance, So, if experiencing re-transmissions or poor performance the ACK Timeout could be made longer to accommodate.

- **Beacon Interval::** Beacon Interval is in the range of 20~1024 and set in unit of *millisecond*. The default value is 100 msec.

Access Point (AP) in IEEE 802.11 will send out a special approximated 50-byte frame, called "Beacon". Beacon is broadcast to all the stations, provides the basic information of AP such as SSID, channel, encryption keys, signal strength, time stamp, support data rate.

All the radio stations received beacon recognizes the existence of such AP, and may proceed next actions if the information from AP matches the requirement. Beacon is sent on a periodic basis, the time interval can be adjusted.

By increasing the beacon interval, you can reduce the number of beacons and associated overhead, but that will likely delay the association and roaming process because stations scanning for available access points may miss the beacons. You can decrease the beacon interval, which increases the rate of beacons. This will make the association and roaming process very responsive; however, the network will incur additional overhead and throughput will go down.

- DTIM Interval:** The DTIM interval is in the range of 1~255. The default is 1.
 DTIM is defined as *Delivery Traffic Indication Message*. It is used to notify the wireless stations, which support power saving mode, when to wake up to receive multicast frame. DTIM is necessary and critical in wireless environment as a mechanism to fulfill power-saving synchronization. A DTIM interval is a count of the number of beacon frames that must occur before the access point sends the buffered multicast frames. For instance, if DTIM Interval is set to 3, then the Wi-Fi clients will expect to receive a multicast frame after receiving three Beacon frame. The higher DTIM interval will help power saving and possibly decrease wireless throughput in multicast applications.
- RTS Threshold:** TRTS Threshold is in the range of 1~2347 byte. The default is 2347 byte. The main purpose of enabling RTS by changing RTS threshold is to reduce possible collisions due to hidden wireless clients. RTS in AP will be enabled automatically if the packet size is larger than the Threshold value. By default, RTS is disabled in a normal environment supports non-jumbo frames.
- Short Preamble:** By default, it's "Enable". To *Disable* is to use Long 128-bit Preamble Synchronization field. The preamble is used to signal "here is a train of data coming" to the receiver. The short preamble provides 72-bit Synchronization field to improve WLAN transmission efficiency with less overhead.
- WMM:** By default, it's "Enabled".

Wireless WMM QoS Setup

To achieve optimal wireless performance, it is necessary to tweak advance setting per requirements properly, not necessary higher the better or lower. The administrator can change the RTS threshold and fragmentation threshold settings for the system. Please click on **Wireless -> Advanced**

WMM QoS					
WMM Parameters of Access Point					
AC Type	CWmin	CWmax	AIFS	TxOp Limit	No ACK Policy bit
AC_BE(0)	4	6	3	0	<input type="checkbox"/>
AC_BK(1)	4	10	7	0	<input type="checkbox"/>
AC_VI(2)	3	4	1	3008	<input type="checkbox"/>
AC_VO(3)	2	3	1	1504	<input type="checkbox"/>

WMM Parameters of Station					
AC Type	CWmin	CWmax	AIFS	TxOp Limit	ACM bit
AC_BE(0)	4	10	3	0	<input type="checkbox"/>
AC_BK(1)	4	10	7	0	<input type="checkbox"/>
AC_VI(2)	3	4	2	3008	<input type="checkbox"/>
AC_VO(3)	2	3	2	1504	<input type="checkbox"/>

- WMM Parameters of Access Point :** *This affects traffic flowing from the access point to the client station*

Queue	Data Transmitted AP to Clients	Priority	Description
AC_BK	Background.	Low	High throughput. Bulk data that requires maximum throughput and is not time-sensitive is sent to this queue (FTP data, for example).
AC_BE	Best Effort	Medium	Medium throughput and delay. Most traditional IP data is sent to this queue
AC_VI	Video	High	Minimum delay. Time-sensitive video data is automatically sent to this queue
AC_VO	Voice	High	Time-sensitive data like VoIP and streaming media are automatically sent to this queue

Configuring QoS options consists of setting parameters on existing queues for different types of wireless traffic. You can configure different minimum and maximum wait times for the transmission of packets in each queue based on the requirements of the media being sent. Queues automatically provide minimum transmission delay for Voice, Video, multimedia, and mission critical applications, and rely on best-effort

Queue	Data Transmitted Clients to AP	Priority	Description
AC_BK	Background.	Low	High throughput. Bulk data that requires maximum throughput and is not time-sensitive is sent to this queue (FTP data, for example).
AC_BE	Best Effort	Medium	Medium throughput and delay. Most traditional IP data is sent to this queue
AC_VI	Video	High	Minimum delay. Time-sensitive video data is automatically sent to this queue
AC_VO	Voice	High	Time-sensitive data like VoIP and streaming media are automatically sent to this queue

parameters for traditional IP data.

As an Example, time-sensitive Voice & Video, and multimedia are given effectively higher priority for transmission (lower wait times for channel access), while other applications and traditional IP data which are less time-sensitive but often more data-intensive are expected to tolerate longer wait times.

- **Aifsn**: The Arbitration Inter-Frame Spacing Number specifies a wait time (in milliseconds) for data frames
- **CWmin**: Minimum Contention Window. This parameter is input to the algorithm that determines the initial random back-off wait time ("window") for retry of a transmission. The value specified here in the Minimum Contention Window is the upper limit (in milliseconds) of a range from which the initial random back-off wait time is determined.
- **CWmax**: Maximum Contention Window. The value specified here in the Maximum Contention Window is the upper limit (in milliseconds) for the doubling of the random back-off value. This doubling continues until either the data frame is sent or the Maximum Contention Window size is reached. Once the Maximum Contention Window size is reached, retries will continue until a maximum number of retries allowed is reached. Valid values for the "cwmax" are 1, 3, 7, 15, 31, 63, 127, 255, 511, or 1024. The value for "cwmax" must be higher than the

value for "cwmin".

- **Txop**: Transmission Opportunity is an interval of time when a WME AP has the right to initiate transmissions onto the wireless medium (WM). This value specifies (in milliseconds) the Transmission Opportunity (TXOP) for AP; that is, the interval of time when the WMM AP has the right to initiate transmissions on the wireless network.
- **ACM**: Admission Control Mandatory, ACM only takes effect on AC_VI and AC_VO. When you do not click Checkbox, it means that the ACM is controlled by the connecting AP. If you click Checkbox, it means that the Client is in charge.
- **AckPolicy**: Acknowledgment Policy, WMM defines two ACK policies: **Normal ACK** and **No ACK**. Click "**Checkbox**" indicates "**No ACK**"

When the no acknowledgment (No ACK) policy is used, the recipient does not acknowledge received packets during wireless packet exchange. This policy is suitable in the environment where communication quality is fine and interference is weak. While the No ACK policy helps improve transmission efficiency, it can cause increased packet loss when communication quality deteriorates. This is because when this policy is used, a sender does not retransmit packets that have not been received by the recipient. When the Normal ACK policy is used, the recipient acknowledges each received unicast packet.

- **WMM Parameters of Station**: *This affects traffic flowing from the client station to the access point.*
- **Aifsn** : The Arbitration Inter-Frame Spacing Number specifies a wait time (in milliseconds) for data frames
- **CWmin** : Minimum Contention Window. This parameter is input to the algorithm that determines the initial random backoff wait time ("window") for retry of a transmission. The value specified here in the Minimum Contention Window is the upper limit (in milliseconds) of a range from which the initial random backoff wait time is determined.
- **CWmax** : Maximum Contention Window. The value specified here in the Maximum Contention Window is the upper limit (in milliseconds) for the doubling of the random backoff value. This doubling continues until either the data frame is sent or the Maximum Contention Window size is reached. Once the Maximum Contention Window size is reached, retries will continue until a maximum number of retries allowed is reached. Valid values for the "cwmax" are 1, 3, 7, 15, 31, 63, 127, 255, 511, or 1024. The value for "cwmax" must be higher than the value for "cwmin".
- **Txop** : Transmission Opportunity is an interval of time when a WME AP has the

right to initiate transmissions onto the wireless medium (WM). This value specifies (in milliseconds) the Transmission Opportunity (Txop) for AP; that is, the interval of time when the WMM AP has the right to initiate transmissions on the wireless network.

- o **ACM:** Admission Control Mandatory, ACM only takes effect on AC_VI and AC_VO. When you do not click Checkbox, it means that the ACM is controlled by the connecting AP. If you click Checkbox, it means that the Client is in charge.

Click **Save** button to save your changes. Click **Reboot** button to activate your changes. The items in this page are for AP's RF advanced settings and will be applied to **all VAPs** and **WDS Links**.

WDS Setup

The administrator could create WDS Links to expand wireless network. When WDS is enabled, access point functions as a wireless bridge and is able to communicate with other access points via WDS links. **A WDS link is bidirectional and both side must support WDS. Access points know each other by MAC Address. In other words, each access point needs to include MAC address of its peer. Ensure all access points are configured with the same channel and own same security type settings.**

enabled.

- o **WEP Key:** Enter **5 / 13 ASCII** or **10 / 26 HEX** format WEP key.
- o **TKIP Key:** Enter **8 to 63 ASCII** or **64 HEX** format TKIP key.
- o **AES Key:** Enter **8 to 63 ASCII** or **64 HEX** format AES key.

- **WDS MAC List**

- o **Enable:** Click **Enable** to create WDS link.
- o **WDS Peer's MAC Address:** Enter the MAC address of WDS peer.
- o **Description:** Description of WDS link.

Click **Save** button to save your changes. Click **Reboot** button to activate your changes

System Status

This section breaks down into subsections of **System Overview, Associated Clients Status, WDS Link Status, Extra Information** and **Event Log**.

System Overview

Display detailed information of **System, Network, LAN and Wireless** in the System Overview page.

- **Device Information:** Display the information of the system.

Security			
Security Type	Disable		
WDS MAC List			
#	Enable	WDS Peer's MAC Address	Description
1	<input type="checkbox"/>	: : : : :	
2	<input type="checkbox"/>	: : : : :	
3	<input type="checkbox"/>	: : : : :	
4	<input type="checkbox"/>	: : : : :	

- **Security Type:** Option is "Disable", "WEP", "TKIP" or "AES" from drop-down list. Needs the same type to build WDS links. Security type takes effect when WDS is

Device Information	
Mode	AP
Host Name	TEW-738APBO
Host Description	10dBi Outdoor PoE Access Point
Firmware Version	V1.0.19
Firmware Date	2014/04/23 09:44:51
Country	US
System Time	2013/07/09 00:35:09
System Up Time	8 Day 00:35:27
ETH1 MAC	00:22:AA:00:11:07
ETH2 MAC	00:22:AA:00:11:06
Wireless MAC	00:22:AA:00:11:08
CPU Loading	0%
Memory Used	71%

- **Operating Mode:** The mode currently in service.
 - **Host Name:** The name of the system.
 - **Host Description:** A description of the system.
 - **Firmware Version:** The current installed firmware version.
 - **Firmware Date:** The build time of installed firmware.
 - **Device Time:** The current time of the system.
 - **System Up Time:** The time period that system has been in service since last reboot.
 - **ETH1/ETH2MAC:** Ethernet MAC address of the access point.
 - **Wireless MAC:** Wireless MAC address of the access point
 - **CPU Loading:** The CPU loading of the access point
 - **Memory Used:** Memory usage of the access point.
- **LAN Information:** Display total received and transmitted statistics on the LAN interface.

LAN Information	
Ethernet Connection Type	Static IP
IP Address	192.168.10.100
IP Netmask	255.255.255.0
IP Gateway	192.168.10.1
DNS	

- **Ethernet Connection Type:** The connection applied on the access point.
 - **IP Address:** The management IP of system. By default, it's 192.168.2.254.
 - **IP Netmask:** The network mask. By default, it's 255.255.255.0.
 - **IP Gateway:** The gateway IP addresses and by default, it's 192.168.2.1.
 - **Primary DNS:** The primary DNS server in service.
- **Wireless Information:** Display total received and transmitted statistics on available Virtual AP.

Wireless Information	
WiFi	On
Band	802.11b/g/n
Channel	5
Current Txpower	28 dBm (630 mW)
Data Rate	Auto (300Mb/s)

- **WiFi:** Wireless status of the access point.
- **Band:** Operating wireless band of the access point.
- **Channel:** Operating channel of the access point.
- **Current Tx Power:** Transmit power of the access point.
- **Data Rate:** Current wireless data rate of the access point.

Extra Information

Users could pull out information such as Route table, ARP table, MAC table, Bridge table or STP available in the drop-down list from system. The "Refresh" button is used to retrieve latest table information.

Extra Information			
Information	Route Information		
Route Information			
Destination	Gateway	Netmask	Interface
192.168.10.0	0.0.0.0	255.255.255.0	bre0
239.0.0.0	0.0.0.0	255.0.0.0	bre0
224.0.0.0	0.0.0.0	224.0.0.0	bre0
0.0.0.0	192.168.10.1	0.0.0.0	bre0

- **Route table information:** Select "Route table information" on the drop-down list to display route table. The access point could be used as a L2 or L3 device. It doesn't support dynamic routing protocols such as RIP or OSPF. Static routes to specific hosts, networks or default gateway are set up automatically according to the IP configuration of system's interfaces. When used as a L2 device, it could

switch packets and, as L3 device, it's capable of being a gateway to route packets inward and outward.

Route Information			
Destination	Gateway	Netmask	Interface
192.168.10.0	0.0.0.0	255.255.255.0	bre0
239.0.0.0	0.0.0.0	255.0.0.0	bre0
224.0.0.0	0.0.0.0	224.0.0.0	bre0
0.0.0.0	192.168.10.1	0.0.0.0	bre0

- **ARP table Information:** Select “**ARP Table Information**” on the drop-down list to display ARP table. ARP associates each IP address to a unique hardware address (MAC) of a device. It is important to have a unique IP address as final destination to switch packets to.

ARP Table Information		
IP Address	MAC Address	Interface
192.168.10.123	00:26:2d:5b:46:53	bre0

- **Bridge table information:** Select “**Bridge Table information**” on the drop-down list to display bridge table. Bridge table will show Bridge ID and STP's Status on the each Ethernet bridge and its attached interfaces, the Bridge Port should be attached to some interfaces (e.g. eth2, ra0~ra6 and wds0~wds3).

Bridge Table Information			
Bridge Port	Bridge ID	STP Enabled	Interface
LAN	8000.0022aa001106	no	eth1
			eth0
			ath0

- **Bridge MAC information:** Select “**Bridge MACs Information**” on the drop-down list to display MAC table.

Bridge MACs Table Information			
Port	MAC Address	Local	Ageing Timer
VAP0	00:14:d1:c2:da:84	no	3.17
LAN	00:22:aa:00:11:06	yes	0.00
WAN	00:22:aa:00:11:07	yes	0.00
VAP0	00:22:aa:00:11:08	yes	0.00
WAN	00:26:2d:5b:46:53	no	0.04

This table displays local MAC addresses associated with wired or wireless interfaces, but also remember non-local MAC addresses learned from wired or wireless interfaces. Ageing timers will be reset when existing MAC addresses in table are learned again or added when new MAC addresses are seen from wired or wireless interfaces as well. When time runs out for a particular entry, it will be pruned from the table. In that situation, switching packet to that particular MAC address will be dropped.

Event Log

The Event log displays system events when system is up and running. Also, it becomes very useful as a troubleshooting tool when issues are experienced in system.

Time	Facility	Severity	Message
2013-07-06 03:32:47	System	Info	Authentication successful for admin from 192.168.10.123

- **Time:** The date and time when the event occurred.
- **Facility:** It helps users to identify source of events such “System” or “User”
- **Severity:** Severity level that a specific event is associated such as “info”, “error”, “warning”, etc.
- **Message:** Description of the event.

Click **Refresh** button to renew the log, or click **Clear** button to clear all the record.

WDS Link Status

Peers MAC Address, antenna 0/1 received signal strength, phy mode and channel bandwidth for each WDS are available.

#	MAC Address	RSSI	TX/RX Rate	TX/RX SEQ	TX/RX Bytes
No WDS Link!					

- **MAC Address:** Display MAC address of WDS peer.
- **RSSI:** Indicate the signal strength of the respective WDS links.
- **TX/RX SEQ:** Transmit and receive sequence.
- **TX/RX Bytes:** Transmit and receive bytes

Repeater Mode

When Universal Repeater mode is activated, the system can be configured as an **Access Point** and **Client Station** simultaneously. This section provides information in configuring the Client Bridge+Universal Repeater mode with graphical illustrations. The access point provides functions as stated below where they can be configured via a user-friendly web based interface.

External Network Connection

Network Requirement

It can be used as a Client Bridge or Universal Repeater to receive and repeat wireless signal over last mile applications, helping WISPs deliver wireless broadband Internet service to new residential and business customers. In this mode, the access point is enabled with DHCP Server functions. The wired clients of the access point are in **the same** subnet from Main Base Station and it **accepts** wireless connections from wireless client devices.

Universal Repeater mode network Configuration

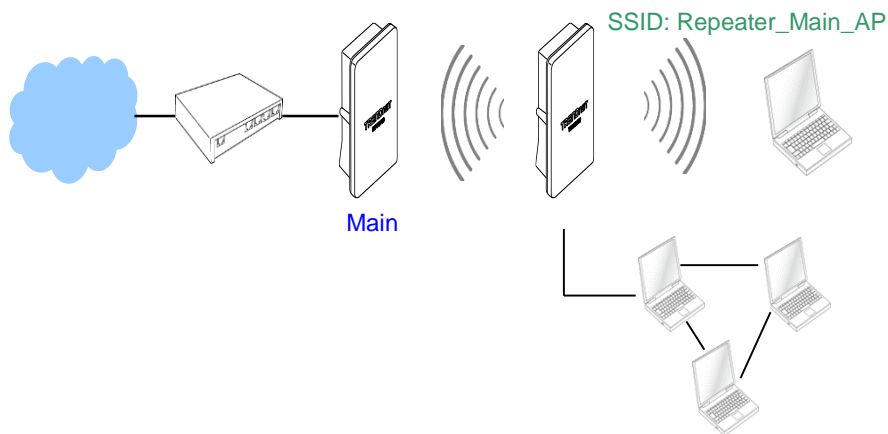

Configure LAN IP

Here are the instructions to setup the local IP Address and Netmask.

Please click on **System** -> **LAN** and follow the below setting.

- **Mode:** Check either “Static IP” or “Dynamic IP” button as desired to set up the system IP of LAN port.

Ethernet Connection Type	
Mode	<input checked="" type="radio"/> Static IP <input type="radio"/> Dynamic IP
Static IP	
IP Address	<input type="text" value="192.168.10.100"/>
IP Netmask	<input type="text" value="255.255.255.0"/>
IP Gateway	<input type="text" value="192.168.10.1"/>

- **Static IP:** The administrator can manually setup the LAN IP address when static IP is available/ preferred.
 - **IP Address :** The IP address of the LAN port; default IP address is 192.168.2.254
 - **IP Netmask :** The Subnet mask of the LAN port; default Netmask is 255.255.255.0
 - **IP Gateway :** The default gateway of the LAN port; default Gateway is 192.168.2.1
- **Dynamic IP :** This configuration type is applicable when the access point is connected to a network with the presence of a DHCP server; all related IP information will be provided by the DHCP server automatically.

Dynamic IP	
Hostname	<input type="text"/>

- **Hostname :** The Hostname of the LAN port
- **DNS:** Check either “No Default DNS Server” or “Specify DNS Server IP” button as desired to set up the system DNS.

DNS	
DNS	<input checked="" type="radio"/> No Default DNS Server <input type="radio"/> Specify DNS Server IP
Primary DNS	<input type="text"/>
Secondary DNS	<input type="text"/>

- **Primary:** The IP address of the primary DNS server.

- **Secondary:** The IP address of the secondary DNS server.

- **802.1d Spanning Tree**

802.1d Spanning Tree	
Service	<input checked="" type="radio"/> Enable <input type="radio"/> Disable

The spanning tree network protocol provides a loop free topology for a bridged LAN between LAN interface and 4 WDS interfaces from wds0 to wds3. The Spanning Tree Protocol, which is also referred to as STP, is defined in the IEEE Standard 802.1d. Spanning tree always disabled on the access point. Below Figures depict a loop for a bridged LAN between LAN and WDS link

- **DHCP Setup:** Devices connected to the system can obtain an IP address automatically when this service is enabled.

DHCP Server	
Service	<input checked="" type="radio"/> Enable <input type="radio"/> Disable
Start IP	192.168.10.101
End IP	192.168.10.254
Default Gateway	192.168.10.100
DNS1 IP	192.168.10.100
DNS2 IP	
WINS IP	
Domain	
Lease Time	86400

- **DHCP:** Check **Enable** button to activate this function or **Disable** to deactivate this service.
- **Start IP / End IP:** Specify the range of IP addresses to be used by the DHCP server when assigning IP address to clients. The default range IP address is 192.168.2.10 to 192.168.2.70, the netmask is 255.255.255.0
- **DNS1 IP:** Enter IP address of the first DNS server; this field is required.
- **DNS2 IP:** Enter IP address of the second DNS server; this is optional.
- **WINS IP:** Enter IP address of the Windows Internet Name Service (WINS) server; this is optional.
- **Domain:** Enter the domain name for this network.

- **Lease Time:** The IP addresses given out by the DHCP server will only be valid for the duration specified by the lease time. Increasing the time ensure client operation without interruptions, but could introduce potential conflicts. Lowering the lease time will avoid potential address conflicts, but might cause more interruptions to the client while it will acquire new IP addresses from the DHCP server. Default is **86400** seconds

Click **Save** button to save your changes. Click **Reboot** button to activate your changes

Wireless Network Expansion

The network manager can configure related wireless settings, **General Settings**, **Advanced Settings** and **WDS Settings**.

Wireless General Setup

The administrator can change the data transmission, channel and output power settings for the system. Please click on **Wireless -> General Setup** and follow the below setting.

General Setup	
MAC Address	00:22:aa:00:11:08
Band Mode	802.11b/g/n
Channel	Auto <input type="button" value="Auto Scan"/>
Tx Power	Level 9
RF(ON/OFF) Schedule	Always Run

- **MAC Address:** The MAC address of the Wireless interface is displayed here.
- **Band Mode:** Select an appropriate wireless band; bands available are 801.11b, 802.11b/g, 802.11b/g/n or 802.11n only.
- **Channel:** Select the desired channel from the drop-down list to have the access point operate on. Click **Auto Scan** to scan for the best available channel to use based on the environment.
- **Tx Power:** You can adjust the output power of the system to get the appropriate coverage for your wireless network. Specify digit numbers between 1 to 100 (the unit is %) for your environment. If you are not sure which setting to choose, then keep the default setting, **100%**.
- **RF (ON/OFF) Schedule:** Select an assigned schedule of when to have the access point turn on. Select **Always Run** to have the access point always on.

When **Band Mode** select in **802.11a only mode**, the **HT(High Throughput)** settings should be hidden immediately.

HT Physical Mode	
TX/RX Stream	<input type="radio"/> 1 <input checked="" type="radio"/> 2
Channel BandWidth	<input type="radio"/> 20 <input checked="" type="radio"/> 20/40
Extension Channel	<input type="radio"/> Upper <input checked="" type="radio"/> Lower
MCS	Auto ▾
Short GI	<input type="radio"/> Disbale <input checked="" type="radio"/> Enable
Aggregation	<input type="radio"/> Disbale <input checked="" type="radio"/> Enable
Aggregation Frames	32
Aggregation Size	50000

- **TxStream/Rx Stream:** Select the amount of transmit (TX) and Receive (RX) streams. By default, it's 2.
- **Channel Bandwidth:** The "20/40" MHz option is usually best. The other option is available for special circumstances.
- **Extensions Channel:** Select which section of channels to use for extension channels.
- **MCS:** This parameter represents transmission rate. By default (Auto) the fastest possible transmission rate will be selected. You have the option of selecting the speed if necessary. (Refer to **Appendix C. MCS Data Rate**)

Wireless Advanced Setup

To achieve optimal wireless performance, it is necessary to tweak advance setting per requirements properly, not necessary higher the better or lower. The administrator can change the RTS threshold and fragmentation threshold settings for the system. Please click on **Wireless -> Advanced Setup** and follow the below setting.

Advanced Setup	
Slot Time	9 <input type="text"/> Distance <input type="text"/>
ACK Timeout	64 <input type="text"/>
Beacon Interval	100 <input type="text"/>
DTIM Interval	1 <input type="text"/>
RTS Threshlod	2346 <input type="text"/>
Short Preamble	<input checked="" type="radio"/> Enable <input type="radio"/> Disbale
IGMP Snooping	<input type="radio"/> Enable <input checked="" type="radio"/> Disbale
Greenfield	<input checked="" type="radio"/> Enable <input type="radio"/> Disbale
WMM	<input checked="" type="radio"/> Enable <input type="radio"/> Disbale

- **Short Slot:** By default, it's "Enable" for reducing the slot time from the standard **20 microseconds** to the **9 microsecond** short slot time. Slot time is the amount of time a device waits after a collision before retransmitting a packet. Reducing the slot time decreases the overall back-off, which increases throughput. Back-off, which is a multiple of the slot time, is the random length of time a station waits before sending a packet on the LAN. For a sender and receiver own right of the channel the shorter slot time help manage shorter wait time to re-transmit from collision because of hidden wireless clients or other causes. When collision sources can be removed sooner and other senders attempting to send are listening the channel (CSMA/CA) the owner of the channel should continue ownership and finish their transmission and release the channel. Then, following ownership of the channel will be sooner for the new pair due to shorter slot time. However, when long duration of existing collision sources and shorter slot time exist the owners might experience subsequent collisions. When adjustment to longer slot time can't improve performance then RTS/CTS could supplement and help improve performance.
- **ACK Timeout:** ACK timeout is in the range of **1~255** and set in unit of **microsecond**. The default value is **32** microsecond. All data transmission in 802.11b/g request an "Acknowledgement" (ACK) send by receiving radio. The transmitter will resend the original packet if correspondent ACK failed to arrive within specific time interval, also refer to as "ACK Timeout".

ACK Timeout is adjustable due to the fact that distance between two radio links may vary in different deployment. ACK Timeout makes significant influence in performance of long distance radio link. If ACK Timeout is set too short, transmitter

will start to “Resend” packet before ACK is received, and throughputs become low due to excessively high re-transmission. ACK Timeout is best determined by distance between the radios, data rate of average environment. The Timeout value is calculated based on round-trip time of packet with a little tolerance, So, if experiencing re-transmissions or poor performance the ACK Timeout could be made longer to accommodate.

- **Beacon Interval::** Beacon Interval is in the range of **20~1024** and set in unit of *millisecond*. The default value is **100** msec.

Access Point (AP) in IEEE 802.11 will send out a special approximated 50-byte frame, called “Beacon”. Beacon is broadcast to all the stations, provides the basic information of AP such as SSID, channel, encryption keys, signal strength, time stamp, support data rate.

All the radio stations received beacon recognizes the existence of such AP, and may proceed next actions if the information from AP matches the requirement. Beacon is sent on a periodic basis, the time interval can be adjusted.

By increasing the beacon interval, you can reduce the number of beacons and associated overhead, but that will likely delay the association and roaming process because stations scanning for available access points may miss the beacons. You can decrease the beacon interval, which increases the rate of beacons. This will make the association and roaming process very responsive; however, the network will incur additional overhead and throughput will go down.

- **DTIM Interval:** The DTIM interval is in the range of **1~255**. The default is **1**.
DTIM is defined as *Delivery Traffic Indication Message*. It is used to notify the wireless stations, which support power saving mode, when to wake up to receive multicast frame. DTIM is necessary and critical in wireless environment as a mechanism to fulfill power-saving synchronization. A DTIM interval is a count of the number of beacon frames that must occur before the access point sends the buffered multicast frames. For instance, if DTIM Interval is set to 3, then the Wi-Fi clients will expect to receive a multicast frame after receiving three Beacon frame. The higher DTIM interval will help power saving and possibly decrease wireless throughput in multicast applications.
- **RTS Threshold:** TRTS Threshold is in the range of **1~2347** byte. The default is **2347** byte. The main purpose of enabling RTS by changing RTS threshold is to reduce possible collisions due to hidden wireless clients. RTS in AP will be enabled automatically if the packet size is larger than the Threshold value. By default, RTS is disabled in a normal environment supports non-jumbo frames.
- **Short Preamble:** By default, it's “**Enable**”. To **Disable** is to use Long 128-bit

Preamble Synchronization field. The preamble is used to signal "here is a train of data coming" to the receiver. The short preamble provides 72-bit Synchronization field to improve WLAN transmission efficiency with less overhead.

- **WMM:** By default, it's “**Enabled**”.
- **Signal LED Threshold:**

Signal LED Thresholds			
LED Indicator	LED1	LED2	LED3
Thresholds, RSSI	20	30	40

- **LED1:** Set the RSSI reading when LED1 will activate.
- **LED2:** Set the RSSI reading when LED2 will activate.
- **LED3:** Set the RSSI reading when LED3 will activate.

Change these settings as described here and click **Save** button to save your changes. Click **Reboot** button to activate your changes.

Wireless WMM QoS Setup

To achieve optimal wireless performance, it is necessary to tweak advance setting per requirements properly, not necessary higher the better or lower.

The administrator can change the RTS threshold and fragmentation threshold settings for the system. Please click on **Wireless -> Advanced**

WMM QoS					
WMM Parameters of Access Point					
AC Type	CWmin	CWmax	AIFS	TxOp Limit	No ACK Policy bit
AC_BE(0)	4	6	3	0	<input type="checkbox"/>
AC_BK(1)	4	10	7	0	<input type="checkbox"/>
AC_VI(2)	3	4	1	3008	<input type="checkbox"/>
AC_VO(3)	2	3	1	1504	<input type="checkbox"/>
WMM Parameters of Station					
AC Type	CWmin	CWmax	AIFS	TxOp Limit	ACM bit
AC_BE(0)	4	10	3	0	<input type="checkbox"/>
AC_BK(1)	4	10	7	0	<input type="checkbox"/>
AC_VI(2)	3	4	2	3008	<input type="checkbox"/>
AC_VO(3)	2	3	2	1504	<input type="checkbox"/>

- **WMM Parameters of Access Point** : This affects traffic flowing from the access point to the client station

Queue	Data Transmitted AP to Clients	Priority	Description
AC_BK	Background.	Low	High throughput. Bulk data that requires maximum throughput and is not time-sensitive is sent to this queue (FTP data, for example).
AC_BE	Best Effort	Medium	Medium throughput and delay. Most traditional IP data is sent to this queue
AC_VI	Video	High	Minimum delay. Time-sensitive video data is automatically sent to this queue

AC_VO	Voice	High	Time-sensitive data like VoIP and streaming media are automatically sent to this queue
-------	-------	------	--

Configuring QoS options consists of setting parameters on existing queues for different types of wireless traffic. You can configure different minimum and maximum wait times for the transmission of packets in each queue based on the requirements of the media being sent. Queues automatically provide minimum transmission delay for Voice, Video, multimedia, and mission critical applications, and rely on best-effort parameters for traditional IP data.

As an Example, time-sensitive Voice & Video, and multimedia are given effectively higher priority for transmission (lower wait times for channel access), while other applications and traditional IP data which are less time-sensitive but often more data-intensive are expected to tolerate longer wait times.

- **Aifsn**: The Arbitration Inter-Frame Spacing Number specifies a wait time (in milliseconds) for data frames
- **CWmin**: Minimum Contention Window. This parameter is input to the algorithm that determines the initial random back-off wait time ("window") for retry of a transmission. The value specified here in the Minimum Contention Window is the upper limit (in milliseconds) of a range from which the initial random back-off wait time is determined.
- **CWmax**: Maximum Contention Window. The value specified here in the Maximum Contention Window is the upper limit (in milliseconds) for the doubling of the random back-off value. This doubling continues until either the data frame is sent or the Maximum Contention Window size is reached. Once the Maximum Contention Window size is reached, retries will continue until a maximum number of retries allowed is reached. Valid values for the "cwmax" are 1, 3, 7, 15, 31, 63, 127, 255, 511, or 1024. The value for "cwmax" must be higher than the value for "cwmin".
- **Txop**: Transmission Opportunity is an interval of time when a WME AP has the right to initiate transmissions onto the wireless medium (WM). This value specifies (in milliseconds) the Transmission Opportunity (TXOP) for AP; that is, the interval of time when the WMM AP has the right to initiate transmissions on the wireless network.
- **ACM**: Admission Control Mandatory, ACM only takes effect on AC_VI and AC_VO. When you do not click Checkbox, it means that the ACM is controlled by the connecting AP. If you click Checkbox, it means that the Client is in charge.
- **AckPolicy**: Acknowledgment Policy, WMM defines two ACK policies: **Normal ACK** and **No ACK**. Click "Checkbox" indicates "No ACK"

Queue	Data Transmitted Clients to AP	Priority	Description
AC_BK	Background.	Low	High throughput. Bulk data that requires maximum throughput and is not time-sensitive is sent to this queue (FTP data, for example).
AC_BE	Best Effort	Medium	Medium throughput and delay. Most traditional IP data is sent to this queue
AC_VI	Video	High	Minimum delay. Time-sensitive video data is automatically sent to this queue
AC_VO	Voice	High	Time-sensitive data like VoIP and streaming media are automatically sent to this queue

When the no acknowledgment (No ACK) policy is used, the recipient does not acknowledge received packets during wireless packet exchange. This policy is suitable in the environment where communication quality is fine and interference is weak. While the No ACK policy helps improve transmission efficiency, it can cause increased packet loss when communication quality deteriorates. This is because when this policy is used, a sender does not retransmit packets that have not been received by the recipient. When the Normal ACK policy is used, the recipient acknowledges each received unicast packet.

- **WMM Parameters of Station:** *This affects traffic flowing from the client station to the access point.*
 - **Aifsn :** The Arbitration Inter-Frame Spacing Number specifies a wait time (in milliseconds) for data frames
 - **CWmin :** Minimum Contention Window. This parameter is input to the algorithm that determines the initial random backoff wait time ("window") for retry of a transmission. The value specified here in the Minimum Contention Window is the upper limit (in milliseconds) of a range from which the initial random backoff wait time is determined.
 - **CWmax :** Maximum Contention Window. The value specified here in the

Maximum Contention Window is the upper limit (in milliseconds) for the doubling of the random backoff value. This doubling continues until either the data frame is sent or the Maximum Contention Window size is reached. Once the Maximum Contention Window size is reached, retries will continue until a maximum number of retries allowed is reached. Valid values for the "cwmax" are 1, 3, 7, 15, 31, 63, 127, 255, 511, or 1024. The value for "cwmax" must be higher than the value for "cwmin".

- **Txop:** Transmission Opportunity is an interval of time when a WME AP has the right to initiate transmissions onto the wireless medium (WM). This value specifies (in milliseconds) the Transmission Opportunity (Txop) for AP; that is, the interval of time when the WMM AP has the right to initiate transmissions on the wireless network.
- **ACM:** Admission Control Mandatory, ACM only takes effect on AC_VI and AC_VO. When you do not click Checkbox, it means that the ACM is controlled by the connecting AP. If you click Checkbox, it means that the Client is in charge.

Click **Save** button to save your changes. Click **Reboot** button to activate your changes. The items in this page are for AP's RF advanced settings and will be applied to **all VAPs** and **WDS Links**.

Site Survey

Use this tool to scan and locate WISP Access Points and select one to associate with. Please click on **Wireless -> Site Survey**. Below depicts an example for site survey.

ESSID	MAC Address	Signal/Noise, dBm	RSSI	Signal Quality, %	Channel	Security	Select
WalkingDead	00:E0:4C:81:86:82	-29 / -95	66	100%	1	WPA2-PSK/AES	Select
TRENDnet639RMA	D8:EB:97:A5:90:EC	-41 / -95	54	100%	1	WPA-PSK/AES	Select
TrendnetSkyN	00:14:D1:C5:7D:44	-69 / -95	26	76%	1	WPA2-PSK/AES	Select
TRENDnet815_2.4GHz_3272	00:11:E0:04:96:AD	-30 / -95	65	100%	1	WPA2-PSK/AES	Select
ATT048	90:B1:34:80:53:60	-79 / -95	16	42%	1	WPA-PSK/AES	Select
V72	D8:EB:97:BC:18:EC	-62 / -95	33	92%	1	WPA2-PSK/AES	Select
TRENDnet752_2.4GHz_0019	D0:AE:EC:C4:E3:C0	-32 / -95	63	100%	7	WPA2-PSK/AES	Select
TrendnetSkyN	00:14:D1:CF:3F:0C	-48 / -95	47	100%	11	WPA2-PSK/AES	Select

- **ESSID:** Available Extend Service Set ID of surrounding Access Points.
- **MAC Address:** MAC addresses of surrounding Access Points.

- **Signal:** Received signal strength of all found Access Points.
- **Channel:** Channel numbers used by all found Access Points.
- **Security:** Security type by all found Access Points.
- **Band:** Wireless band used by all found Access Points.
- **Network Type:** Network type used by all found Access Points.
- **Select:** Click "Select" to configure settings and associate with chosen AP.

Repeater AP Setup

The administrator can configure station profiles via this page.

Please click on **Wireless -> Wireless Profile** and follow the below setting.

Security	
ESSID	Repeater AP
Enable Repeater AP	<input type="radio"/> Enable <input checked="" type="radio"/> Disable
Hidden SSID	<input type="radio"/> Enable <input checked="" type="radio"/> Disable
Client Isolation	<input type="radio"/> Enable <input checked="" type="radio"/> Disable
IAPP	<input type="radio"/> Enable <input checked="" type="radio"/> Disable
Maximum Clients	32
Security Type	Disable

- **ESSID:** Assign Service Set ID for the wireless system.
- **Enable Repeater SSID:** Select **Enable** to broadcast the repeated signal.
- **Hidden SSID:** Select **Enable** to broadcast the access point's SSID.
- **Client Isolation:** Select **Enable** to isolate wireless clients from each other.
- **IAPP:**
- **Maximum Clients:** Enter the amount of wireless clients allowed to connect to the access point.
- **Security Type:** Select the desired security type from the drop-down list; the options are **Disable**, **WEP**, **WPA-PSK**, **WPA2-PSK**, **WPA-Enterprise**, **WPA2-Enterprise** and **WEP 802.1X**.
 - **Disable:** Data are unencrypted during transmission when this option is selected.

WEP	
Key Length	64 bits
WEP Auth Method	<input checked="" type="checkbox"/> Open System <input type="checkbox"/> Shared
Key Index	1
WEP Key 1	
WEP Key 2	
WEP Key 3	
WEP Key 4	

- **WEP Auth Method:** Enable the desire option among **OPEN** or **SHARED**
 - **Key Index:** Key index is used to designate the WEP key during data transmission. 4 different WEP keys can be entered at the same time, but only one is chosen.
 - **WEP Key #:** Enter **HEX** or **ASCII** format WEP key value; the system supports up to 4 sets of WEP keys.
- **WPA-PSK (or WPA2-PSK):** WPA (or WPA2) Algorithms, allows the system accessing the network by using the WPA-PSK protected access.

WPA General	
Cipher Suite	<input type="radio"/> AES <input checked="" type="radio"/> TKIP
Group Key Update Period	600
Master Key Update Period	83400
Key Type	<input checked="" type="radio"/> ASCII <input type="radio"/> HEX
Pre-shared Key	

- **Cipher Suite:** By default, it is **AES**. Select either AES or TKIP cipher suites
- **Group Key Update Period:** By default, it is **600** seconds. This time interval for rekeying GTK, broadcast/multicast encryption keys, in seconds. Entering the time-length is required.
- **Master Key Update Period:** By default, it is **83499** seconds. This time interval for rekeying GTK, broadcast/multicast encryption keys, in seconds. Entering the time-length is required.

- **Pre-shared Key:** Enter the pre-shared key; the format shall go with the selected key type.
- **WPA-Enterprise (or WPA2-Enterprise):** The RADIUS authentication and encryption will be both enabled if this is selected.

WPA General	
Cipher Suite	<input type="radio"/> AES <input checked="" type="radio"/> TKIP
Group Key Update Period	<input type="text" value="600"/>
Master Key Update Period	<input type="text" value="83400"/>
EAP Reauth Period	<input type="text" value="3600"/>
Authentication RADIUS Server	
Server IP	<input type="text"/>
Port	<input type="text" value="1812"/>
Shared Secret	<input type="text"/>
Accounting RADIUS Server	<input type="radio"/> Enable <input checked="" type="radio"/> Disable

- **WPA General Settings:**
 - **Cipher Suite:** By default, it is AES. Select either AES or TKIP cipher suites
 - **Group Key Update Period:** By default, it's **3600** seconds. This time interval for rekeying GTK, broadcast/multicast encryption keys, in seconds. Entering the time-length is required.
 - **Master Key Update Period:** By default, it is **83499** seconds. This time interval for rekeying GTK, broadcast/multicast encryption keys, in seconds. Entering the time-length is required.
 - **EAP Reauth Period:** By default, it's **3600** seconds. Set **WPA2** PMKID cache timeout period, after time out, the cached key will be deleted.
 - **Pre-Authentication:** By default, it's "Disable". To Enable is use to speed up roaming before pre-authenticating IEEE 802.1X/EAP part of the full RSN authentication and key handshake before actually associating with a new AP.
- **Radius Server Settings:**
 - **IP Address:** Enter the IP address of the Authentication RADIUS server.
 - **Port:** By default, it's 1812. The port number used to communicate with RADIUS server.

- **Shared secret:** A secret key used between system and RADIUS server. Supports 8 to 64 characters.
- **Accounting RADIUS Server:** Enable to set Account RADIUS server.
- **WEP 802.1X:** When WEP 802.1x Authentication is enabled, please refer to the following Dynamic WEP and RADIUS settings to complete configuration.

Dynamic WEP Setting	
WEP Key Length	<input checked="" type="radio"/> 64bits <input type="radio"/> 128bits
WEP Key Update Period	<input type="text" value="300"/>
EAP Reauth Period	<input type="text" value="3600"/>
Authentication RADIUS Server	
Server IP	<input type="text"/>
Port	<input type="text" value="1812"/>
Shared Secret	<input type="text"/>
Accounting RADIUS Server	<input type="radio"/> Enable <input checked="" type="radio"/> Disable

- **Radius Server Settings:**
 - **IP Address:** Enter the IP address of the Authentication RADIUS server.
 - **Port:** By default, it's **1812**. The port number used to communicate with RADIUS server.
 - **Shared secret:** A secret key used between system and RADIUS server. Supports **8** to **64** characters.
 - **Accounting RADIUS Server:** Enable to set Account RADIUS server.
 - **Key Index:** key index is used to designate the WEP key during data transmission. 4 different WEP keys can be entered at the same time, but only one is chosen.
 - **WEP Key # :** Enter **HEX** or **ASCII** format WEP key value; the system supports up to 4 sets of WEP keys.
 - **WPA-PSK (or WPA2-PSK):** WPA (or WPA2) Algorithms, allows the system accessing the network by using the WPA-PSK protected access.

Wireless MAC Filter Setup

The administrator can allow or reject clients to access Repeater AP.

MAC Rules	
Action	Disable <input type="button" value="Save"/>
ACL MAC Address	
MAC Address	<input type="text"/> <input type="button" value="Add"/>

- **MAC Filter Setup:** By default, it's "**Disable**". Options are **Disable**, **Only Deny List MAC** or **Only Allow List MAC**.
- **MAC Filter Setup:** Two ways to set MAC filter rules:
 - **Only Allow List MAC:** The wireless clients in the "**Enable**" list will be **allowed** to access the Access Point; All others or clients in the "**Disable**" list will be **denied**.
 - **Only Deny List MAC:** The wireless clients in the "**Enable**" list will be **denied** to access the Access Point; All others or clients in the "**Disable**" list will be **allowed**.
- **MAC:** Enter MAC address (e.g. aa:bb:cc:00:00:0a) and click "**Add**" button, then the MAC address should display in the "**Enable**" List.

There are a maximum of **20** clients allowed in this "**Enable**" List. The MAC addresses of the wireless clients can be added and removed to the list using the **Add** and **Remove** buttons. Click **Apply** button to activate your changes

Create Wireless Profile

The administrator can configure station profiles via this page. Please click on **Wireless -> Wireless Profile** and follow the below setting.

- **Connection Setup:** Select the repeater connection type.

Connection Setup	
Connection Setup	<input checked="" type="radio"/> Fix <input type="radio"/> Cycle

- **Fix:** Select to have access point fixed on one profile to repeat
- **Cycle:** Select to have access point cycle through different profiles.

- **General Configuration:**

General Configuration	
MAC Address	00:22:AA:00:11:08
Profile Name	<input type="text"/>
ESSID	<input type="text"/>
Lock to AP MAC	<input type="text"/> (Optional)
Security Type	NONE <input type="button" value="v"/>

- **MAC Address:** The MAC address of the Wireless Station is displayed here.
- **Profile Name:** Set different profiles for quick connection uses.
- **ESSID:** Assign Service Set ID for the wireless system.
- **Lock to AP MAC:** This allows the station to always maintain connection to a particular AP with a specific MAC address. This is useful as sometimes there can be few identically named SSID's (AP's) with different MAC addresses. With AP lock on, the station will lock to MAC address and not roam between several Access Points with the same ESSID.
- **Security Type:** Select the desired security type from the drop-down list; the options are **Disable**, **WEP**, **WPA-PSK**, **WPA2-PSK**, **WPA-Enterprise**, **WPA2-Enterprise** and **WEP 802.1X**.
 - **Disable:** Data are unencrypted during transmission when this option is selected.

WEP	
Key Length	64 bits <input type="button" value="v"/>
WEP Auth Method	<input checked="" type="checkbox"/> Open System <input type="checkbox"/> Shared
Key Index	1 <input type="button" value="v"/>
WEP Key 1	<input type="text"/>
WEP Key 2	<input type="text"/>
WEP Key 3	<input type="text"/>
WEP Key 4	<input type="text"/>

- **WEP Auth Method:** Enable the desire option among **OPEN** or **SHARED**
 - **Key Index:** Key index is used to designate the WEP key during data transmission. 4 different WEP keys can be entered at the same time, but only one is chosen.

- **WEP Key #:** Enter **HEX** or **ASCII** format WEP key value; the system supports up to 4 sets of WEP keys.
- **WPA-PSK (or WPA2-PSK):** WPA (or WPA2) Algorithms, allows the system accessing the network by using the WPA-PSK protected access.

WPA General	
Cipher Suite	<input type="radio"/> AES <input checked="" type="radio"/> TKIP
Group Key Update Period	<input type="text" value="600"/>
Master Key Update Period	<input type="text" value="83400"/>
Key Type	<input checked="" type="radio"/> ASCII <input type="radio"/> HEX
Pre-shared Key	<input type="text"/>

- **Cipher Suite:** By default, it is **AES**. Select either AES or TKIP cipher suites
- **Group Key Update Period:** By default, it is **600** seconds. This time interval for rekeying GTK, broadcast/multicast encryption keys, in seconds. Entering the time-length is required.
- **Master Key Update Period:** By default, it is **83499** seconds. This time interval for rekeying GTK, broadcast/multicast encryption keys, in seconds. Entering the time-length is required.
- **Pre-shared Key:** Enter the pre-shared key; the format shall go with the selected key type.

- **WPA-Enterprise (or WPA2-Enterprise):** The RADIUS authentication and encryption will be both enabled if this is selected.

WPA General	
Cipher Suite	<input type="radio"/> AES <input checked="" type="radio"/> TKIP
Group Key Update Period	<input type="text" value="600"/>
Master Key Update Period	<input type="text" value="83400"/>
EAP Reauth Period	<input type="text" value="3600"/>
Authentication RADIUS Server	
Server IP	<input type="text"/>
Port	<input type="text" value="1812"/>
Shared Secret	<input type="text"/>
Accounting RADIUS Server	<input type="radio"/> Enable <input checked="" type="radio"/> Disable

- **WPA General Settings:**
 - **Cipher Suite:** By default, it is AES. Select either AES or TKIP cipher suites
 - **Group Key Update Period:** By default, it's **3600** seconds. This time interval for rekeying GTK, broadcast/multicast encryption keys, in seconds. Entering the time-length is required.
 - **Master Key Update Period:** By default, it is **83499** seconds. This time interval for rekeying GTK, broadcast/multicast encryption keys, in seconds. Entering the time-length is required.
 - **EAP Reauth Period:** By default, it's **3600** seconds. Set **WPA2** PMKID cache timeout period, after time out, the cached key will be deleted.
 - **Pre-Authentication:** By default, it's "Disable". To Enable is use to speed up roaming before pre-authenticating IEEE 802.1X/EAP part of the full RSN authentication and key handshake before actually associating with a new AP.
- **Radius Server Settings :**
 - **IP Address:** Enter the IP address of the Authentication RADIUS server.
 - **Port:** By default, it's 1812. The port number used to communicate with RADIUS server.
 - **Shared secret:** A secret key used between system and RADIUS server. Supports 8 to 64 characters.
 - **Accounting RADIUS Server:** Enable to set Account RADIUS server.
- **WEP 802.1X:** When WEP 802.1x Authentication is enabled, please refer to the following Dynamic WEP and RADIUS settings to complete configuration.

Dynamic WEP Setting	
WEP Key Length	<input checked="" type="radio"/> 64bits <input type="radio"/> 128bits
WEP Key Update Period	<input type="text" value="300"/>
EAP Reauth Period	<input type="text" value="3600"/>
Authentication RADIUS Server	
Server IP	<input type="text"/>
Port	<input type="text" value="1812"/>
Shared Secret	<input type="text"/>
Accounting RADIUS Server	<input type="radio"/> Enable <input checked="" type="radio"/> Disable

- **Radius Server Settings:**

- **IP Address:** Enter the IP address of the Authentication RADIUS server.
- **Port:** By default, it's **1812**. The port number used to communicate with RADIUS server.
- **Shared secret:** A secret key used between system and RADIUS server. Supports **8** to **64** characters.
- **Accounting RADIUS Server:** Enable to set Account RADIUS server.
- **Key Index:** key index is used to designate the WEP key during data transmission. 4 different WEP keys can be entered at the same time, but only one is chosen.
- **WEP Key #:** Enter **HEX** or **ASCII** format WEP key value; the system supports up to 4 sets of WEP keys.
- **WPA-PSK (or WPA2-PSK):** WPA (or WPA2) Algorithms, allows the system accessing the network by using the WPA-PSK protected access.

Bandwidth Control

Bandwidth control allows you to control the bandwidth going through the access point.

Bandwidth Control	
Service	<input type="radio"/> Enable <input checked="" type="radio"/> Disable
Mode	<input checked="" type="radio"/> Total bandwidth <input type="radio"/> Per Rule Bandwidth
Upload	<input type="text"/> kbps
Download	<input type="text"/> kbps

- **Service:** Select **Enable** to turn on bandwidth control through the access point.
- **Mode:** Select the bandwidth control mode to use through the access point.
- **Upload:** Enter **the upload bandwidth speeds**
- **Download:** Enter the download bandwidth speeds

Configure SNMP Setup

SNMP is an application-layer protocol that provides a message format for communication between SNMP managers and agents. By enabling SNMP function, the administrator can obtain the system information remotely.

Please click on **System -> SNMP Setup** and follow the below setting.

SNMP v2c	
Enable	<input type="checkbox"/>
SNMP v3	
Enable	<input checked="" type="checkbox"/>
SNMP Trap	
Enable	<input type="checkbox"/>

- **SNMP v2c Enable:** Check to enable SNMP v2c.

SNMP v2c	
Enable	<input checked="" type="checkbox"/>
ro community	<input type="text"/>
rw community	<input type="text"/>

- **ro community:** Set a community string to authorize read-only access.
- **rw community:** Set a community string to authorize read/write access.

- **SNMP v3 Enable:** Check to enable SNMP v3.

SNMPv3 supports the highest level SNMP security.

SNMP v3	
Enable	<input checked="" type="checkbox"/>
SNMP ro user	<input type="text"/>
SNMP ro password	<input type="text"/>
SNMP rw user	<input type="text"/>
SNMP rw password	<input type="text"/>

- **SNMP ro user:** Set a community string to authorize read-only access.
- **SNMP ro password:** Set a password to authorize read-only access.
- **SNMP rw user:** Set a community string to authorize read/write access.
- **SNMP rw password:** Set a password to authorize read/write access.

- **SNMP Trap:** Events such as cold start, interface up & down, and association & disassociation will report to an assigned server.

SNMP Trap	
Enable	<input checked="" type="checkbox"/>
Community	<input type="text"/>
IP 1	<input type="text"/>
IP 2	<input type="text"/>
IP 3	<input type="text"/>
IP 4	<input type="text"/>

- **Community:** Set a community string required by the remote host computer that will receive trap messages or notices send by the system.
- **IP:** Enter the IP addresses of the remote hosts to receive trap messages. Click **Save** button to save changes and click **Reboot** button to activate.

Configure Time Policy

Configure time policy to apply on settings like access point Radio Schedule.

Policy 1	
Policy	Policy 1 <input type="button" value="Save_Action"/>
Schedule Rule	<input checked="" type="radio"/> On Schedule <input type="radio"/> Out of Schedule
Time Schedule	
Day Of Week	<input type="checkbox"/> Sun <input type="checkbox"/> Mon <input type="checkbox"/> Tue <input type="checkbox"/> Wed <input type="checkbox"/> Thu <input type="checkbox"/> Fri <input type="checkbox"/> Sat
Start From	00 : 00
End At	23 : 59 <input type="button" value="Save"/>

- **Policy:** Select the policy to configure. Click **Save Action** to save settings.
- **Schedule Rule:**
 - **On Schedule:** Select to have policy run on exact schedule
 - **Out of Schedule:** Select to have policy run outside of schedule.
- **Time Schedule:**
 - **Day of week:** Select the days of the week to apply time policy
 - **Start From:** Enter time policy start time

- o **End at:** Enter the end time of time policy

System Status

This section breaks down into subsections of **System Overview**, **Associated Clients Status**, **WDS Link Status**, **Extra Information** and **Event Log**.

System Overview

Display detailed information of **System**, **Network**, **LAN and Wireless** in the System Overview page.

- **Device Information:** Display the information of the system.

Device Information	
Mode	Repeater
Host Name	TEW-738APBO
Host Description	10dBi Outdoor PoE Access Point
Firmware Version	V1.0.19
Firmware Date	2014/04/23 09:44:51
Country	US
System Time	2014/05/05 14:49:12
System Up Time	03:58:31
ETH1 MAC	00:22:AA:00:11:07
ETH2 MAC	00:22:AA:00:11:06
Wireless MAC	00:22:AA:00:11:08

- o **Operating Mode:** The mode currently in service.
- o **Host Name:** The name of the system.
- o **Host Description:** A description of the system.
- o **Firmware Version:** The current installed firmware version.
- o **Firmware Date:** The build time of installed firmware.
- o **Device Time:** The current time of the system.
- o **System Up Time:** The time period that system has been in service since last reboot.
- o **ETH1/ETH2MAC:** Ethernet MAC address of the access point.
- o **Wireless MAC:** Wireless MAC address of the access point

- o **CPU Loading:** The CPU loading of the access point
- o **Memory Used:** Memory usage of the access point.

- **LAN Information:** Display total received and transmitted statistics on the LAN interface.

LAN Information	
Ethernet Connection Type	Static IP
IP Address	192.168.10.100
IP Netmask	255.255.255.0
IP Gateway	192.168.10.1
DNS	

- o **Ethernet Connection Type:** The connection applied on the access point.
- o **IP Address:** The management IP of system. By default, it's 192.168.2.254.
- o **IP Netmask:** The network mask. By default, it's 255.255.255.0.
- o **IP Gateway:** The gateway IP addresses and by default, it's 192.168.2.1.
- o **Primary DNS:** The primary DNS server in service.

- **Wireless Information:** Display total received and transmitted statistics on available Virtual AP.

Wireless Information	
WiFi	On
Band	802.11b/g/n
Channel	5
Current Txpower	28 dBm (630 mW)
Date Rate	Auto (300Mb/s)

- o **WiFi:** Wireless status of the access point.
- o **Band:** Operating wireless band of the access point.
- o **Channel:** Operating channel of the access point.
- o **Current Tx Power:** Transmit power of the access point.

- o **Data Rate:** Current wireless data rate of the access point.

DHCP Client

Display detailed information of the access point's DHCP server.

DHCP Server Status	
Service	Enable
Start IP	192.168.10.101
End IP	192.168.10.254
Default Gateway	192.168.10.100
DNS1	192.168.10.100
DNS2	
WINS	
Domain	
Lease Time	86400

- **Service:** Status of access point's DHCP server
- **Start IP:** Starting IP address of access point's DHCP server
- **End IP:** Last IP address used on the access point's DHCP server
- **Default Gateway:** Assigned gateway address to the access point
- **DNS1/2:** Assigned DNS to the access point's DHCP server
- **WINS:** Assigned WINS to the access point's DHCP server
- **Domain:** Domain assigned to access point
- **Lease Time:** DHCP lease time of access point's DHCP server

DHCP Client List		
IP Address	MAC Address	Expired In
-	-	-

- **DHCP Client list:** List of clients connected to the access point

Extra Information

Users could pull out information such as Route table, ARP table, MAC table, Bridge table or STP available in the drop-down list from system. The "Refresh" button is used to retrieve latest table information.

Extra Information			
Information	Route Information		
Route Information			
Destination	Gateway	Netmask	Interface
192.168.10.0	0.0.0.0	255.255.255.0	bre0
239.0.0.0	0.0.0.0	255.0.0.0	bre0
224.0.0.0	0.0.0.0	224.0.0.0	bre0
0.0.0.0	192.168.10.1	0.0.0.0	bre0

- **Route table information:** Select "Route table information" on the drop-down list to display route table. The access point could be used as a L2 or L3 device. It doesn't support dynamic routing protocols such as RIP or OSPF. Static routes to specific hosts, networks or default gateway are set up automatically according to the IP configuration of system's interfaces. When used as a L2 device, it could switch packets and, as L3 device, it's capable of being a gateway to route packets inward and outward.

Route Information			
Destination	Gateway	Netmask	Interface
192.168.10.0	0.0.0.0	255.255.255.0	bre0
239.0.0.0	0.0.0.0	255.0.0.0	bre0
224.0.0.0	0.0.0.0	224.0.0.0	bre0
0.0.0.0	192.168.10.1	0.0.0.0	bre0

- **ARP table Information:** Select "ARP Table Information" on the drop-down list to display ARP table. ARP associates each IP address to a unique hardware address (MAC) of a device. It is important to have a unique IP address as final destination to switch packets to.

ARP Table Information		
IP Address	MAC Address	Interface
192.168.10.123	00:26:2d:5b:46:53	bre0

- **Bridge table information:** Select “**Bridge Table information**” on the drop-down list to display bridge table. Bridge table will show Bridge ID and STP's Status on the each Ethernet bridge and its attached interfaces, the Bridge Port should be attached to some interfaces (e.g. eth2, ra0~ra6 and wds0~wds3).

Bridge Table Information			
Bridge Port	Bridge ID	STP Enabled	Interface
LAN	8000.0022aa001106	no	eth1
			eth0
			ath0

- **Bridge MAC information:** Select “**Bridge MACs Information**” on the drop-down list to display MAC table.

Bridge MACs Table Information			
Port	MAC Address	Local	Ageing Timer
VAP0	00:14:d1:c2:da:84	no	3.17
LAN	00:22:aa:00:11:06	yes	0.00
WAN	00:22:aa:00:11:07	yes	0.00
VAP0	00:22:aa:00:11:08	yes	0.00
WAN	00:26:2d:5b:46:53	no	0.04

This table displays local MAC addresses associated with wired or wireless interfaces, but also remember non-local MAC addresses learned from wired or wireless interfaces. Ageing timers will be reset when existing MAC addresses in table are learned again or added when new MAC addresses are seen from wired or wireless interfaces as well. When time runs out for a particular entry, it will be pruned from the table. In that situation, switching packet to that particular MAC address will be dropped.

Event Log

The Event log displays system events when system is up and running. Also, it becomes very useful as a troubleshooting tool when issues are experienced in system.

Time	Facility	Severity	Message
2013-07-06 03:32:47	System	Info	Authentication successful for admin from 192.168.10.123

- **Time:** The date and time when the event occurred.
- **Facility:** It helps users to identify source of events such “System” or “User”
- **Severity:** Severity level that a specific event is associated such as “info”, “error”, “warning”, etc.
- **Message:** Description of the event.

Click **Refresh** button to renew the log, or click **Clear** button to clear all the record.

Associated Client List

List of all clients associated to the access point.

#	MAC Address	RSSI	TX/RX Rate	TX/RX SEQ	TX/RX Bytes	Connect Time	Actions
No such device							

- **MAC Address:** Display MAC address of WDS peer.
- **RSSI:** Indicate the signal strength of the respective WDS links.
- **TX/RX SEQ:** Transmit and receive sequence.
- **TX/RX Bytes:** Transmit and receive bytes

Remote AP status

List the current status of the remote access point.

ESSID	MAC Address	Signal/Noise	RSSI	Signal Quality, %	TX/RX Rate	Status
TRENDnet7380_2.4GHz		0 / 0	0	0%	0M / 0M	Unlinked

- **ESSID:** SSID of remote access point
- **MAC Address:** Display MAC address of WDS peer.
- **RSSI:** Indicate the signal strength of the respective WDS links.
- **TX/RX SEQ:** Transmit and receive sequence.
- **TX/RX Bytes:** Transmit and receive bytes
- **Status:** Display current association status of remote access point

CPE + AP Mode Configuration

When CPE+AP mode is chosen, the system can be configured as a Customer Premises Equipment (CPE). This section provides detailed explanation for users to configure in the CPE+AP mode with help of illustrations. In the CPE+AP mode, functions listed in the table below are also available from the Web-based GUI interface.

External Network Connection

Network Requirement

It can be used as an Outdoor Customer Premises Equipment (CPE) to receive and repeat wireless signal over last mile application, helping WISPs deliver wireless broadband Internet service to residents and business customers. In the CPE+AP mode, the access point is a gateway enabled with NAT and DHCP Server functions. The wired and wireless clients connected to the access point are in **different** subnet from those connected to Main Base Station, and, in CPE+AP mode, it **accepts** wireless connections from wireless client devices.

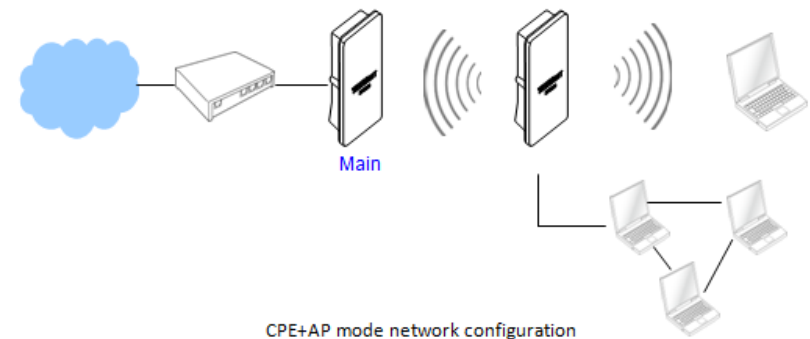

Configure CPE Setup

There are three connection types for the WAN port: **Static IP**, **Dynamic IP**, **PPPoE** and **PPTP**,

Please click on **System** -> **WAN** and follow the below setting.

- **Mode:** Check "Static IP", "Dynamic IP", "PPPoE" or "PPTP" to set up system WAN IP.

Internet Connection Type	
Mode	<div style="border: 1px solid black; padding: 2px;"> Dynamic IP ▼ Static IP Dynamic IP PPPoE PPTP </div>

- **Static IP:** Users can manually setup the WAN IP address with a static IP provided by WISP.
 - **IP Address:** The IP address of the WAN port; default IP address is 192.168.1.254
 - **IP Netmask:** The Subnet mask of the WAN port; default Netmask is 255.255.255.0
 - **IP Gateway :** The default gateway of the WAN port; default Gateway is 192.168.1.1
- **Dynamic IP:** Please consult with WISP for correct wireless settings to associate with WISP AP before a dynamic IP, along with related IP settings including DNS can be available from DHCP server. If IP Address is not assigned, please double check with your wireless settings and ensure successful association. Also, you may go to "**WAN Information**" in the Overview page to click **Release** button to release IP address and click **Renew** button to renew IP address again.

Dynamic IP	
Hostname	<input type="text"/>

- **Hostname :** The Hostname of the WAN port

- **PPPoE :** To create wireless PPPoE WAN connection to a PPPoE server in network.

PPPoE	
Username	<input type="text"/>
Password	<input type="text"/>
Reconnect Mode	<input checked="" type="radio"/> Always On <input type="radio"/> On Demand <input type="radio"/> Manual
Idle Time	<input type="text" value="0"/> Minutes
MTU	<input type="text" value="1492"/>

- **User Name :** Enter User Name for PPPoE connection
- **Password :** Enter Password for PPPoE connection
- **Reconnect Mode:**
 - **Always on:** A connection to Internet is always maintained.
 - **On Demand:** A connection to Internet is made as needed.
 - **Manual:** Click the "**Connect**" button on "**WAN Information**" in the Overview page to connect to the Internet.
- **Idle Time:** Time to last before disconnecting PPPoE session when it is idle. Enter preferred Idle Time in minutes. Default is "0", indicates disabled. When Idle time is disabled, the "**Reconnect Mode**" will turn out "**Always on**"
- **MTU:** By default, it's **1492** bytes. MTU stands for Maximum Transmission Unit. Consult with WISP for a correct MTU setting.

- **PPTP:** The Point-to-Point Tunneling Protocol (PPTP) mode enables the implementation of

secure multi-protocol Virtual Private Networks (VPNs) through public networks.

PPTP	
IP Address	<input type="text"/>
IP Netmask	<input type="text"/>
PPTP Server IP Address	<input type="text"/>
Username	<input type="text"/>
Password	<input type="password"/>
Reconnect Mode	<input checked="" type="radio"/> Always On <input type="radio"/> On Demand <input type="radio"/> Manual
Idle Time	<input type="text" value="0"/> Minutes
MTU	<input type="text" value="1460"/>
MPPE Encryption	<input checked="" type="checkbox"/> MPPE-40 <input type="checkbox"/> MPPE-128

- **IP Address:** The IP address of the WAN port
- **IP Netmask:** The Subnet mask of the WAN port
- **PPTP Server IP Address:** The IP address of the PPTP server
- **User Name :** Enter User Name for PPTP connection
- **Password:** Enter Password for PPTP connection
- **Reconnect Mode:**
 - **Always on:** A connection to Internet is always maintained.
 - **On Demand:** A connection to Internet is made as needed.
 - **Manual:** Click the “**Connect**” button on “**WAN Information**” in the Overview page to connect to the Internet.
- **Idle Time:** Time to last before disconnecting PPPoE session when it is idle. Enter preferred Idle Time in minutes. Default is “**0**”, indicates disabled. When Idle time is disabled, the “**Reconnect Mode**” will turn out “**Always on**”
- **MTU:** By default, it’s **1460** bytes. MTU stands for Maximum Transmission Unit. Consult with WISP for a correct MTU setting.
- **MPPE Encryption:** Microsoft Point-to-Point Encryption (MPPE) encrypts data in Point-to-Point Protocol (PPP)-based dial-up connections or Point-to-Point Tunneling Protocol (PPTP) virtual private network (VPN) connections. **128-bit** key (strong) and **40-bit** key (standard) MPPE encryption schemes are supported. MPPE provides data security for the PPTP connection that is between the VPN client and the VPN server.

- **DNS:** Check “No Default DNS Server” or “Specify DNS Server IP” radial button as desired to set up system DNS.

DNS	
DNS	<input checked="" type="radio"/> No Default DNS Server <input type="radio"/> Specify DNS Server IP
Primary DNS	<input type="text"/>
Secondary DNS	<input type="text"/>

- **Primary:** The IP address of the primary DNS server.
 - **Secondary:** The IP address of the secondary DNS server.
- Click **Save** button to save your changes. Click **Reboot** button to activate your changes

Configure DDNS Setup

Dynamic DNS allows you to map domain name to dynamic IP address. Please click on **System -> DDNS Setup** and follow the below setting.

DDNS	
Service	<input type="radio"/> Enable <input checked="" type="radio"/> Disable
Service Provider	<input type="text" value="dyndns"/>
Hostname	<input type="text"/> - <input type="text"/>
Username	<input type="text"/>
Password	<input type="password"/>

- **Enabled:** By default, it’s “**Disable**”. The mapping domain name won’t change when dynamic IP changes. The beauty of it is no need to remember the dynamic WAP IP while accessing to it.
 - **Service Provider:** Select the preferred Service Provider from the drop-down list including *dyndns*, *dhs*, *ods* and *tzo*
 - **Hostname:** Host Name that you register to Dynamic-DNS service and export.
 - **User Name & Password:** User Name and Password are used to login DDNS service.
- Click **Save** button to save your changes. Click **Reboot** button to activate your changes

Configure LAN IP

Here are the instructions to setup the local IP Address and Netmask.

Please click on **System -> LAN** and follow the below setting.

- **Mode:** Check either “Static IP” or “Dynamic IP” button as desired to set up the system IP of LAN port.

Ethernet Connection Type	
Mode	<input checked="" type="radio"/> Static IP <input type="radio"/> Dynamic IP
Static IP	
IP Address	<input type="text" value="192.168.10.100"/>
IP Netmask	<input type="text" value="255.255.255.0"/>
IP Gateway	<input type="text" value="192.168.10.1"/>

- **Static IP:** The administrator can manually setup the LAN IP address when static IP is available/ preferred.
 - **IP Address:** The IP address of the LAN port; default IP address is 192.168.2.254
 - **IP Netmask:** The Subnet mask of the LAN port; default Netmask is 255.255.255.0
 - **IP Gateway :** The default gateway of the LAN port; default Gateway is 192.168.2.1
- **Dynamic IP:** This configuration type is applicable when the access point is connected to a network with the presence of a DHCP server; all related IP information will be provided by the DHCP server automatically.

Dynamic IP	
Hostname	<input type="text"/>

- **Hostname :** The Hostname of the LAN port
- **DNS:** Check either “No Default DNS Server” or “Specify DNS Server IP” button as desired to set up the system DNS.

DNS	
DNS	<input checked="" type="radio"/> No Default DNS Server <input type="radio"/> Specify DNS Server IP
Primary DNS	<input type="text"/>
Secondary DNS	<input type="text"/>

- **Primary:** The IP address of the primary DNS server.

- **Secondary:** The IP address of the secondary DNS server.

• **802.1d Spanning Tree**

802.1d Spanning Tree	
Service	<input type="radio"/> Enable <input checked="" type="radio"/> Disable

The spanning tree network protocol provides a loop free topology for a bridged LAN between LAN interface and 4 WDS interfaces from wds0 to wds3. The Spanning Tree Protocol, which is also referred to as STP, is defined in the IEEE Standard 802.1d. Spanning tree always disabled on the access point. Below Figures depict a loop for a bridged LAN between LAN and WDS link

- **DHCP Setup:** Devices connected to the system can obtain an IP address automatically when this service is enabled.

DHCP Server	
Service	<input checked="" type="radio"/> Enable <input type="radio"/> Disable
Start IP	<input type="text" value="192.168.10.101"/>
End IP	<input type="text" value="192.168.10.254"/>
Default Gateway	<input type="text" value="192.168.10.100"/>
DNS1 IP	<input type="text" value="192.168.10.100"/>
DNS2 IP	<input type="text"/>
WINS IP	<input type="text"/>
Domain	<input type="text"/>
Lease Time	<input type="text" value="86400"/>

- **DHCP:** Check **Enable** button to activate this function or **Disable** to deactivate this service.
- **Start IP / End IP:** Specify the range of IP addresses to be used by the DHCP server when assigning IP address to clients. The default range IP address is 192.168.2.10 to 192.168.2.70, the netmask is 255.255.255.0
- **DNS1 IP:** Enter IP address of the first DNS server; this field is required.
- **DNS2 IP:** Enter IP address of the second DNS server; this is optional.
- **WINS IP:** Enter IP address of the Windows Internet Name Service (WINS) server; this is optional.
- **Domain:** Enter the domain name for this network.

- **Lease Time:** The IP addresses given out by the DHCP server will only be valid for the duration specified by the lease time. Increasing the time ensure client operation without interruptions, but could introduce potential conflicts. Lowering the lease time will avoid potential address conflicts, but might cause more interruptions to the client while it will acquire new IP addresses from the DHCP server. Default is **86400** seconds

Click **Save** button to save your changes. Click **Reboot** button to activate your changes

Configure Static IP address

Assign static IP address to associated clients through the access point.

Static Lease IP	
Comment	<input type="text"/>
IP Address	<input type="text" value="192.168.10."/>
MAC Address	<input type="text"/> <input type="button" value="Add"/>

- **Comment:** Enter a note of assigned IP address
- **IP Address:** Enter the IP address to assign
- **MAC address:** Enter the client MAC address to the assigned IP address. Click Add to enter settings.

Access Point Association

Wireless General Setup

The administrator can change the data transmission, channel and output power settings for the system. Please click on **Wireless -> General Setup** and follow the below setting.

General Setup	
MAC Address	00:22:aa:00:11:08
Band Mode	802.11b/g/n <input type="button" value="v"/>
Channel	Auto <input type="button" value="v"/> <input type="button" value="Auto Scan"/>
Tx Power	Level 9 <input type="button" value="v"/>
RF(ON/OFF) Schedule	Always Run <input type="button" value="v"/>

- **MAC Address:** The MAC address of the Wireless interface is displayed here.
- **Band Mode:** Select an appropriate wireless band; bands available are 801.11b, 802.11b/g, 802.11b/g/n or 802.11n only.
- **Channel:** Select the desired channel from the drop-down list to have the access point operate on. Click **Auto Scan** to scan for the best available channel to use based on the environment.
- **Tx Power:** You can adjust the output power of the system to get the appropriate coverage for your wireless network. Specify digit numbers between 1 to 100 (the unit is %) for your environment. If you are not sure which setting to choose, then keep the default setting, **100%**.
- **RF (ON/OFF) Schedule:** Select an assigned schedule of when to have the access point turn on. Select **Always Run** to have the access point always on.

When **Band Mode** select in **802.11a only mode**, the **HT(High Throughput)** settings should be hidden immediately.

HT Physical Mode	
TX/RX Stream	<input type="radio"/> 1 <input checked="" type="radio"/> 2
Channel BandWidth	<input type="radio"/> 20 <input checked="" type="radio"/> 20/40
Extension Channel	<input type="radio"/> Upper <input checked="" type="radio"/> Lower
MCS	Auto ▾
Short GI	<input type="radio"/> Disbale <input checked="" type="radio"/> Enable
Aggregation	<input type="radio"/> Disable <input checked="" type="radio"/> Enable
Aggregation Frames	<input type="text" value="32"/>
Aggregation Size	<input type="text" value="50000"/>

- **TxStream/Rx Stream:** Select the amount of transmit (TX) and Receive (RX) streams. By default, it's 2.
- **Channel Bandwidth:** The "20/40" MHz option is usually best. The other option is available for special circumstances.
- **Extensions Channel:** Select which section of channels to use for extension channels.
- **MCS:** This parameter represents transmission rate. By default (Auto) the fastest possible transmission rate will be selected. You have the option of selecting the speed if necessary. (Refer to **Appendix C. MCS Data Rate**)

Wireless Advanced Setup

To achieve optimal wireless performance, it is necessary to tweak advance setting per requirements properly, not necessary higher the better or lower.

The administrator can change the RTS threshold and fragmentation threshold settings for the system. Please click on **Wireless -> Advanced Setup** and follow the below setting.

Advanced Setup	
Slot Time	<input type="text" value="9"/> <input type="text" value="Distance"/>
ACK Timeout	<input type="text" value="64"/>
Beacon Interval	<input type="text" value="100"/>
DTIM Interval	<input type="text" value="1"/>
RTS Threshlod	<input type="text" value="2346"/>
Short Preamble	<input checked="" type="radio"/> Enable <input type="radio"/> Disable
IGMP Snooping	<input type="radio"/> Enable <input checked="" type="radio"/> Disable
Greenfield	<input checked="" type="radio"/> Enable <input type="radio"/> Disable
WMM	<input checked="" type="radio"/> Enable <input type="radio"/> Disable

- **Short Slot :** By default, it's "**Enable**" for reducing the slot time from the standard **20 microseconds** to the **9 microsecond** short slot time. Slot time is the amount of time a device waits after a collision before retransmitting a packet. Reducing the slot time decreases the overall back-off, which increases throughput. Back-off, which is a multiple of the slot time, is the random length of time a station waits before sending a packet on the LAN. For a sender and receiver own right of the channel the shorter slot time help manage shorter wait time to re-transmit from collision because of hidden wireless clients or other causes. When collision sources can be removed sooner and other senders attempting to send are listening the channel(CSMA/CA) the owner of the channel should continue ownership and finish their transmission and release the channel. Then, following ownership of the channel will be sooner for the new pair due to shorter slot time. However, when long duration of existing collision sources and shorter slot time exist the owners might experience subsequent collisions. When adjustment to longer slot time can't improve performance then RTS/CTS could supplement and help improve performance.
- **ACK Timeout:** ACK timeout is in the range of **1~255** and set in unit of **microsecond**. The default value is **32** microsecond. All data transmission in 802.11b/g request an "Acknowledgement" (ACK) send by receiving radio. The transmitter will resend the original packet if correspondent ACK failed to arrive within specific time interval, also refer to as "ACK Timeout".

ACK Timeout is adjustable due to the fact that distance between two radio links may vary in different deployment. ACK Timeout makes significant influence in

performance of long distance radio link. If ACK Timeout is set too short, transmitter will start to "Resend" packet before ACK is received, and throughputs become low due to excessively high re-transmission. ACK Timeout is best determined by distance between the radios, data rate of average environment. The Timeout value is calculated based on round-trip time of packet with a little tolerance, So, if experiencing re-transmissions or poor performance the ACK Timeout could be made longer to accommodate.

- **Beacon Interval::** Beacon Interval is in the range of **20~1024** and set in unit of *millisecond*. The default value is **100 msec**.

Access Point (AP) in IEEE 802.11 will send out a special approximated 50-byte frame, called "Beacon". Beacon is broadcast to all the stations, provides the basic information of AP such as SSID, channel, encryption keys, signal strength, time stamp, support data rate.

All the radio stations received beacon recognizes the existence of such AP, and may proceed next actions if the information from AP matches the requirement. Beacon is sent on a periodic basis, the time interval can be adjusted.

By increasing the beacon interval, you can reduce the number of beacons and associated overhead, but that will likely delay the association and roaming process because stations scanning for available access points may miss the beacons. You can decrease the beacon interval, which increases the rate of beacons. This will make the association and roaming process very responsive; however, the network will incur additional overhead and throughput will go down.

- **DTIM Interval:** The DTIM interval is in the range of **1~255**. The default is **1**.
DTIM is defined as *Delivery Traffic Indication Message*. It is used to notify the wireless stations, which support power saving mode, when to wake up to receive multicast frame. DTIM is necessary and critical in wireless environment as a mechanism to fulfill power-saving synchronization. A DTIM interval is a count of the number of beacon frames that must occur before the access point sends the buffered multicast frames. For instance, if DTIM Interval is set to 3, then the Wi-Fi clients will expect to receive a multicast frame after receiving three Beacon frame. The higher DTIM interval will help power saving and possibly decrease wireless throughput in multicast applications.
- **RTS Threshold:** TRTS Threshold is in the range of **1~2347** byte. The default is **2347** byte. The main purpose of enabling RTS by changing RTS threshold is to reduce possible collisions due to hidden wireless clients. RTS in AP will be enabled automatically if the packet size is larger than the Threshold value. By default, RTS is disabled in a normal environment supports non-jumbo frames.

- **Short Preamble:** By default, it's "**Enable**". To **Disable** is to use Long 128-bit Preamble Synchronization field. The preamble is used to signal "here is a train of data coming" to the receiver. The short preamble provides 72-bit Synchronization field to improve WLAN transmission efficiency with less overhead.
- **WMM:** By default, it's "**Enabled**".

Wireless WMM QoS Setup

To achieve optimal wireless performance, it is necessary to tweak advance setting per requirements properly, not necessary higher the better or lower. The administrator can change the RTS threshold and fragmentation threshold settings for the system. Please click on **Wireless -> Advanced**

WMM QoS					
WMM Parameters of Access Point					
AC Type	CWmin	CWmax	AIFS	TxOp Limit	No ACK Policy bit
AC_BE(0)	4	6	3	0	<input type="checkbox"/>
AC_BK(1)	4	10	7	0	<input type="checkbox"/>
AC_VI(2)	3	4	1	3008	<input type="checkbox"/>
AC_VO(3)	2	3	1	1504	<input type="checkbox"/>

WMM Parameters of Station					
AC Type	CWmin	CWmax	AIFS	TxOp Limit	ACM bit
AC_BE(0)	4	10	3	0	<input type="checkbox"/>
AC_BK(1)	4	10	7	0	<input type="checkbox"/>
AC_VI(2)	3	4	2	3008	<input type="checkbox"/>
AC_VO(3)	2	3	2	1504	<input type="checkbox"/>

- **WMM Parameters of Access Point :** *This affects traffic flowing from the access point to the client station*

Queue	Data Transmitted AP to Clients	Priority	Description
AC_BK	Background.	Low	High throughput. Bulk data that requires maximum throughput and is not time-sensitive is sent to this queue (FTP data, for example).

Queue	Data Transmitted Clients to AP	Priority	Description
AC_BK	Background.	Low	High throughput. Bulk data that requires maximum throughput and is not time-sensitive is sent to this queue (FTP data, for example).
AC_BE	Best Effort	Medium	Medium throughput and delay. Most traditional IP data is sent to this queue
AC_VI	Video	High	Minimum delay. Time-sensitive video data is automatically sent to this queue
AC_VO	Voice	High	Time-sensitive data like VoIP and streaming media are automatically sent to this queue
AC_BE	Best Effort	Medium	Medium throughput and delay. Most traditional IP data is sent to this queue
AC_VI	Video	High	Minimum delay. Time-sensitive video data is automatically sent to this queue
AC_VO	Voice	High	Time-sensitive data like VoIP and streaming media are automatically sent to this queue

Configuring QoS options consists of setting parameters on existing queues for different types of wireless traffic. You can configure different minimum and maximum wait times for the transmission of packets in each queue based on the requirements of the media being sent. Queues automatically provide minimum transmission delay for Voice, Video, multimedia, and mission critical applications, and rely on best-effort parameters for traditional IP data.

As an Example, time-sensitive Voice & Video, and multimedia are given effectively higher priority for transmission (lower wait times for channel access), while other applications and traditional IP data which are less time-sensitive but often more data-intensive are expected to tolerate longer wait times.

- **Aifsn:** The Arbitration Inter-Frame Spacing Number specifies a wait time (in milliseconds) for data frames
- **CWmin:** Minimum Contention Window. This parameter is input to the algorithm that determines the initial random back-off wait time ("window") for retry of a transmission. The value specified here in the Minimum Contention Window is the upper limit (in milliseconds) of a range from which the initial random back-off wait time is determined.
- **CWmax:** Maximum Contention Window. The value specified here in the Maximum Contention Window is the upper limit (in milliseconds) for the doubling of the random back-off value. This doubling continues until either the data frame is sent or the Maximum Contention Window size is reached. Once the Maximum Contention Window size is reached, retries will continue until a maximum number of retries allowed is reached. Valid values for the "cwmax" are 1, 3, 7, 15, 31, 63, 127, 255, 511, or 1024. The value for "cwmax" must be higher than the value for "cwmin".
- **Txop:** Transmission Opportunity is an interval of time when a WME AP has the right to initiate transmissions onto the wireless medium (WM). This value specifies (in milliseconds) the Transmission Opportunity (TXOP) for AP; that is, the interval of time when the WMM AP has the right to initiate transmissions on the wireless network.
- **ACM:** Admission Control Mandatory, ACM only takes effect on AC_VI and AC_VO. When you do not click Checkbox, it means that the ACM is controlled by the connecting AP. If you click Checkbox, it means that the Client is in charge.
- **AckPolicy:** Acknowledgment Policy, WMM defines two ACK policies: **Normal ACK** and **No ACK**. Click "**Checkbox**" indicates "**No ACK**"

When the no acknowledgment (No ACK) policy is used, the recipient does not acknowledge received packets during wireless packet exchange. This policy is suitable in the environment where communication quality is fine and interference is weak. While the No ACK policy helps improve transmission efficiency, it can cause increased packet loss when communication quality deteriorates. This is because when this policy is used, a sender does not retransmit packets that have not been received by the recipient. When the Normal ACK policy is used, the recipient acknowledges each received unicast packet.

- **WMM Parameters of Station:** *This affects traffic flowing from the client station to the access point.*
 - **Aifsn** : The Arbitration Inter-Frame Spacing Number specifies a wait time (in milliseconds) for data frames
 - **CWmin** : Minimum Contention Window. This parameter is input to the algorithm that determines the initial random backoff wait time ("window") for retry of a transmission. The value specified here in the Minimum Contention Window is the upper limit (in milliseconds) of a range from which the initial random backoff wait time is determined.
 - **CWmax** : Maximum Contention Window. The value specified here in the Maximum Contention Window is the upper limit (in milliseconds) for the doubling of the random backoff value. This doubling continues until either the data frame is sent or the Maximum Contention Window size is reached. Once the Maximum Contention Window size is reached, retries will continue until a maximum number of retries allowed is reached. Valid values for the "cwmax" are 1, 3, 7, 15, 31, 63, 127, 255, 511, or 1024. The value for "cwmax" must be higher than the value for "cwmin".
 - **Txop** : Transmission Opportunity is an interval of time when a WME AP has the right to initiate transmissions onto the wireless medium (WM). This value specifies (in milliseconds) the Transmission Opportunity (Txop) for AP; that is, the interval of time when the WMM AP has the right to initiate transmissions on the wireless network.
 - **ACM**: Admission Control Mandatory, ACM only takes effect on AC_VI and AC_VO. When you do not click Checkbox, it means that the ACM is controlled by the connecting AP. If you click Checkbox, it means that the Client is in charge.

Click **Save** button to save your changes. Click **Reboot** button to activate your changes. The items in this page are for AP's RF advanced settings and will be applied to **all VAPs** and **WDS Links**.

Site Survey

Use this tool to scan and locate WISP Access Points and select one to associate with. Please click on **Wireless -> Site Survey**. Below depicts an example for site survey.

ESSID	MAC Address	Signal/Noise, dBm	RSSI	Signal Quality, %	Channel	Security	Select
WalkingDead	00:E0:4C:81:86:82	-29 / -95	66	100%	1	WPA2-PSK/AES	Select
TRENDnet639RMA	D8:EB:97:A5:90:EC	-41 / -95	54	100%	1	WPA-PSK/AES	Select
TrendnetSkyN	00:14:D1:C5:7D:44	-69 / -95	26	76%	1	WPA2-PSK/AES	Select
TRENDnet815_2.4GHz_3272	00:11:E0:04:96:AD	-30 / -95	65	100%	1	WPA2-PSK/AES	Select
ATT048	90:B1:34:B0:53:60	-79 / -95	16	42%	1	WPA-PSK/AES	Select
V72	D8:EB:97:BC:18:EC	-62 / -95	33	92%	1	WPA2-PSK/AES	Select
TRENDnet752_2.4GHz_0019	D0:AE:EC:C4:E3:C0	-32 / -95	63	100%	7	WPA2-PSK/AES	Select
TrendnetSkyN	00:14:D1:CF:3F:0C	-48 / -95	47	100%	11	WPA2-PSK/AES	Select

- **ESSID:** Available Extend Service Set ID of surrounding Access Points.
- **MAC Address:** MAC addresses of surrounding Access Points.
- **Signal:** Received signal strength of all found Access Points.
- **Channel:** Channel numbers used by all found Access Points.
- **Security:** Security type by all found Access Points.
- **Band:** Wireless band used by all found Access Points.
- **Network Type:** Network type used by all found Access Points.
- **Select:** Click "Select" to configure settings and associate with chosen AP.

Create Wireless Profile

The administrator can configure station profiles via this page. Please click on **Wireless -> Wireless Profile** and follow the below setting.

- **Connection Setup:** Select the repeater connection type.

Connection Setup

Connection Setup Fix Cycle

- **Fix:** Select to have access point fixed on one profile to repeat
- **Cycle:** Select to have access point cycle through different profiles.

- **General Configuration:**

General Configuration	
MAC Address	00:22:AA:00:11:08
Profile Name	<input type="text"/>
ESSID	<input type="text"/>
Lock to AP MAC	<input type="text"/> (Optional)
Security Type	NONE

- **MAC Address:** The MAC address of the Wireless Station is displayed here.
- **Profile Name:** Set different profiles for quick connection uses.
- **ESSID:** Assign Service Set ID for the wireless system.
- **Lock to AP MAC:** This allows the station to always maintain connection to a particular AP with a specific MAC address. This is useful as sometimes there can be few identically named SSID's (AP's) with different MAC addresses. With AP lock on, the station will lock to MAC address and not roam between several Access Points with the same ESSID.
- **Security Type:** Select the desired security type from the drop-down list; the options are **Disable**, **WEP**, **WPA-PSK**, **WPA2-PSK**, **WPA-Enterprise**, **WPA2-Enterprise** and **WEP 802.1X**.
 - **Disable:** Data are unencrypted during transmission when this option is selected.

WEP	
Key Length	64 bits
WEP Auth Method	<input checked="" type="checkbox"/> Open System <input type="checkbox"/> Shared
Key Index	1
WEP Key 1	<input type="text"/>
WEP Key 2	<input type="text"/>
WEP Key 3	<input type="text"/>
WEP Key 4	<input type="text"/>

- **WEP Auth Method:** Enable the desire option among **OPEN** or **SHARED**
 - Key Index: Key index is used to designate the WEP key during data transmission. 4 different WEP keys can be entered at the same time, but only one is chosen.
 - **WEP Key #:** Enter **HEX** or **ASCII** format WEP key value; the system supports up to

4 sets of WEP keys.

- **WPA-PSK (or WPA2-PSK) :** WPA (or WPA2) Algorithms, allows the system accessing the network by using the WPA-PSK protected access.

WPA General	
Cipher Suite	<input checked="" type="radio"/> AES <input type="radio"/> TKIP
Group Key Update Period	600
Master Key Update Period	83400
Key Type	<input checked="" type="radio"/> ASCII <input type="radio"/> HEX
Pre-shared Key	<input type="text"/>

- **Cipher Suite:** By default, it is **AES**. Select either AES or TKIP cipher suites
- **Group Key Update Period:** By default, it is **600** seconds. This time interval for rekeying GTK, broadcast/multicast encryption keys, in seconds. Entering the time-length is required.
- **Master Key Update Period:** By default, it is **83499** seconds. This time interval for rekeying GTK, broadcast/multicast encryption keys, in seconds. Entering the time-length is required.
- **Pre-shared Key:** Enter the pre-shared key; the format shall go with the selected key type.
- **WPA-Enterprise (or WPA2-Enterprise):** The RADIUS authentication and encryption will be both enabled if this is selected.

WPA General	
Cipher Suite	<input checked="" type="radio"/> AES <input type="radio"/> TKIP
Group Key Update Period	<input type="text" value="600"/>
Master Key Update Period	<input type="text" value="83400"/>
EAP Reauth Period	<input type="text" value="3600"/>
Authentication RADIUS Server	
Server IP	<input type="text"/>
Port	<input type="text" value="1812"/>
Shared Secret	<input type="text"/>
Accounting RADIUS Server	<input checked="" type="radio"/> Enable <input type="radio"/> Disable

- **WPA General Settings:**

- **Cipher Suite:** By default, it is AES. Select either AES or TKIP cipher suites
- **Group Key Update Period:** By default, it's **3600** seconds. This time interval for rekeying GTK, broadcast/multicast encryption keys, in seconds. Entering the time-length is required.
- **Master Key Update Period:** By default, it is **83499** seconds. This time interval for rekeying GTK, broadcast/multicast encryption keys, in seconds. Entering the time-length is required.
- **EAP Reauth Period:** By default, it's **3600** seconds. Set **WPA2** PMKID cache timeout period, after time out, the cached key will be deleted.
- **Pre-Authentication:** By default, it's "Disable". To Enable is use to speed up roaming before pre-authenticating IEEE 802.1X/EAP part of the full RSN authentication and key handshake before actually associating with a new AP.

- **Radius Server Settings :**

- **IP Address:** Enter the IP address of the Authentication RADIUS server.
- **Port:** By default, it's 1812. The port number used to communicate with RADIUS server.
- **Shared secret:** A secret key used between system and RADIUS server. Supports 8 to 64 characters.
- **Accounting RADIUS Server:** Enable to set Account RADIUS server.
- **WEP 802.1X:** When WEP 802.1x Authentication is enabled, please refer to the following Dynamic WEP and RADIUS settings to complete configuration.

Dynamic WEP Setting	
WEP Key Length	<input checked="" type="radio"/> 64bits <input type="radio"/> 128bits
WEP Key Update Period	<input type="text" value="300"/>
EAP Reauth Period	<input type="text" value="3600"/>
Authentication RADIUS Server	
Server IP	<input type="text"/>
Port	<input type="text" value="1812"/>
Shared Secret	<input type="text"/>
Accounting RADIUS Server	<input checked="" type="radio"/> Enable <input type="radio"/> Disable

- **Radius Server Settings:**

- **IP Address:** Enter the IP address of the Authentication RADIUS server.
- **Port:** By default, it's **1812**. The port number used to communicate with RADIUS server.
- **Shared secret:** A secret key used between system and RADIUS server. Supports **8** to **64** characters.
- **Accounting RADIUS Server:** Enable to set Account RADIUS server.
- **Key Index:** key index is used to designate the WEP key during data transmission. 4 different WEP keys can be entered at the same time, but only one is chosen.
- **WEP Key #:** Enter **HEX** or **ASCII** format WEP key value; the system supports up to 4 sets of WEP keys.
- **WPA-PSK (or WPA2-PSK):** WPA (or WPA2) Algorithms, allows the system accessing the network by using the WPA-PSK protected access.

AP Setup

The administrator can configure station profiles via this page. Please click on **Wireless -> Wireless Profile** and follow the below setting.

Security	
ESSID	Repeater AP
Enable Repeater AP	<input type="radio"/> Enable <input checked="" type="radio"/> Disable
Hidden SSID	<input type="radio"/> Enable <input checked="" type="radio"/> Disable
Client Isolation	<input type="radio"/> Enable <input checked="" type="radio"/> Disable
IAPP	<input type="radio"/> Enable <input checked="" type="radio"/> Disable
Maximum Clients	32
Security Type	Disable

- **ESSID:** Assign Service Set ID for the wireless system.
- **Enable Repeater SSID:** Select **Enable** to broadcast the repeated signal.
- **Hidden SSID:** Select **Enable** to broadcast the access point's SSID.
- **Client Isolation:** Select **Enable** to isolate wireless clients from each other.
- **IAPP:**
- **Maximum Clients:** Enter the amount of wireless clients allowed to connect to the access point.
- **Security Type:** Select the desired security type from the drop-down list; the options are **Disable**, **WEP**, **WPA-PSK**, **WPA2-PSK**, **WPA-Enterprise**, **WPA2-Enterprise** and **WEP 802.1X**.
 - **Disable:** Data are unencrypted during transmission when this option is selected.

WEP	
Key Length	64 bits
WEP Auth Method	<input checked="" type="checkbox"/> Open System <input type="checkbox"/> Shared
Key Index	1
WEP Key 1	
WEP Key 2	
WEP Key 3	
WEP Key 4	

- **WEP Auth Method:** Enable the desire option among **OPEN** or **SHARED**
 - Key Index: Key index is used to designate the WEP key during data transmission.

- 4 different WEP keys can be entered at the same time, but only one is chosen.
- **WEP Key #:** Enter **HEX** or **ASCII** format WEP key value; the system supports up to 4 sets of WEP keys.
- **WPA-PSK (or WPA2-PSK) :** WPA (or WPA2) Algorithms, allows the system accessing the network by using the WPA-PSK protected access.

WPA General	
Cipher Suite	<input type="radio"/> AES <input checked="" type="radio"/> TKIP
Group Key Update Period	600
Master Key Update Period	83400
Key Type	<input checked="" type="radio"/> ASCII <input type="radio"/> HEX
Pre-shared Key	

- **Cipher Suite:** By default, it is **AES**. Select either AES or TKIP cipher suites
- **Group Key Update Period:** By default, it is **600** seconds. This time interval for rekeying GTK, broadcast/multicast encryption keys, in seconds. Entering the time-length is required.
- **Master Key Update Period:** By default, it is **83499** seconds. This time interval for rekeying GTK, broadcast/multicast encryption keys, in seconds. Entering the time-length is required.
- **Pre-shared Key:** Enter the pre-shared key; the format shall go with the selected key type.
- **WPA-Enterprise (or WPA2-Enterprise):** The RADIUS authentication and encryption will be both enabled if this is selected.

WPA General	
Cipher Suite	<input type="radio"/> AES <input type="radio"/> TKIP
Group Key Update Period	<input type="text" value="600"/>
Master Key Update Period	<input type="text" value="83400"/>
EAP Reauth Period	<input type="text" value="3600"/>
Authentication RADIUS Server	
Server IP	<input type="text"/>
Port	<input type="text" value="1812"/>
Shared Secret	<input type="text"/>
Accounting RADIUS Server	<input type="radio"/> Enable <input type="radio"/> Disable

- **WPA General Settings:**
 - **Cipher Suite:** By default, it is AES. Select either AES or TKIP cipher suites
 - **Group Key Update Period:** By default, it's **3600** seconds. This time interval for rekeying GTK, broadcast/multicast encryption keys, in seconds. Entering the time-length is required.
 - **Master Key Update Period:** By default, it is **83499** seconds. This time interval for rekeying GTK, broadcast/multicast encryption keys, in seconds. Entering the time-length is required.
 - **EAP Reauth Period:** By default, it's **3600** seconds. Set **WPA2** PMKID cache timeout period, after time out, the cached key will be deleted.
 - **Pre-Authentication:** By default, it's "Disable". To Enable is use to speed up roaming before pre-authenticating IEEE 802.1X/EAP part of the full RSN authentication and key handshake before actually associating with a new AP.
- **Radius Server Settings :**
 - **IP Address:** Enter the IP address of the Authentication RADIUS server.
 - **Port:** By default, it's 1812. The port number used to communicate with RADIUS server.
 - **Shared secret:** A secret key used between system and RADIUS server. Supports 8 to 64 characters.
 - **Accounting RADIUS Server:** Enable to set Account RADIUS server.
- **WEP 802.1X:** When WEP 802.1x Authentication is enabled, please refer to the

following Dynamic WEP and RADIUS settings to complete configuration.

Dynamic WEP Setting	
WEP Key Length	<input type="radio"/> 64bits <input checked="" type="radio"/> 128bits
WEP Key Update Period	<input type="text" value="300"/>
EAP Reauth Period	<input type="text" value="3600"/>
Authentication RADIUS Server	
Server IP	<input type="text"/>
Port	<input type="text" value="1812"/>
Shared Secret	<input type="text"/>
Accounting RADIUS Server	<input type="radio"/> Enable <input type="radio"/> Disable

- **Radius Server Settings:**
 - **IP Address:** Enter the IP address of the Authentication RADIUS server.
 - **Port:** By default, it's **1812**. The port number used to communicate with RADIUS server.
 - **Shared secret:** A secret key used between system and RADIUS server. Supports **8** to **64** characters.
 - **Accounting RADIUS Server:** Enable to set Account RADIUS server.
 - **Key Index :** key index is used to designate the WEP key during data transmission. 4 different WEP keys can be entered at the same time, but only one is chosen.
 - **WEP Key # :** Enter **HEX** or **ASCII** format WEP key value; the system supports up to 4 sets of WEP keys.
 - **WPA-PSK (or WPA2-PSK) :** WPA (or WPA2) Algorithms, allows the system accessing the network by using the WPA-PSK protected access.

Wireless AP MAC Filter Setup

The administrator can allow or reject clients to access Repeater AP.

MAC Rules	
Action	Disable <input type="button" value="Save"/>
ACL MAC Address	
MAC Address	<input type="text"/> <input type="button" value="Add"/>

- **MAC Filter Setup:** By default, it's "**Disable**". Options are **Disable**, **Only Deny List** or **Only Allow List MAC**.
- **MAC or Only Allow List MAC.**
Two ways to set MAC filter rules:
 - **Only Allow List MAC:** The wireless clients in the "**Enable**" list will be **allowed** to access the Access Point; All others or clients in the "**Disable**" list will be **denied**.
 - **Only Deny List MAC:** The wireless clients in the "**Enable**" list will be **denied** to access the Access Point; All others or clients in the "**Disable**" list will be **allowed**.
- **MAC:** Enter MAC address (e.g. aa:bb:cc:00:00:0a) and click "**Add**" button, then the MAC address should display in the "**Enable**" List.

There are a maximum of **20** clients allowed in this "Enable" List. The MAC addresses of the wireless clients can be added and removed to the list using the **Add** and **Remove** buttons. Click **Apply** button to activate your changes

Access Control

DMZ

DMZ is commonly work with the NAT functionality as an alternative of Virtual Server(Port Forwarding) while wanting all ports of DMZ host visible to Internet users. Virtual Server rules have precedence over the DMZ rule. In order to use a range of ports available to access to different internal hosts Virtual Server rules are needed.

DMZ	
Service	Automatic Assignment <input type="button" value="Save"/>
Internal IP Address	<input type="text"/>

- **DMZ:** By default, it's "**Disable**". Check **Enable** radial button to enable DMZ.
 - **IP Address:** Enter IP address of DMZ host and only one DMZ host is supported.
- Click **Save** button to save your changes. Click **Reboot** button to activate your changes.

IP Filter Setup

Allows to create deny or allow rules to filter ingress or egress packets from specific source and/or to destination IP address on wired (LAN) or Wireless (WAN) ports. Filter rules could be used to filter unicast or multicast packets on different protocols as shown in the IP Filter Setup. Important to note that IP filter rules has precedence over Virtual server rules.

Please click on **Advance -> IP Filter Setup** and follow the below setting.

IP Rules	
Source Address/Mask	<input type="text"/>
Source Port	<input type="text"/>
Destination Address/Mask	<input type="text"/>
Destination Port	<input type="text"/>
In/Out	<input checked="" type="radio"/> In <input type="radio"/> Out
Protocol	ALL <input type="button" value="Save"/>
Policy	<input checked="" type="radio"/> Deny <input type="radio"/> Pass
Interface	ALL <input type="button" value="Save"/>
Schedule	Always Run <input type="button" value="Save"/>

- **Source Address/Mask:** Enter desired source IP address and netmask; i.e. 192.168.2.10/32.
- **Source Port:** Enter a port or a range of ports as **start:end**; i.e. port 20:80
- **Destination Address/Mask:** Enter desired destination IP address and netmask; i.e. 192.168.1.10/32
- **Destination Port:** Enter a port or a range of ports as **start:end**; i.e. port 20:80
- **In/Out:** Applies to Ingress or egress packets
- **Protocol:** Supports **TCP**, **UDP** or **ICMP**.
- **Listen:** Click **Yes** radial button to match TCP packets only with the SYN flag.
- **Active:** **Deny** to drop and **Pass** to allow per filter rules
- **Interface:** The interface that a filter rule applies

Click **"Save"** button to add IP filter rule. Total of **20** rules maximum allowed in the IP Filter List. All rules can be edited or removed from the List. Click **Reboot** button to activate your changes.

When you create rules in the IP Filter List, the prior rules maintain higher priority. To allow limited access from a subnet to a destination network manager needs to create allow rules first and followed by deny rules. So, if you just want one IP address to access the system via telnet from your subnet, not others, the Example 1 demonstrates it, not rules in the Example 2.

- **Example 1** : Create a higher priority rule to allow IP address 192.168.2.2 Telnet access from LAN port first, and deny Telnet access from remaining IP addresses in the same subnet.
- **Example 2** : All Telnet access to the system from the IP addresses of subnet 192.168.2.x works with the rule 1 of Example 2. The rule 2 won't make any difference.

MAC Filter Setup

Create MAC filter rules to allow or deny unicast or multicast packets from limited number of MAC addresses. Note that MAC filter rules have precedence over IP Filter rules.

Please click on **Advance -> MAC Filter Setup** and follow the below setting.

Action	
Service	Disable ▾
MAC Address	
MAC Address	<input type="text"/> <input type="button" value="Add"/>
Schedule	Always Run ▾

- **MAC Filter Rule:** By default, it's **"Disable"**. Options are **Disabled, Only Deny List MAC** or **Only Allow List MAC**. Click **Save** button to save your change.
Two ways to set the MAC Filter List:
 - **Only Allow List MAC:** The wireless clients in the MAC Filter List will be **allowed** to access to Access Point; All others will be denied.

- **Only Deny List MAC:** The wireless clients in the MAC Filter List will be **denied** to access to Access Point; All others will be allowed.
- **MAC Address:** Enter MAC address (e.g. aa:bb:cc:00:00:0a) and click **"Add"** button, then the MAC address should display in the MAC Filter List.

There are a maximum of **20** clients allowed in this MAC Filter List. The MAC addresses of the wireless clients can be added and removed to the list using the **Add** and **Delete** buttons.

Click **Reboot** button to activate your changes

Virtual Server

"Virtual Server" can also referred to as "Port Forward" as well and used interchangeably. Resources in the network can be exposed to the Internet users in a controlled manner including on-line gaming, video conferencing or others via Virtual Server setup. Don't repeat ports' usage to avoid confusion.

Suppose you want to assign ports 21-25 to one FTP, Telnet and SMTP server (A in the example), and port 80 to another (B in the example). You assign the LAN IP addresses and the ISP assigns the WAN IP address. The NAT network appears as a single host on the Internet.

Virtual Server	
Service	<input checked="" type="radio"/> Enabled <input type="radio"/> Disabled
Description	<input type="text"/>
Private IP	<input type="text"/>
Protocol Type	<input checked="" type="radio"/> TCP <input type="radio"/> UDP
Private Port	<input type="text"/>
Public Port	<input type="text"/>
Schedule	Always Run ▾

- **Virtual Server:** By Default, It's **"Disable"**. Check **Enable** radial button to enable Virtual Server.
- **Description:** Enter appropriate message for resource sharing via Virtual Server.
- **Private IP:** Enter corresponding IP address of internal resource to share.
- **Protocol Type:** Select appropriate sessions, TCP or UDP, from shared host via multiple private ports.

- **Private Port:** A port or a range of ports may be specified as **start:end**; i.e. port 20:80
 - **Public Port:** A port or a range of ports may be specified as **start:end**; i.e. port 20:80
- .Click **“Add”** button to add Virtual Server rule to List. Total of maximum **20** rules are allowed in this List. All rules can be edited or removed from the List. Click **Reboot** button to activate your changes.

While creating multiple Virtual Server rules, the prior rules have higher priority. The Virtual server rules have precedence over the DMZ one while both rules exist. Example 1 and 2 demonstrate proper usage of DMZ and Virtual Server rules.

- **Example 1:** All connections should be redirected to **192.168.2.12** while DMZ is enabled. Since Virtual Server rules have precedence over the DMZ rule all connections to TCP port 22 will be directed to TCP port 22 of 192.168.2.10 and remaining connections to port TCP **20~80** will be redirected to port TCP **20~80** of **192.168.2.11**
- **Example 2:** All connections should be redirected to **192.168.2.12** while DMZ is enabled. Since Virtual Server rules have precedence over the DMZ rule all other connections to TCP port **20~80** will be redirected to port **20~80** of **192.168.2.11**. The rule 2 won't take effect.

Bandwidth Control

Bandwidth control allows you to control the bandwidth going through the access point.

Bandwidth Control	
Service	<input type="radio"/> Enable <input checked="" type="radio"/> Disable
Mode	<input checked="" type="radio"/> Total bandwidth <input type="radio"/> Per Rule Bandwidth
Upload	<input type="text"/> kbps
Download	<input type="text"/> kbps

- **Service:** Select **Enable** to turn on bandwidth control through the access point.
- **Mode:** Select the bandwidth control mode to use through the access point.
- **Upload:** Enter **the upload bandwidth speeds**
- **Download:** Enter the download bandwidth speeds

Routing

This section allows you to configure the routing of the access point.

- **OSPF:** Select **Enable** to enable OSPF setting

OSPF Settings	
OSPF Service	<input checked="" type="radio"/> Enable <input type="radio"/> Disable
RouterID	<input type="text" value="192.168.10.100 (LAN)"/>
Network(WAN)	<input checked="" type="checkbox"/> WAN Area <input type="text"/>
Network(LAN)	<input checked="" type="checkbox"/> LAN Area <input type="text"/>
	<input checked="" type="checkbox"/> Distribute RIP over OSPF

- **RouterID:** Select the ID to configure
- **Network (WAN):** Select to configure the WAN section, enter the area to assign
- **Network (LAN):** Select to configure the LAN section, enter the area to assign.
- **Distribute RIP over OSPF:** Check this option to use RIP protocol

• **RIP Settings**

RIP Settings	
RIP Service	<input checked="" type="radio"/> Enable <input type="radio"/> Disable
Side	<input checked="" type="checkbox"/> WAN <input type="checkbox"/> LAN
	<input checked="" type="checkbox"/> Distribute OSPF over RIP

- **RIP Service:** Select **Enable** to use RIP protocol
- **Side:** Select **the network section to apply RIP.**

Status

This section breaks down into subsections of **System Overview, Associated Clients Status, WDS Link Status, Extra Information** and **Event Log**.

System Overview

Display detailed information of **System, Network, LAN and Wireless** in the System Overview page.

- **Device Information:** Display the information of the system.

Device Information	
Mode	Repeater
Host Name	TEW-738APBO
Host Description	10dBi Outdoor PoE Access Point
Firmware Version	V1.0.19
Firmware Date	2014/04/23 09:44:51
Country	US
System Time	2014/05/05 14:49:12
System Up Time	03:58:31
ETH1 MAC	00:22:AA:00:11:07
ETH2 MAC	00:22:AA:00:11:06
Wireless MAC	00:22:AA:00:11:08

- **Operating Mode:** The mode currently in service.
- **Host Name:** The name of the system.
- **Host Description:** A description of the system.
- **Firmware Version:** The current installed firmware version.
- **Firmware Date:** The build time of installed firmware.
- **Device Time:** The current time of the system.
- **System Up Time:** The time period that system has been in service since last reboot.
- **ETH1/ETH2MAC:** Ethernet MAC address of the access point.
- **Wireless MAC:** Wireless MAC address of the access point
- **CPU Loading:** The CPU loading of the access point
- **Memory Used:** Memory usage of the access point.

- **LAN Information:** Display total received and transmitted statistics on the LAN

interface.

LAN Information	
Ethernet Connection Type	Static IP
IP Address	192.168.10.100
IP Netmask	255.255.255.0
IP Gateway	192.168.10.1
DNS	

- **Ethernet Connection Type:** The connection applied on the access point.
- **IP Address:** The management IP of system. By default, it's 192.168.2.254.
- **IP Netmask:** The network mask. By default, it's 255.255.255.0.
- **IP Gateway:** The gateway IP addresses and by default, it's 192.168.2.1.
- **Primary DNS:** The primary DNS server in service.

- **Wireless Information:** Display total received and transmitted statistics on available Virtual AP.

Wireless Information	
WiFi	On
Band	802.11b/g/n
Channel	5
Current Txpower	28 dBm (630 mW)
Data Rate	Auto (300Mb/s)

- **WiFi:** Wireless status of the access point.
- **Band:** Operating wireless band of the access point.
- **Channel:** Operating channel of the access point.
- **Current Tx Power:** Transmit power of the access point.
- **Data Rate:** Current wireless data rate of the access point.

DHCP Client

Display detailed information of the access point's DHCP server.

DHCP Server Status	
Service	Enable
Start IP	192.168.10.101
End IP	192.168.10.254
Default Gateway	192.168.10.100
DNS1	192.168.10.100
DNS2	
WINS	
Domain	
Lease Time	86400

- **Service:** Status of access point's DHCP server
- **Start IP:** Starting IP address of access point's DHCP server
- **End IP:** Last IP address used on the access point's DHCP server
- **Default Gateway:** Assigned gateway address to the access point
- **DNS1/2:** Assigned DNS to the access point's DHCP server
- **WINS:** Assigned WINS to the access point's DHCP server
- **Domain:** Domain assigned to access point
- **Lease Time:** DHCP lease time of access point's DHCP server

DHCP Client List		
IP Address	MAC Address	Expired In
-	-	-

- **DHCP Client list:** List of clients connected to the access point

Extra Information

Users could pull out information such as Route table, ARP table, MAC table, Bridge table or STP available in the drop-down list from system. The "Refresh" button is used to retrieve latest table information.

Extra Information			
Information	Route Information		
Route Information			
Destination	Gateway	Netmask	Interface
192.168.10.0	0.0.0.0	255.255.255.0	bre0
239.0.0.0	0.0.0.0	255.0.0.0	bre0
224.0.0.0	0.0.0.0	224.0.0.0	bre0
0.0.0.0	192.168.10.1	0.0.0.0	bre0

- **Route table information:** Select "Route table information" on the drop-down list to display route table. The access point could be used as a L2 or L3 device. It doesn't support dynamic routing protocols such as RIP or OSPF. Static routes to specific hosts, networks or default gateway are set up automatically according to the IP configuration of system's interfaces. When used as a L2 device, it could switch packets and, as L3 device, it's capable of being a gateway to route packets inward and outward.

Route Information			
Destination	Gateway	Netmask	Interface
192.168.10.0	0.0.0.0	255.255.255.0	bre0
239.0.0.0	0.0.0.0	255.0.0.0	bre0
224.0.0.0	0.0.0.0	224.0.0.0	bre0
0.0.0.0	192.168.10.1	0.0.0.0	bre0

- **ARP table Information:** Select "ARP Table Information" on the drop-down list to display ARP table. ARP associates each IP address to a unique hardware address (MAC) of a device. It is important to have a unique IP address as final destination to switch packets to.

ARP Table Information		
IP Address	MAC Address	Interface
192.168.10.123	00:26:2d:5b:46:53	bre0

- **Bridge table information:** Select “**Bridge Table information**” on the drop-down list to display bridge table. Bridge table will show Bridge ID and STP's Status on the each Ethernet bridge and its attached interfaces, the Bridge Port should be attached to some interfaces (e.g. eth2, ra0~ra6 and wds0~wds3).

Bridge Table Information			
Bridge Port	Bridge ID	STP Enabled	Interface
LAN	8000.0022aa001106	no	eth1
			eth0
			ath0

- **Bridge MAC information:** Select “**Bridge MACs Information**” on the drop-down list to display MAC table.

Bridge MACs Table Information			
Port	MAC Address	Local	Ageing Timer
VAP0	00:14:d1:c2:da:84	no	3.17
LAN	00:22:aa:00:11:06	yes	0.00
WAN	00:22:aa:00:11:07	yes	0.00
VAP0	00:22:aa:00:11:08	yes	0.00
WAN	00:26:2d:5b:46:53	no	0.04

This table displays local MAC addresses associated with wired or wireless interfaces, but also remember non-local MAC addresses learned from wired or wireless interfaces. Ageing timers will be reset when existing MAC addresses in table are learned again or added when new MAC addresses are seen from wired or wireless interfaces as well. When time runs out for a particular entry, it will be pruned from the table. In that situation, switching packet to that particular MAC address will be dropped.

Event Log

The Event log displays system events when system is up and running. Also, it becomes very useful as a troubleshooting tool when issues are experienced in system.

Time	Facility	Severity	Message
2013-07-06 03:32:47	System	Info	Authentication successful for admin from 192.168.10.123

- **Time:** The date and time when the event occurred.
- **Facility:** It helps users to identify source of events such “System” or “User”
- **Severity:** Severity level that a specific event is associated such as “info”, “error”, “warning”, etc.
- **Message:** Description of the event.

Click **Refresh** button to renew the log, or click **Clear** button to clear all the record.

Associated Client List

List of all clients associated to the access point.

#	MAC Address	RSSI	TX/RX Rate	TX/RX SEQ	TX/RX Bytes	Connect Time	Actions
No such device							

- **MAC Address:** Display MAC address of WDS peer.
- **RSSI:** Indicate the signal strength of the respective WDS links.
- **TX/RX SEQ:** Transmit and receive sequence.
- **TX/RX Bytes:** Transmit and receive bytes

Remote AP status

List the current status of the remote access point.

ESSID	MAC Address	Signal/Noise	RSSI	Signal Quality, %	TX/RX Rate	Status
TRENDnet7380_2.4GHz		0 / 0	0	0%	0M / 0M	Unlinked

- **ESSID:** SSID of remote access point
- **MAC Address:** Display MAC address of WDS peer.
- **RSSI:** Indicate the signal strength of the respective WDS links.
- **TX/RX SEQ:** Transmit and receive sequence.
- **TX/RX Bytes:** Transmit and receive bytes
- **Status:** Display current association status of remote access point

System Management

Configure Management

Administrator could specify geographical location of the system via instructions in this page. Administrator could also enter new Root and Admin passwords and allow multiple login methods.

Please click **System -> Management** and follow the below settings.

- **System Information**

System Information	
System Name	TEW-738APBO
Description	10dB Outdoor PoE Access Point
Location	

- **System Name:** Enter a desired name or use the default one.
- **Description:** Provide description of the system.
- **Location:** Enter geographical location information of the system. It helps administrator to locate the system easier.

- **Admin Password:**

admin Password	
New admin Password	
Check admin Password	

- **New Password :** Enter a new password if desired
- **Check New Password:** Enter the same new password again to check.

- **Admin Login Methods:**

Login Methods		
Enable HTTP	<input checked="" type="checkbox"/>	Port: 80
Enable HTTPS	<input type="checkbox"/>	Port: 443
Enable Telnet	<input checked="" type="checkbox"/>	Port: 23
Enable SSH	<input type="checkbox"/>	Port: 22 <input type="button" value="GenerateKey"/>
Host Key Footprint	None	

- **Enable HTTP:** Check to select HTTP Service.
- **HTTP Port:** The default is 80 and the range is between 1 ~ 65535.
- **Enable HTTPS:** Check to select HTTPS Service
- **HTTPS Port:** The default is 443 and the range is between 1 ~ 65535.
- **Enable Telnet:** Check to select Telnet Service
- **Telnet Port:** The default is 23 and the range is between 1 ~ 65535.
- **Enable SSH:** Check to select SSH Service
- **SSH Port:** The default is 22 and the range is between 1 ~ 65535.

- **Ping Watchdog:** The ping watchdog sets the access point to continuously ping a user defined IP address (it can be the internet gateway for example). If it is unable to ping under the user defined constraints, the access point will automatically reboot. This option creates a kind of "fail-proof" mechanism.

Ping Watchdog is dedicated for continuous monitoring of the particular connection to remote host using the Ping tool. The Ping works by sending ICMP "echo request" packets to the target host and listening for ICMP "echo response" replies. If the defined number of replies is not received, the tool reboots the device.

Ping Watchdog	
Service	<input checked="" type="radio"/> Enable <input type="radio"/> Disable
IP Address To Ping	
Ping Interval	300 Seconds
Startup Delay	300 Seconds
Failure Count To Reboot	3

- **Enable Ping Watchdog:** control will enable Ping Watchdog Tool.
- **IP Address To Ping:** specify an IP address of the target host which will be monitored by Ping Watchdog Tool.
- **Ping Interval:** specify time interval (in seconds) between the ICMP "echo requests" are sent by the Ping Watchdog Tool. Default is **300** seconds.
- **Startup Delay:** specify initial time delay (in seconds) until first ICMP "echo requests" are sent by the Ping Watchdog Tool. The value of Startup Delay should be at least **60** seconds as the network interface and wireless connection initialization takes considerable amount of time if the device is rebooted. Default is **300** seconds.

- **Failure Count To Reboot:** specify the number of ICMP “echo response” replies. If the specified number of ICMP “echo response” packets is not received continuously, the Ping Watchdog Tool will reboot the device.

Click **Save** button to save your changes. Click **Reboot** button to activate your changes

Without a valid certificate, users may encounter the following problem in IE7 when they try to access system's WMI (<https://192.168.2.254>). There will be a “Certificate Error”, because the browser treats system as an illegal website.

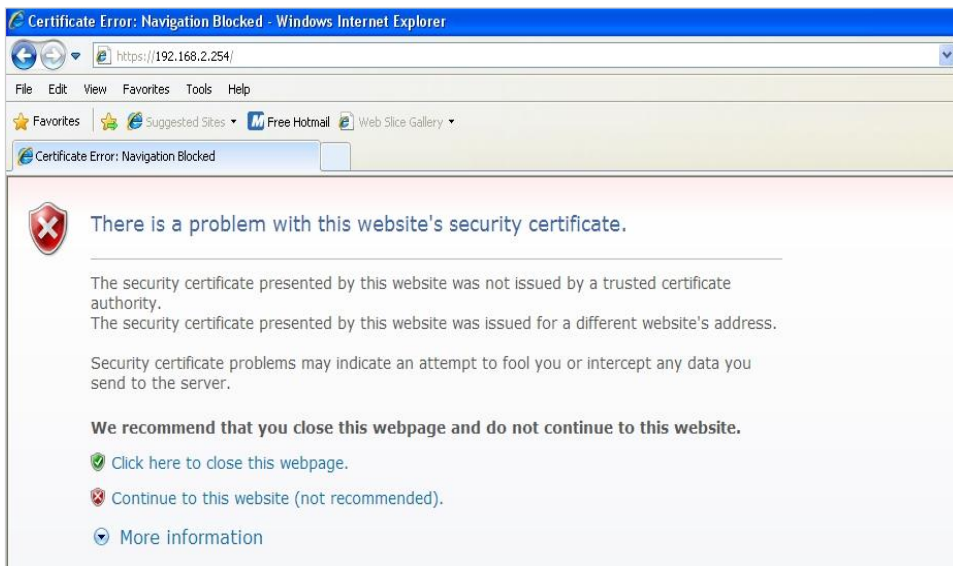

Click “**Continue to this website**” to access the system's WMI. The system's Overview page will appear.

Configure System Time

System time can be configured via this page and manual setting or via a NTP server is supported.

Please click on **System -> Time Server** and follow the below setting.

System Time	
Local Time	2013/07/01 03:39:49
Time Mode	
Mode	<input type="radio"/> NTP Server <input checked="" type="radio"/> Manual
User Setup	
Date	2014 - May - 5
Time	14 - 30 - 52 (GMT-7:00)
Set Time	<input type="button" value="Set Time"/>

- **Local Time:** Display the current system time.
- **NTP Client:** To synchronize the system time with NTP server.
 - **Enable:** Check to select NTP client.
 - **Default NTP Server:** Select the NTP Server from the drop-down list.
 - **Time Zone:** Select a desired time zone from the drop-down list.
 - **Daylight saving time:** Enable or disable Daylight saving.

Click **Save** button to save your changes. Click **Reboot** button to activate your changes.

Configure SNMP Setup

SNMP is an application-layer protocol that provides a message format for communication between SNMP managers and agents. By enabling SNMP function, the administrator can obtain the system information remotely.

Please click on **System -> SNMP Setup** and follow the below setting.

SNMP v2c	
Enable	<input type="checkbox"/>
SNMP v3	
Enable	<input checked="" type="checkbox"/>
SNMP Trap	
Enable	<input type="checkbox"/>

- **SNMP v2c Enable:** Check to enable SNMP v2c.

SNMP v2c	
Enable	<input checked="" type="checkbox"/>
ro community	<input type="text"/>
rw community	<input type="text"/>

- **ro community:** Set a community string to authorize read-only access.
- **rw community:** Set a community string to authorize read/write access.
- **SNMP v3 Enable:** Check to enable SNMP v3. SNMPv3 supports the highest level SNMP security.

SNMP v3	
Enable	<input checked="" type="checkbox"/>
SNMP ro user	<input type="text"/>
SNMP ro password	<input type="text"/>
SNMP rw user	<input type="text"/>
SNMP rw password	<input type="text"/>

- **SNMP ro user:** Set a community string to authorize read-only access.
- **SNMP ro password:** Set a password to authorize read-only access.
- **SNMP rw user:** Set a community string to authorize read/write access.
- **SNMP rw password:** Set a password to authorize read/write access.
- **SNMP Trap:** Events such as cold start, interface up & down, and association & disassociation will report to an assigned server.

SNMP Trap	
Enable	<input checked="" type="checkbox"/>
Community	<input type="text"/>
IP 1	<input type="text"/>
IP 2	<input type="text"/>
IP 3	<input type="text"/>
IP 4	<input type="text"/>

- **Community:** Set a community string required by the remote host computer that

will receive trap messages or notices send by the system.

- **IP:** Enter the IP addresses of the remote hosts to receive trap messages.

Click **Save** button to save changes and click **Reboot** button to activate.

Enable UPNP

Enable UPNP protocol on the access point.

UPNP	
Service	<input type="radio"/> Enable <input checked="" type="radio"/> Disable

- **Service:**
 - **Enable:** Select to enable UPNP through the access point
 - **Disable:** Select to disable UPNP

Backup / Restore and Reset to Factory

Backup current configuration, restore prior configuration or reset back to factory default configuration can be executed via this page.

Please click on **Utilities -> Profile Setting** and follow the below setting.

Profile Setting	
In this page, you can save your current configuration, restore a previously saved configuration, or restore all of the settings in the system to the factory (default) settings.	
Save Settings to PC	<input type="button" value="Save"/>
Load Settings From PC	<input type="button" value="Browse..."/> No file selected. <input type="button" value="Upload"/>
Reset To Factory Default	<input type="button" value="Default"/>

- **Save Settings to PC:** Click **Save** to save current access point configuration settings to a computer.
- **Load Settings from PC:** Click **Browse** button to locate a configuration file to restore, and then click **Upload** button to upload.
- **Reset To Factory Default:** Click **Default** button to reset back to the factory default settings and expect **Successful** loading message. Then, click **Reboot** button to activate.

Firmware Upgrade

Firmware is the main software image that system needs to respond to requests and to manage real time operations. Firmware upgrades are sometimes required to include new features or bugs fix. It takes around **2 minutes** to upgrade due to complexity of firmware. To upgrade system firmware, click **Browse** button to locate the new firmware, and then click **Upgrade** button to upgrade.

Firmware Information	
From time to time, the product may release new versions of the system's firmware. You can download up-to-date firmware to upgrade system.	
Firmware Version	V1.0.19
Firmware Date	2014/04/23 09:44:51
Upgrade Via Local PC	
Select File	<input type="button" value="Browse..."/> No file selected. <input type="button" value="Upgrade"/>
Upgrade Via TFTP Server	
TFTP Server IP	<input type="text"/>
File Name	<input type="text"/> <input type="button" value="Upgrade"/>
Upgrade Via HTTP URL	
URL	<input type="text"/> <input type="button" value="Upgrade"/>

- **Firmware Version:** Access point's current firmware version
- **Firmware Date:** Firmware date of access point
- **Select File:** Click **Browse** button to locate a configuration file to restore, and then click **Upgrade** button to upload.
- TFTP Server IP: Enter the IP address of the TFTP server to use for firmware upgrade
- File: Enter the location of the firmware file to use, and then click **Upgrade** button to upload.
- **URL:** Enter the URL to use to upgrade access point's firmware. Then, click **Reboot** button to activate.

Network Utility

The administrator can diagnose network connectivity via the PING and TRACEROUTE utility.

Please click on **Utilities** -> **Network Utility** and follow the below setting

Ping	
IP/Domain	<input type="text"/> Times <input type="text" value="5"/> <input type="button" value="Start"/>
Traceroute	
Destination Host	<input type="text"/> Max. Hops <input type="text" value="6"/> <input type="button" value="Start"/> <input type="button" value="Stop"/>
Result	
<div style="border: 1px solid black; height: 150px;"></div>	

- **Ping:** This utility will help ping other devices on the network to verify connectivity. Ping utility, using ICMP packets, detects connectivity and latency between two network nodes. As result of that, packet loss and latency time are available in the **Result** field while running the PING test.
 - **Destination IP/Domain:** Enter desired domain name, i.e. www.google.com, or IP address of the destination, and click **ping** button to proceed. The ping result will be shown in the **Result** field.
 - **Count:** By default, it's 5 and the range is from 1 to 50. It indicates number of connectivity test.
- **Traceroute:** Allows tracing the hops from the access point to select an outgoing IP address. It should be used for the finding the route taken by ICMP packets across the network to the destination host. The test is started using the **Start** button, click **Stop** button to stopped test
 - **Destination Host:** Specifies the Destination Host for the finding the route taken by ICMP packets across the network.
 - **MAX Hop:** Specifies the maximum number of hops(max time-to-live value) traceroute will probe.

Reboot

This function allows user to restart system with existing or most current settings when changes are made. Click **Reboot** button to proceed and take around three minutes to complete.

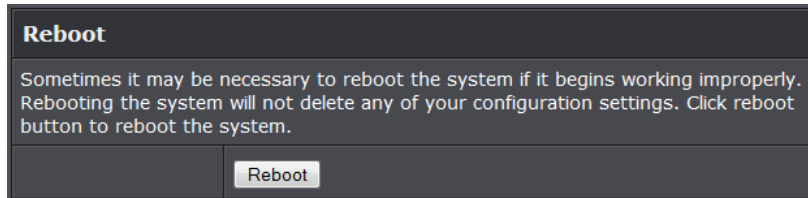

A reminder will be available for remaining time to complete. If power cycle is necessary, please wait till completion of the reboot process.

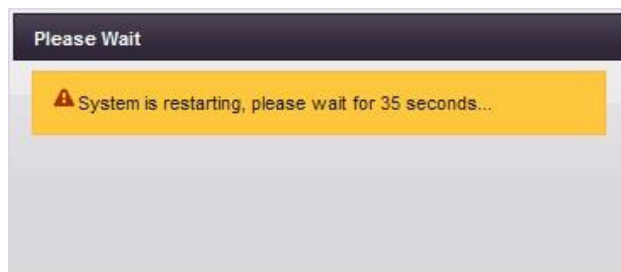

Technical Specifications

Standards

- IEEE 802.3
- IEEE 802.3u
- IEEE 802.1d
- IEEE 802.1p
- IEEE 802.1Q
- IEEE 802.1X
- IEEE 802.11d
- IEEE 802.11e
- IEEE 802.11f
- IEEE 802.11h
- IEEE 802.11i
- IEEE 802.11b
- IEEE 802.11g
- IEEE 802.11n (2.4 GHz up to 300 Mbps)

Hardware Interface

- 1 x 10/100 Mbps port (proprietary PoE max. cable length 70 m)
- Reset button
- LED indicators

Special Features

- IP67 weather rated
- 802.1Q VLAN assignment per SSID
- DDNS support for dyn.com, no-ip.com
- Schedule radio on/off time policy

Access Control

- Wireless encryption: WEP, WPA/WPA2-PSK, WPA/WPA2-RADIUS
- Firewall (CPE Mode): NAT, Virtual Server, DMZ Host, PPTP/L2TP/IPsec VPN Passthrough
- Access Controls: MAC, IP Filter, Layer 2 Client Isolation, Per-SSID client limiting
- 802.1Q VLAN

QoS

- WMM
- Diffserv (DSCP)/ToS
- 802.1p/CoS

Operation Modes

- Access Point (AP)
- Wireless Distribution System (WDS)
- AP + WDS
- Repeater
- CPE + AP

SSID

- Up to 8 SSIDs

Internet Connection Types (CPE mode)

- Dynamic IP (DHCP)
- Static IP (Fixed)
- PPPoE (Dynamic IP/Static IP)
- PPTP (Dynamic IP/Static IP)

Management/Monitoring

- Local/remote web based management (HTTP, HTTPS)
- Local/remote CLI based management (Telnet, SSH)
- SNMP v1/v2c/v3
- SNMP Trap
- MIB II
- Upgrade firmware
- Backup/restore configuration
- Event logging
- Reboot
- Restore to factory defaults
- Ping test
- Ping Watchdog

Routing

- Static
- Dynamic (RIP v1/2, OSPF)

Frequency

- FCC: 2.412 - 2.462 GHz
- ETSI: 2.412 - 2.472 GHz
- IC: 2.412 - 2.462 GHz

Wireless Channels

- FCC: 1-11
- ETSI: 1-13

Modulation

- 802.11b: DBPK, DQPSK, CCK with DSSS
- 802.11g/n: BPSK, QPSK, 16-QAM, 64-QAM with OFDM

Media Access Protocol

- CSMA/CA with ACK

Antenna Gain

- 10 dBi internal sector antenna

Wireless Output Power/Receiving Sensitivity

- 802.11b: FCC/ETSI: FCC: 28 dBm (max.), ETSI: 10.6 dBm (max.), IC: 28 dBm (max.)/-88 dBm (typical) @ 11 Mbps
- 802.11g: FCC/ETSI: FCC: 27 dBm (max.), ETSI: 10.7 dBm (max.), IC: 27 dBm (max.)/- 74 dBm (typical) @ 54 Mbps
- 802.11n: FCC/ETSI: FCC: 28 dBm (max.), ETSI: 10.7 dBm (max.), IC: 28 dBm (max.)/- 69 dBm (typical) @ 300 Mbps

Power

- Input: 100 – 220 V, 50 - 60 Hz, 0.6 A
- Output: 48v / 0.5A
- Consumption: 22 Watts Max.

Operating Temperature

- -30 - 60° C (-22 - 140° F)

Operating Humidity

- Max. 99 % non-condensing

Certifications

- CE
- FCC

Dimensions

- 218 x 125 x 54 mm (8.6 x 4.9 x 2.1 in.)

Weight

- 424 g (0.9 lbs.)

* Effective wireless coverage may vary depending on the wireless device's output power, antenna gain, antenna alignment, receiving sensitivity, and radio interference. Additionally environmental factors such as weather conditions, physical obstacles, and other considerations may affect performance. For optimal results, we recommended consulting a professional installer for site survey, safety precautions, and proper installation.

Appendix

How to find your IP address?

Note: Please note that although the following procedures provided to follow for your operating system on configuring your network settings can be used as general guidelines, however, it is strongly recommended that you consult your computer or operating system manufacturer directly for assistance on the proper procedure for configuring network settings.

Command Prompt Method

Windows 2000/XP/Vista/7/8.1/10

1. On your keyboard, press **Windows Logo+R** keys simultaneously to bring up the Run dialog box.
2. In the dialog box, type **cmd** to bring up the command prompt.
3. In the command prompt, type **ipconfig /all** to display your IP address settings.

MAC OS X

1. Navigate to your **Applications** folder and open **Utilities**.
2. Double-click on **Terminal** to launch the command prompt.
3. In the command prompt, type **ipconfig getifaddr <en0 or en1>** to display the wired or wireless IP address settings.

Note: **en0** is typically the wired Ethernet and **en1** is typically the wireless Airport interface.

Graphical Method

MAC OS 10.6/10.5

1. From the Apple menu, select **System Preferences**.
2. In System Preferences, from the **View** menu, select **Network**.
3. In the Network preference window, click a network port (e.g., Ethernet, AirPort, modem). If you are connected, you'll see your IP address settings under "Status:"

MAC OS 10.4

1. From the Apple menu, select **Location**, and then **Network Preferences**.
2. In the Network Preference window, next to "Show:", select **Network Status**. You'll see your network status and your IP address settings displayed.

Note: If you are experiencing difficulties, please contact your computer or operating system manufacturer for assistance.

How to configure your network settings to obtain an IP address automatically or use DHCP?

Note: Please note that although the following procedures provided to follow for your operating system on configuring your network settings can be used as general guidelines, however, it is strongly recommended that you consult your computer or operating system manufacturer directly for assistance on the proper procedure for configuring network settings.

Windows 7/8.1/10

- a. Go into the **Control Panel**, click **Network and Sharing Center**.
- b. Click **Change Adapter Settings**, right-click the **Local Area Connection** icon.
- c. Then click **Properties** and click **Internet Protocol Version 4 (TCP/IPv4)**.
- d. Then click **Obtain an IP address automatically** and click **OK**.

Windows Vista

- a. Go into the **Control Panel**, click **Network and Internet**.
- b. Click **Manage Network Connections**, right-click the **Local Area Connection** icon and click **Properties**.
- c. Click **Internet Protocol Version (TCP/IPv4)** and then click **Properties**.
- d. Then click **Obtain an IP address automatically** and click **OK**.

Windows XP/2000

- a. Go into the **Control Panel**, double-click the **Network Connections** icon
- b. Right-click the **Local Area Connection** icon and the click **Properties**.
- c. Click **Internet Protocol (TCP/IP)** and click **Properties**.
- d. Then click **Obtain an IP address automatically** and click **OK**.

MAC OS 10.4/10.5/10.6

- a. From the **Apple**, drop-down list, select **System Preferences**.
- b. Click the **Network** icon.
- c. From the **Location** drop-down list, select **Automatic**.
- d. Select and view your Ethernet connection.
 - In MAC OS 10.4, from the **Show** drop-down list, select **Built-in Ethernet** and select the **TCP/IP** tab.
 - In MAC OS 10.5/10.6, in the left column, select **Ethernet**.
- e. Configure TCP/IP to use DHCP.

In MAC 10.4, from the **Configure IPv4**, drop-down list, select **Using DHCP** and click the **Apply Now** button.

In MAC 10.5, from the **Configure** drop-down list, select **Using DHCP** and click the **Apply** button.

In MAC 10.6, from the **Configure** drop-down list, select **Using DHCP** and click the **Apply** button.

f. Restart your computer.

Note: *If you are experiencing difficulties, please contact your computer or operating system manufacturer for assistance.*

How to configure your network settings to use a static IP address?

Note: *Please note that although the following procedures provided to follow for your operating system on configuring your network settings can be used as general guidelines, however, it is strongly recommended that you consult your computer or operating system manufacturer directly for assistance on the proper procedure for configuring network settings.*

Windows 7/8.1/10

- a. Go into the **Control Panel**, click **Network and Sharing Center**.
- b. Click **Change Adapter Settings**, right-click the **Local Area Connection** icon.
- c. Then click **Properties** and click **Internet Protocol Version 4 (TCP/IPv4)**.
- d. Then click **Use the following IP address**, and assign your network adapter a static IP address. Click **OK**

Windows Vista

- a. Go into the **Control Panel**, click **Network and Internet**.
- b. Click **Manage Network Connections**, right-click the **Local Area Connection** icon and click **Properties**.
- c. Click **Internet Protocol Version (TCP/IPv4)** and then click **Properties**.
- d. Then click **Use the following IP address**, and assign your network adapter a static IP address. Click **OK**

Windows XP/2000

- a. Go into the **Control Panel**, double-click the **Network Connections** icon
- b. Right-click the **Local Area Connection** icon and the click **Properties**.
- c. Click **Internet Protocol (TCP/IP)** and click **Properties**.

d. Then click **Use the following IP address**, and assign your network adapter a static IP address. Click **OK**

MAC OS 10.4/10.5/10.6

- a. From the **Apple**, drop-down list, select **System Preferences**.
- b. Click the **Network** icon.
- c. From the **Location** drop-down list, select **Automatic**.
- d. Select and view your Ethernet connection.

How to find your MAC address?

In Windows 2000/XP/Vista/7/8,

Your computer MAC addresses are also displayed in this window, however, you can type **getmac -v** to display the MAC addresses only.

In MAC OS 10.4,

1. **Apple Menu > System Preferences > Network**
2. From the **Show** menu, select **Built-in Ethernet**.
3. On the **Ethernet** tab, the **Ethernet ID** is your MAC Address.

In MAC OS 10.5/10.6,

1. **Apple Menu > System Preferences > Network**
2. Select **Ethernet** from the list on the left.
3. Click the **Advanced** button.
3. On the **Ethernet** tab, the **Ethernet ID** is your MAC Address.

How do I use the ping tool to check for network device connectivity?**Windows 2000/XP/Vista/7/8.1/10**

1. On your keyboard, press **Windows Logo+R** keys simultaneously to bring up the Run dialog box.
2. In the dialog box, type **cmd** to bring up the command prompt.
3. In the command prompt, type **ping <ip_address>** with the *<ip_address>* being the IP address you want ping and check for connectivity.

Example: Usage of ping command and successful replies from device.

```
C:\Users>ping 192.168.10.100
```

```
Pinging 192.168.10.100 with 32 bytes of data:
```

```
Reply from 192.168.10.100: bytes=32 time<1ms TTL=64
```

```
Reply from 192.168.10.100: bytes=32 time<1ms TTL=64
```

```
Reply from 192.168.10.100: bytes=32 time<1ms TTL=64
```

```
Reply from 192.168.10.100: bytes=32 time<1ms TTL=64
```

Ping statistics for 192.168.10.100:

```
Packets: Sent = 4, Received = 4, Lost = 0 (0% loss),
```

Approximate round trip times in milli-seconds:

```
Minimum = 0ms, Maximum = 0ms, Average = 0ms
```

MAC OS X



1. Navigate to your **Applications** folder and open **Utilities**.
2. Double-click on **Terminal** to launch the command prompt.
3. In the command prompt, type **ping -c <#> <ip_address>** with the *<#>* ping being the number of time you want to ping and the *<ip_address>* being the IP address you want ping and check for connectivity.

Example: `ping -c 4 192.168.10.100`

How to connect to a wireless network using the built-in Windows utility?

Note: Please note that although the following procedures provided to follow for your operating system on configuring your network settings can be used as general guidelines, however, it is strongly recommended that you consult your computer or operating system manufacturer directly for assistance on the proper procedure for connecting to a wireless network using the built-in utility.

Windows 7/8.1/10

1. Open Connect to a Network by clicking the network icon ( or ) in the notification area.
2. In the list of available wireless networks, click the wireless network you would like to connect to, then click **Connect**.
4. You may be prompted to enter a security key in order to connect to the network.
5. Enter in the security key corresponding to the wireless network, and click **OK**.

Windows Vista

1. Open Connect to a Network by clicking the **Start Button**  and then click **Connect To**.
2. In the **Show** list, click **Wireless**.
3. In the list of available wireless networks, click the wireless network you would like to connect to, then click **Connect**.
4. You may be prompted to enter a security key in order to connect to the network.
5. Enter in the security key corresponding to the wireless network, and click **OK**.

Windows XP

1. Right-click the network icon in the notification area, then click **View Available Wireless Networks**.
2. In **Connect to a Network**, under **Available Networks**, click the wireless network you would like to connect to.
3. You may be prompted to enter a security key in order to connect to the network.
4. Enter in the security key corresponding to the wireless network, and click **Connect**.

Federal Communication Commission Interference Statement

This equipment has been tested and found to comply with the limits for a Class B digital device, pursuant to Part 15 of the FCC Rules. These limits are designed to provide reasonable protection against harmful interference in a residential installation. This equipment generates, uses and can radiate radio frequency energy and, if not installed and used in accordance with the instructions, may cause harmful interference to radio communications. However, there is no guarantee that interference will not occur in a particular installation. If this equipment does cause harmful interference to radio or television reception, which can be determined by turning the equipment off and on, the user is encouraged to try to correct the interference by one of the following measures:

- Reorient or relocate the receiving antenna.
- Increase the separation between the equipment and receiver.
- Connect the equipment into an outlet on a circuit different from that to which the receiver is connected.
- Consult the dealer or an experienced radio/TV technician for help.



FCC Caution: Any changes or modifications not expressly approved by the party responsible for compliance could void the user's authority to operate this equipment.

This device complies with Part 15 of the FCC Rules. Operation is subject to the following two conditions: (1) This device may not cause harmful interference, and (2) this device must accept any interference received, including interference that may cause undesired operation.

IMPORTANT NOTE:

Radiation Exposure Statement:

This equipment complies with FCC radiation exposure limits set forth for an uncontrolled environment. This equipment should be installed and operated with minimum distance 20cm between the radiator & your body.

This transmitter must not be co-located or operating in conjunction with any other antenna or transmitter.

Country Code selection feature to be disabled for products marketed to the US/CANADA

Europe – EU Declaration of Conformity

TRENDnet hereby declare that the product is in compliance with the essential requirements and other relevant provisions under our sole responsibility.

Safety

EN 60950-1: 2006 + A11: 2009: +A1: 2010 + A12: 2011 + A2: 2013

EMC

EN 301 489-1 V1.9.2: 09-2011

EN 301 489-17 V2.2.1: 09-2012

EN 55022: 2010 + AC: 2011

EN 55024: 2010

Radio Spectrum & Health

EN 300 328 V1.8.1



This product is herewith confirmed to comply with the Directives.

Directives

Low Voltage Directive 2006/95/EC and 2014/35/EU

EMC Directive 2004/108/EC and 2014/30/EU

R&TTE Directive 1999/5/EC

RoHS Directive 2011/65/EU

REACH Regulation (EC) No. 1907/2006

This device is designed to provide uninterrupted monitoring and/or recording. This device does not offer power management functionality such as Off mode or Standby mode.

cs Český [Czech]	TRENDnet tímto prohlašuje, že tento TEW-740APBO je ve shodě se základními požadavky a dalšími příslušnými ustanoveními směrnice 1999/5/ES, 2011/65/EU, 2014/35/EU, 2014/30/EU, 2004/108/ES, 2011/65/EU, a 2006/95/ES.
da Dansk [Danish]	Undertegnede TRENDnet erklærer herved, at følgende udstyr TEW-740APBO overholder de væsentlige krav og øvrige relevante krav i direktiv 1999/5/EF, 2014/35/EU, 2014/30/EU, 2004/108/EF, 2011/65/EU, og 2006/95/EF.
de Deutsch [German]	Hiermit erklärt TRENDnet, dass sich das Gerät TEW-740APBO in Übereinstimmung mit den grundlegenden Anforderungen und den übrigen einschlägigen Bestimmungen der Richtlinie 1999/5/EG, 2014/35/EU, 2014/30/EU, 2004/108/EG, 2011/65/EU, und 2006/95/EG befindet.
et Eesti [Estonian]	Käesolevaga kinnitab TRENDnet seadme TEW-740APBO vastavust direktiivi 1999/5/EÜ, 2014/35/EU, 2014/30/EU, 2004/108/EÜ, 2011/65/EU, ja 2006/95/EÜ põhinõuetele ja nimetatud direktiivist tulenevatele teistele asjakohastele sätetele.
en English	Hereby, TRENDnet, declares that this TEW-740APBO is in compliance with the essential requirements and other relevant provisions of Directive 1999/5/EC, 2014/35/EU, 2014/30/EU, 2004/108/EC, 2011/65/EU, and 2006/95/EC.
es Español [Spanish]	Por medio de la presente TRENDnet declara que el TEW-740APBO cumple con los requisitos esenciales y cualesquiera otras disposiciones aplicables o exigibles de la Directiva 1999/5/CE, 2014/35/EU, 2014/30/EU, 2004/108/CE, 2006/95/CE, 2011/65/EU y.
el Ελληνική [Greek]	ΜΕ ΤΗΝ ΠΑΡΟΥΣΙΑ ΤΡΕΝΔΝΕΤ ΔΗΛΩΝΕΙ ΟΤΙ ΤΟ TEW-740APBO ΣΥΜΜΟΡΦΩΝΕΤΑΙ ΠΡΟΣ ΤΙΣ ΟΥΣΙΩΔΕΙΣ ΑΠΑΙΤΗΣΕΙΣ ΚΑΙ ΤΙΣ ΛΟΙΠΕΣ ΣΧΕΤΙΚΕΣ ΔΙΑΤΑΞΕΙΣ ΤΗΣ ΟΔΗΓΙΑΣ 1999/5/ΕΚ, 2014/35/ΕΥ, 2014/30/ΕΥ, 2004/108/ΕΚ, 2006/95/ΕΚ, 2011/65/ΕΥ κα.
fr Français [French]	Par la présente TRENDnet déclare que l'appareil TEW-740APBO est conforme aux exigences essentielles et aux autres dispositions pertinentes de la directive 1999/5/CE, 2014/35/UE, 2014/30/UE, 2004/108/CE, 2006/95/CE, 2011/65/UE et.
it Italiano [Italian]	Con la presente TRENDnet dichiara che questo TEW-740APBO è conforme ai requisiti essenziali ed alle altre disposizioni pertinenti stabilite dalla direttiva 1999/5/CE, 2014/35/EU, 2014/30/EU, 2004/108/CE, 2011/65/EU, e 2006/95/CE.
Latviski [Latvian]	Ar šo TRENDnet deklarē, ka TEW-740APBO atbilst Direktīvas 1999/5/EK, 2014/35/EU, 2014/30/EU, 2004/108/EK, 2011/65/EU un 2006/95/EK būtiskajām prasībām un citiem ar to saistītajiem noteikumiem.

Lietuvių [Lithuanian]	Šiuo TRENDnet deklaruoja, kad šis TEW-740APBO atitinka esminius reikalavimus ir kitas 1999/5/EB, 2014/35/EU, 2014/30/EU, 2004/108/EB, 2011/65/EU ir 2006/95/EB Direktyvos nuostatas.
nl Nederlands [Dutch]	Hierbij verklaart TRENDnet dat het toestel TEW-740APBO in overeenstemming is met de essentiële eisen en de andere relevante bepalingen van richtlijn 1999/5/EG, 2014/35/EU, 2014/30/EU, 2004/108/EG, 2011/65/EU en 2006/95/EG.
mt Malti [Maltese]	Hawnhekk, TRENDnet, jiddikjara li dan TEW-740APBO jikkonforma mal-ħtiġijiet essenzjali u ma provvedimenti oħrajn relevanti li hemm fid-Direttiva 1999/5/KE, 2014/35/EU, 2014/30/EU, 2004/108/KE, 2011/65/EU u 2006/95/KE.
hu Magyar [Hungarian]	Alulírott, TRENDnet nyilatkozom, hogy a TEW-740APBO megfelel a vonatkozó alapvető követelményeknek és az 1999/5/EK, 2014/35/EU, 2014/30/EU, 2004/108/EK, 2011/65/EU irányelv és a 2006/95/EK irányelv egyéb előírásainak.
pl Polski [Polish]	Niniejszym TRENDnet oświadcza, że TEW-740APBO jest zgodny z zasadniczymi wymogami oraz pozostałymi stosownymi postanowieniami Dyrektywy 1999/5/WE, 2014/35/EU, 2014/30/EU, 2004/108/WE, 2011/65/EU i 2006/95/WE.
pt Português [Portuguese]	TRENDnet declara que este TEW-740APBO está conforme com os requisitos essenciais e outras disposições da Directiva 1999/5/CE, 2014/35/EU, 2014/30/EU, 2004/108/CE, 2011/65/EU e 2006/95/CE.
sl Slovensko [Slovenian]	TRENDnet izjavlja, da je ta TEW-740APBO v skladu z bistvenimi zahtevami in ostalimi relevantnimi določili direktive 1999/5/ES, 2014/35/EU, 2014/30/EU, 2004/108/ES, 2011/65/EU in 2006/95/ES.
Slovensky [Slovak]	TRENDnet týmto vyhlasuje, že TEW-740APBO spĺňa základné požiadavky a všetky príslušné ustanovenia Smernice 1999/5/ES, 2014/35/EU, 2014/30/EU, 2004/108/ES, 2011/65/EU a 2006/95/ES.
fi Suomi [Finnish]	TRENDnet vakuuttaa täten että TEW-740APBO tyyppinen laite on direktiivin 1999/5/EY, 2014/35/EU, 2014/30/EU, 2004/108/EY, 2011/65/EU ja 2006/95/EY oleellisten vaatimusten ja sitä koskevien direktiivin muiden ehtojen mukainen.
sv Svenska [Swedish]	Härmed intygar TRENDnet att denna TEW-740APBO står i överensstämmelse med de väsentliga egenskapskrav och övriga relevanta bestämmelser som framgår av direktiv 1999/5/EG, 2014/35/EU, 2014/30/EU, 2004/108/EG, 2011/65/EU och 2006/95/EG.

Industry Canada Statement

This device complies with Industry Canada license-exempt RSS standard(s). Operation is subject to the following two conditions: (1) this device may not cause interference, and (2) this device must accept any interference, including interference that may cause undesired operation of the device.

Le présent appareil est conforme aux CNR d'Industrie Canada applicables aux appareils radio exempts de licence. L'exploitation est autorisée aux deux conditions suivantes : (1) l'appareil ne doit pas produire de brouillage, et (2) l'utilisateur de l'appareil doit accepter tout brouillage radioélectrique subi, même si le brouillage est susceptible d'en compromettre le fonctionnement.

Radiation Exposure Statement:

This equipment complies with IC radiation exposure limits set forth for an uncontrolled environment. This equipment should be installed and operated with minimum distance 20cm between the radiator & your body.

Déclaration d'exposition aux radiations:

Cet équipement est conforme aux limites d'exposition aux rayonnements IC établies pour un environnement non contrôlé. Cet équipement doit être installé et utilisé avec un minimum de 20 cm de distance entre la source de rayonnement et votre corps.

Limited Warranty

TRENDnet warrants only to the original purchaser of this product from a TRENDnet authorized reseller or distributor that this product will be free from defects in material and workmanship under normal use and service. This limited warranty is non-transferable and does not apply to any purchaser who bought the product from a reseller or distributor not authorized by TRENDnet, including but not limited to purchases from Internet auction sites.

Limited Warranty

TRENDnet warrants its products against defects in material and workmanship, under normal use and service. Specific warranty periods are listed on each of the respective product pages on the TRENDnet website.

- AC/DC Power Adapter, Cooling Fan, and Power Supply carry a one-year warranty.

Limited Lifetime Warranty

TRENDnet offers a limited lifetime warranty for all of its metal-enclosed network switches that have been purchased in the United States/Canada on or after 1/1/2015.

- Cooling fan and internal power supply carry a one-year warranty

To obtain an RMA, the ORIGINAL PURCHASER must show Proof of Purchase and return the unit to the address provided. The customer is responsible for any shipping-related costs that may occur. Replacement goods will be shipped back to the customer at TRENDnet's expense.

Upon receiving the RMA unit, TRENDnet may repair the unit using refurbished parts. In the event that the RMA unit needs to be replaced, TRENDnet may replace it with a refurbished product of the same or comparable model.

In the event that, after evaluation, TRENDnet cannot replace the defective product or there is no comparable model available, we will refund the depreciated value of the product.

If a product does not operate as warranted during the applicable warranty period, TRENDnet shall reserve the right, at its expense, to repair or replace the defective product or part and deliver an equivalent product or part to the customer. The repair/replacement unit's warranty continues from the original date of purchase. All products that are replaced become the property of TRENDnet. Replacement products may be new or reconditioned. TRENDnet does not issue refunds or credit. Please contact the point-of-purchase for their return policies.

TRENDnet shall not be responsible for any software, firmware, information, or memory data of customer contained in, stored on, or integrated with any products returned to TRENDnet pursuant to any warranty.

There are no user serviceable parts inside the product. Do not remove or attempt to service the product by any unauthorized service center. This warranty is voided if (i) the product has been modified or repaired by any unauthorized service center, (ii) the product was subject to accident, abuse, or improper use, or (iii) the product was subject to conditions more severe than those specified in the manual.

Warranty service may be obtained by contacting TRENDnet within the applicable warranty period and providing a copy of the dated proof of the purchase. Upon proper submission of required documentation, a Return Material Authorization (RMA) number will be issued. An RMA number is required in order to initiate warranty service support for all TRENDnet products. Products that are sent to TRENDnet for RMA service must have the RMA number marked on the outside of return packages and sent to TRENDnet prepaid, insured and packaged appropriately for safe shipment. International customers

shipping from outside of the USA and Canada are responsible for any return shipping and/or customs charges, including but not limited to, duty, tax, and other fees.

Refurbished product: Refurbished products carry a 90-day warranty after date of purchase. Please retain the dated sales receipt with purchase price clearly visible as evidence of the original purchaser's date of purchase. Replacement products may be refurbished or contain refurbished materials. If TRENDnet, by its sole determination, is unable to replace the defective product, we will offer a refund for the depreciated value of the product.

WARRANTIES EXCLUSIVE: IF THE TRENDNET PRODUCT DOES NOT OPERATE AS WARRANTED ABOVE, THE CUSTOMER'S SOLE REMEDY SHALL BE, AT TRENDNET'S OPTION, REPAIR OR REPLACE. THE FOREGOING WARRANTIES AND REMEDIES ARE EXCLUSIVE AND ARE IN LIEU OF ALL OTHER WARRANTIES, EXPRESSED OR IMPLIED, EITHER IN FACT OR BY OPERATION OF LAW, STATUTORY OR OTHERWISE, INCLUDING WARRANTIES OF MERCHANTABILITY AND FITNESS FOR A PARTICULAR PURPOSE. TRENDNET NEITHER ASSUMES NOR AUTHORIZES ANY OTHER PERSON TO ASSUME FOR IT ANY OTHER LIABILITY IN CONNECTION WITH THE SALE, INSTALLATION, MAINTENANCE, OR USE OF TRENDNET'S PRODUCTS.

TRENDNET SHALL NOT BE LIABLE UNDER THIS WARRANTY IF ITS TESTING AND EXAMINATION DISCLOSE THAT THE ALLEGED DEFECT IN THE PRODUCT DOES NOT EXIST OR WAS CAUSED BY CUSTOMER'S OR ANY THIRD PERSON'S MISUSE, NEGLIGENCE, IMPROPER INSTALLATION OR TESTING, UNAUTHORIZED ATTEMPTS TO REPAIR OR MODIFY, OR ANY OTHER CAUSE BEYOND THE RANGE OF THE INTENDED USE, OR BY ACCIDENT, FIRE, LIGHTNING, OR OTHER HAZARD.

LIMITATION OF LIABILITY: TO THE FULL EXTENT ALLOWED BY LAW, TRENDNET ALSO EXCLUDES FOR ITSELF AND ITS SUPPLIERS ANY LIABILITY, WHETHER BASED IN

CONTRACT OR TORT (INCLUDING NEGLIGENCE), FOR INCIDENTAL, CONSEQUENTIAL, INDIRECT, SPECIAL, OR PUNITIVE DAMAGES OF ANY KIND, OR FOR LOSS OF REVENUE OR PROFITS, LOSS OF BUSINESS, LOSS OF INFORMATION OR DATE, OR OTHER FINANCIAL LOSS ARISING OUT OF OR IN CONNECTION WITH THE SALE, INSTALLATION, MAINTENANCE, USE, PERFORMANCE, FAILURE, OR INTERRUPTION OF THE POSSIBILITY OF SUCH DAMAGES, AND LIMITS ITS LIABILITY TO REPAIR, REPLACEMENT, OR REFUND OF THE PURCHASE PRICE PAID, AT TRENDNET'S OPTION. THIS DISCLAIMER OF LIABILITY FOR DAMAGES WILL NOT BE AFFECTED IF ANY REMEDY PROVIDED HEREIN SHALL FAIL OF ITS ESSENTIAL PURPOSE.

Governing Law: This Limited Warranty shall be governed by the laws of the state of California.

Some TRENDnet products include software code written by third party developers. These codes are subject to the GNU General Public License ("GPL") or GNU Lesser General Public License ("LGPL").

Visit <http://www.trendnet.com/gpl> or the support section on <http://www.trendnet.com> and search for the desired TRENDnet product to access to the GPL Code or LGPL Code. These codes are distributed WITHOUT WARRANTY and are subject to the copyrights of the developers. TRENDnet does not provide technical support for these codes. Please visit <http://www.gnu.org/licenses/gpl.txt> or <http://www.gnu.org/licenses/lgpl.txt> for specific terms of each license.

PWP07172015v3

2016/04/08



Product Warranty Registration

Please take a moment to register your product online.
Go to TRENDnet's website at <http://www.trendnet.com/register>

TRENDnet
20675 Manhattan Place
Torrance, CA 90501. USA