



TruVision 11/31 Series IP Camera Installation Guide

Copyright	© 2015 United Technologies Corporation, Interlogix is part of UTC Building & Industrial Systems, a unit of United Technologies Corporation. All rights reserved.
Trademarks and patents	Trade names used in this document may be trademarks or registered trademarks of the manufacturers or vendors of the respective products.
Manufacturer	Interogix 2955 Red Hill Avenue, Costa Mesa, CA 92626-5923, USA Authorized EU manufacturing representative: UTC Fire & Security B.V. Kelvinstraat 7, 6003 DH Weert, The Netherlands
Certification	 
FCC compliance	Class A: This equipment has been tested and found to comply with the limits for a Class A digital device, pursuant to part 15 of the FCC Rules. These limits are designed to provide reasonable protection against harmful interference when the equipment is operated in a commercial environment. This equipment generates, uses, and can radiate radio frequency energy and, if not installed and used in accordance with the instruction manual, may cause harmful interference to radio communications. Operation of this equipment in a residential area is likely to cause harmful interference in which case the user will be required to correct the interference at his own expense.
ACMA compliance	Notice! This is a Class A product. In a domestic environment this product may cause radio interference in which case the user may be required to take adequate measures.
Canada	This Class A digital apparatus complies with Canadian ICES-003. Cet appareil numérique de la classe A est conforme à la norme NMB-0330 du Canada.
European Union directives	12004/108/EC (EMC directive): Hereby, UTC Fire & Security declares that this device is in compliance with the essential requirements and other relevant provisions of Directive 2004/108/EC.



2002/96/EC (WEEE directive): Products marked with this symbol cannot be disposed of as unsorted municipal waste in the European Union. For proper recycling, return this product to your local supplier upon the purchase of equivalent new equipment, or dispose of it at designated collection points. For more information see: www.recyclethis.info.



Contact information

For contact information, see www.interlogix.com or www.utcssecurityproducts.eu.

Content

Introduction 2

Product overview 2

Installation 4

Installation environment 4

Package contents 5

Cable requirements 13

Camera description 14

Setting up the camera 19

Accessing the SD card 20

Mounting the IP mini bullet camera 20

Mounting the IP VF bullet camera 22

Mounting the IP VF dome camera 27

Mounting the IP mini dome camera 31

Mounting the IP wedge dome camera 34

Using the camera with a recorder 36

Using the camera with TruVision Navigator 37

Specifications 37

TruVision IP mini bullet cameras 37

TruVision IP VF bullet cameras 37

TruVision IP mini dome 38

TruVision IP VF mini dome cameras 39

TruVision IP wedge cameras 40

Pin definitions 41

Introduction

Product overview

This is the installation guide for TruVision 11-31 Series IP camera models:

IP mini bullet camera:

- TVB-1101 (1.3MPX Bullet, 6mm lens, PAL)
- TVB-3101 (1.3MPX Bullet, 6mm lens, NTSC)
- TVB-1102 (3MPX Bullet, 6mm lens, PAL)
- TVB-3102 (3MPX Bullet, 6mm lens, NTSC)
- TVB-1103 (1.3MPX Bullet, 4mm lens, PAL)
- TVB-3103 (1.3MPX Bullet, 4mm lens, NTSC)

IP VF bullet camera:

- TVB-1104 (1.3MPX Bullet, 2.8 to 12mm VF Lens, PAL)
- TVB-3104 (1.3MPX Bullet, 2.8 to 12mm VF Lens, NTSC)
- TVB-1105 (3MPX Bullet, 2.8 to 12mm VF Lens, PAL)
- TVB-3105 (3MPX Bullet, 2.8 to 12mm VF Lens, NTSC)

IP mini dome camera:

- TVD-1101 (1.3MPX Plastic Mini Dome, PoE, PAL)
- TVD-3101 (1.3MPX Plastic Mini Dome, PoE, NTSC)
- TVD-1102 (3MPX Plastic Mini Dome, PoE, PAL)
- TVD-3102 (3MPX Plastic Mini Dome, PoE, NTSC)

- TVD-1105 (1.3MPX IP IR Outdoor Mini Dome, PoE/12VDC, PAL)
- TVD-3105 (1.3MPX IP IR Outdoor Mini Dome, PoE/12VDC, NTSC)
- TVD-1106 (3MPX IP IR Outdoor Mini Dome, PoE/12VDC, PAL)
- TVD-3106 (3MPX IP IR Outdoor Mini Dome, PoE/12VDC, NTSC)

IP VF mini dome camera:

- TVD-1103 (1.3MPX VF Mini Dome, PAL)
- TVD-3103 (1.3MPX VF Mini Dome, NTSC)
- TVD-1104 (3MPX VF Mini Dome, PAL)
- TVD-3104 (3MPX VF Mini Dome, NTSC)

IP wedge camera:

- TWW-1101 (1.3MPX Wedge, 2.8mm lens, PAL)
- TWW-3101 (1.3MPX Wedge, 2.8mm lens, NTSC)
- TWW-1102 (3MPX Wedge, 2.8mm lens, PAL)
- TWW-3102 (3MPX Wedge, 2.8mm lens, NTSC)

Installation

This section provides information on how to install the cameras.

Installation environment

When installing your product, consider these factors:

- **Electrical:** Install electrical wiring carefully. It should be done by qualified service personnel. Always use a proper PoE switch or a 12 VDCUL listed Class 2 or CE certified power supply to power the camera. Do not overload the power cord or adapter.
- **Ventilation:** Ensure that the location planned for the installation of the camera is well ventilated.
- **Temperature:** Do not operate the camera beyond the specified temperature, humidity or power source ratings. The operating temperature of the camera is between -30 to +60°C (-22 to 140°F). Humidity is below 90%.
- **Moisture:** Do not expose the camera to rain or moisture, or try to operate it in wet areas. Turn the power off immediately if the camera is wet and ask a qualified service person for servicing. Moisture can damage the camera and also create the danger of electric shock.
- **Servicing:** Do not attempt to service this camera yourself. Any attempt to dismantle or remove the covers from this product will invalidate the warranty and may also result in serious injury. Refer all servicing to qualified service personnel.
- **Cleaning:** Do not touch the sensor modules with fingers. If cleaning is necessary, use a clean cloth with some ethanol and wipe the camera gently. If the camera will not

be used for an extended period of time, put on the lens cap to protect the sensors from dirt.

Package contents

Check the package and contents for visible damage. If any components are damaged or missing, do not attempt to use the unit; contact the supplier immediately. If the unit is returned, it must be shipped back in its original packaging.

IP mini bullet camera

Camera

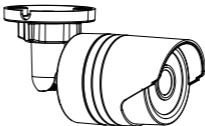

Installation manual



CD with Configuration manual and TruVision Device Finder



Template

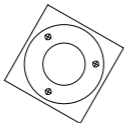

Water joint: provides water resistance to network connection.



Screws

Drywall anchor
 $\Phi 7.5 \times 24.5\text{mm}$ (3 pcs)



Screw M4
(4 x 25mm) (3 pcs)



12 VDC connector: DC jack socket to terminal connectors with positive and negative indicators.

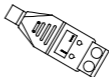

IP VF bullet camera

Camera

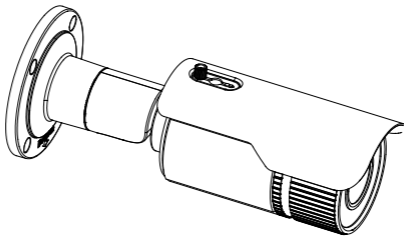

Installation manual

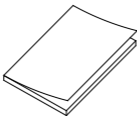

CD with Configuration manual and TruVision Device Finder



Template

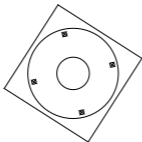

Screws

Drywall anchor
 $\Phi 7.5 \times 24.5\text{mm}$ (4 pcs)



Screw M4
(4 x 25mm (4 pcs)



Water joint: provides water resistance to network connection.



12 VDC Connector: DC jack socket to terminal connectors with positive and negative indicators.

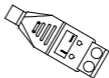

Video test cable



Back box



Screws C: M4.8×18, 4pcs



IP mini dome camera

Camera

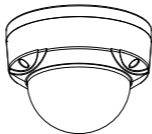

Installation manual



CD with Configuration manual and TruVision Device Finder



Template

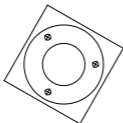

Screws

Drywall anchor
 $\Phi 7.5 \times 24.5\text{mm}$ (3 pcs)



Screw M4
(4 x 25mm (3 pcs)



Water joint: provides water resistance to network connection.



12 VDC Connector: DC jack socket to terminal connectors with positive and negative indicators (TVD-1105 / 3105 / 1106 / 3106 only).

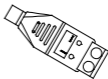

Screws B
(4 x 75mm, 3pcs)



Hex wrench



IP VF dome camera

Camera

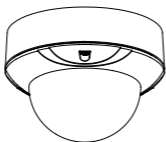

Installation manual



CD with Configuration
manual and TruVision
Device Finder



Template

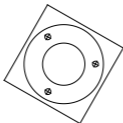

Screws

Drywall anchor
 $\Phi 7.5 \times 24.5\text{mm}$ (4 pcs)



Screw M4
(4 x 25mm (4 pcs)



Water joint: provides water resistance to network connection.



12 VDC connector: DC jack socket to terminal connectors with positive and negative indicators.

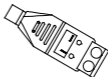

Video test cable



Hex wrench



Screws C: M4×19, 3pcs



Adaptor

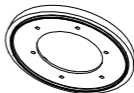

IP wedge camera

Camera

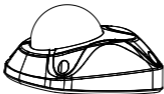

Installation manual

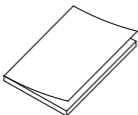

CD with Configuration manual and TruVision Device Finder



Template

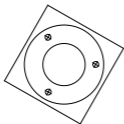

Screws

Drywall anchor
 $\Phi 7.5 \times 24.5\text{mm}$ (3 pcs)



Screw M4
(4 x 25mm (3 pcs)



Water joint: provides water resistance to network connection.



12 VDC connector: DC jack socket to terminal connectors with positive and negative indicators.

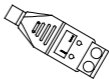

Screws C: M4×8, 2pcs



Hex wrench



Lens adjustment

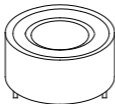

Converter pan

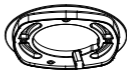

CAUTION: Use direct plug-in UL listed power supplies marked Class 2/CE certified or LPS (limited power source) of the required output rating as listed on the unit.

Cable requirements

For proper operation, adhere to the following cable and power requirements for the cameras. Category 5 cabling or better is recommended. All network cabling must be installed according to applicable codes and regulations.

Camera description

Figure 1: IP mini bullet camera

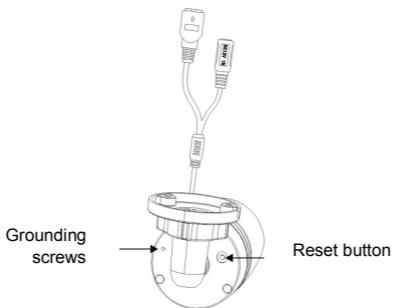
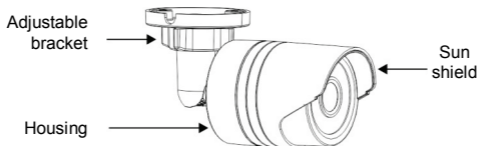
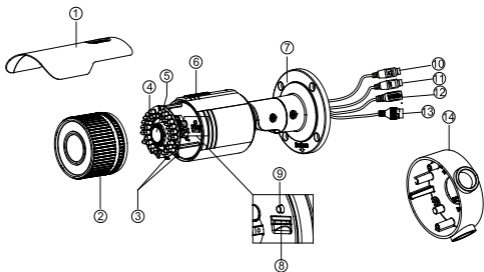
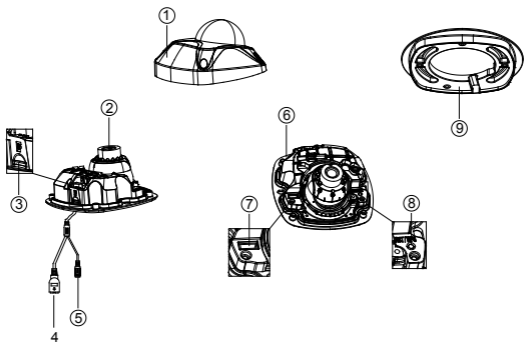

Figure 2: IP VF bullet camera



- | | |
|--------------------|----------------------------|
| 1. Sunshield | 8. SD card slot |
| 2. Front cover | 9. Reset button |
| 3. Lens adjustment | 10. Audio I/O |
| 4. IR LED | 11. Alarm I/O |
| 5. Lens | 12. Power supply |
| 6. Waterproof film | 13. Ethernet RJ45 PoE port |
| 7. Base | 14. Back box |

Figure 3: IP wedge camera



- | | |
|---------------------------|------------------|
| 1. Cover | 6. Base |
| 2. Lens | 7. Serial port |
| 3. SD card | 8. Reset button |
| 4. Ethernet RJ45 PoE port | 9. Converter pan |
| 5. Power supply | |

Figure 4: IP mini dome camera

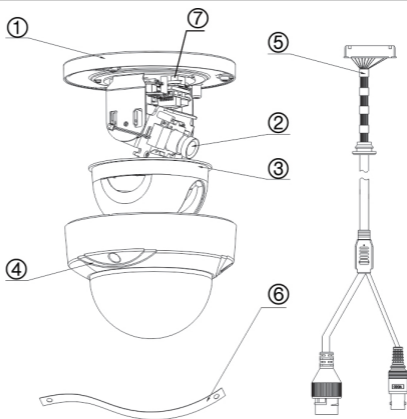

- | | |
|---------------|--------------------------------|
| 1. Base | 5. Ethernet RJ45 and BNC cable |
| 2. Lens | 6. Safety cable |
| 3. Dome liner | 7. Reset button |
| 4. Housing | |

Note: TVD-1105 / 3105 / 1106 / 3106 have a 12 VDC port.

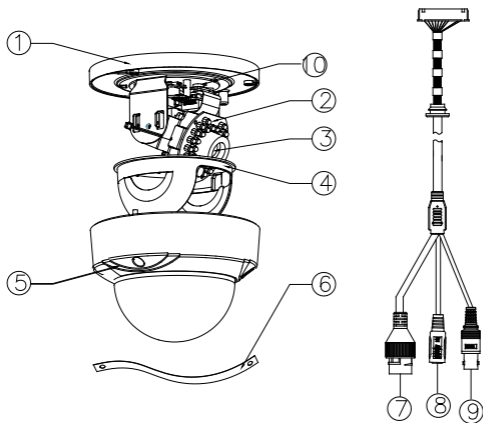

- | | |
|-----------------------|------------------|
| 1. Base | 6. Safety cable |
| 2. IR LED | 7. Ethernet RJ45 |
| 3. Lens | 8. 12 VDC |
| 4. Dome liner housing | 9. BNC cable |
| 5. Housing | 10. Reset button |

Figure 5: IP VF dome camera

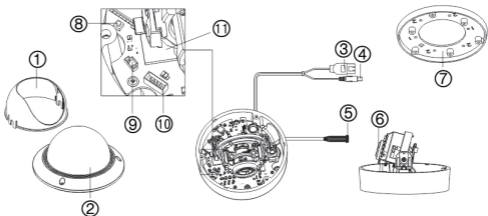

- | | |
|---------------------------|------------------------|
| 1. Dome liner | 7. Mounting plate |
| 2. Housing | 8. Reset button |
| 3. Ethernet RJ45 PoE port | 9. Analog video output |
| 4. Power supply | 10. Serial port |
| 5. Audio and alarm cables | 11. SD card |
| 6. Lens | |

Setting up the camera

Note: If the light source where the camera is installed experiences rapid, wide variations in lighting, the camera may not operate as intended.

To quickly put the camera into operation:

1. Prepare the mounting surface.
2. Mount the camera on the ceiling using the appropriate fasteners. See “Mounting the IP mini bullet camera” on page 20.

3. Set up the camera's network and streaming parameters so that the camera can be controlled over the network. For further information, please refer to the "TruVision IP Camera Configuration Manual".
4. Program the camera to suit its location. For further information, please refer to the "TruVision 11/31 Series IP Camera Configuration Manual".

Accessing the SD card

Insert a Micro SD card with up to 64GB for local storage as a backup in case, for example, the network fails (see Figure 1 on page 14). An SD card is not supplied with the camera.

For the IP VF dome camera, point the lens vertically upwards to access the SD card slot.

For the IP VF bullet camera, remove the sunshield and open the front cover to access the SD card slot.

Video and log files stored on the Micro SD card can only be accessed via the web browser. You cannot access the card using TruVision Navigator or a recording device.

Note: There is no Micro SD card slot in the mini bullet and mini dome cameras.

Mounting the IP mini bullet camera

Mount the camera on a ceiling or wall.

To mount the IP mini bullet camera:

1. Use the supplied template to mark out the mounting area. Drill the screw holes on the ceiling or wall. If you need to route the cables from the camera base, cut a cable hole in the ceiling or wall.

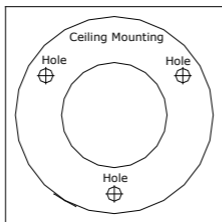

2. Secure the mounting base to the ceiling or wall with the supplied screws.

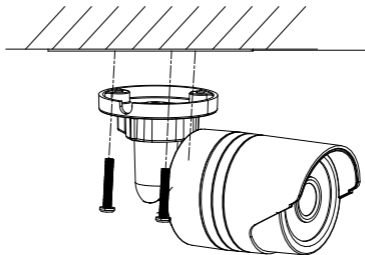

3. Loosen the adjustable nuts on the bracket, and adjust the camera from P/R/T (pan/rotate/tilt) direction.

P direction: 0 to 360°adjustable.

T direction: 0 to 90°adjustable.

R direction: 0 to 360°adjustable

Adjust the lens to the required surveillance angle. Tighten the adjustable nuts to complete the installation.

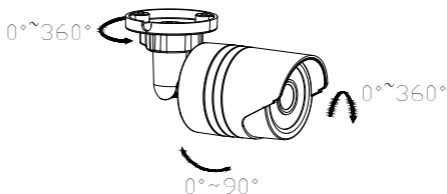

Mounting the IP VF bullet camera

To mount the IP VF bullet camera on a wall:

1. Attach the drill template (supplied) to the wall where the camera is to be mounted. Drill screw holes in the wall according to the number one holes of the drill template.

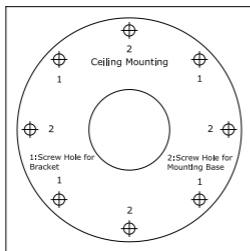

2. If you need to route cables through the wall (or ceiling), cut a cable hole according to the drill template. Skip this step, if you want to route the cables on the surface of the ceiling.
3. Secure the camera to the wall (or ceiling) with expansion screws.

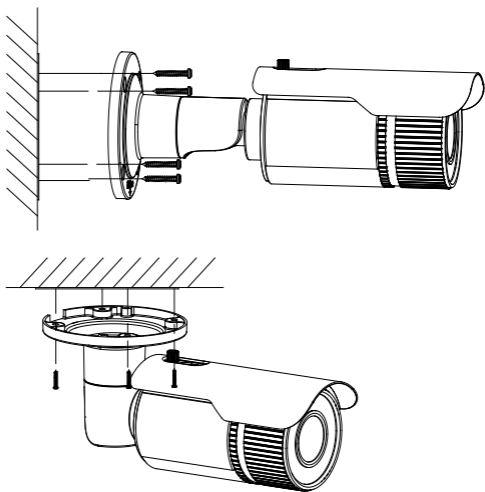

To install the SD card:

1. Rotate the lock screw counterclockwise to loosen it. Slide the sun shield.

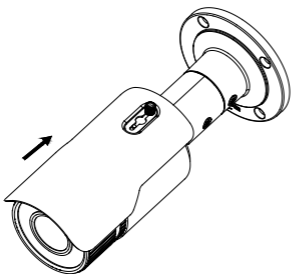

2. Remove the sun shield. Remove the front cover by rotating it counterclockwise.

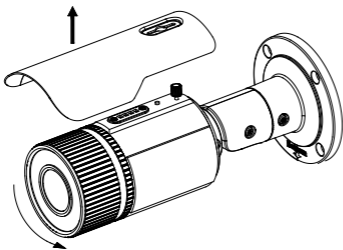

3. Insert the SD card to the SD card slot.

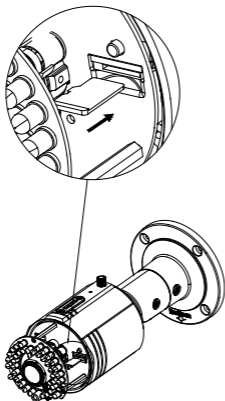

4. Rotate the front cover clockwise back to the camera and replace the sun shield.

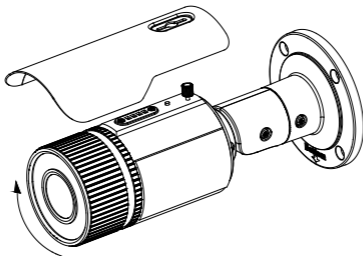

5. Rotate the lock screw clockwise to tighten the sun shield.

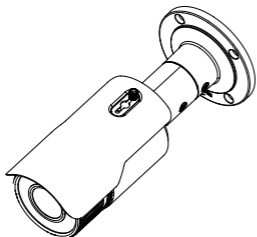

6. To ensure the camera is waterproof, when rotating the front cover clockwise align the rotation label on the front cover with that on the camera.

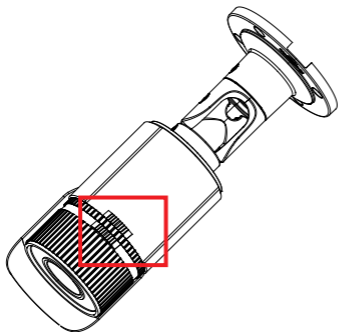

To mount the IP bullet camera with a back box

1. Place the drill template (supplied) on the wall where the camera is to be mounted. Drill holes in the wall according to the number of holes in the drill template.
2. If you need to route cables through the wall (or ceiling), cut a cable hole according to the drill template. Skip this step, if you want to route the cables on the surface of the wall or ceiling.
3. Secure the back box to the wall with expansion screws.
4. Route the cables of the camera.
5. Hook the camera to the back box with the safety cable.
6. Secure the camera to the back box with screws.

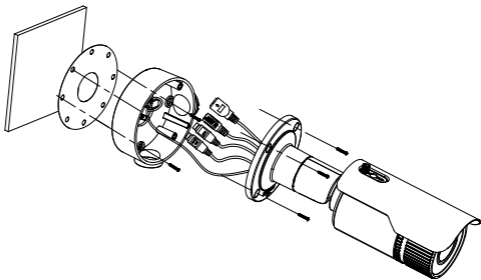

Mounting the IP VF dome camera

To mount the IP VF dome camera on a ceiling or wall:

1. Loosen the three screws on the edge of the lower dome with a screwdriver.

Screw

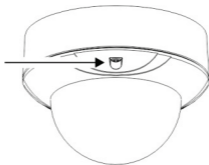

2. Open the lower dome and remove the black inner liner.

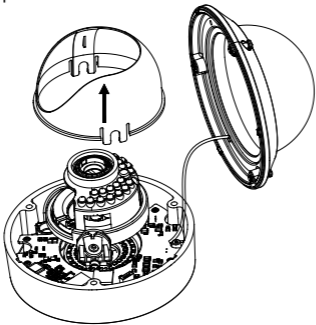

3. Drill the three screw holes on the ceiling with the supplied drill template.

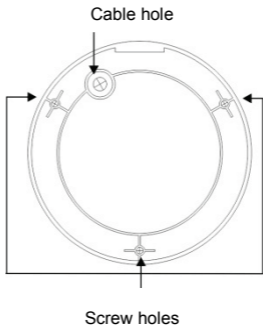

4. If you want to route the cables inside the ceiling, drill a cable hole in the ceiling or wall using the drill template.
5. Attach the camera to the ceiling or wall by aligning the housing holes with those in the ceiling. Secure the camera with the supplied screws as shown below.

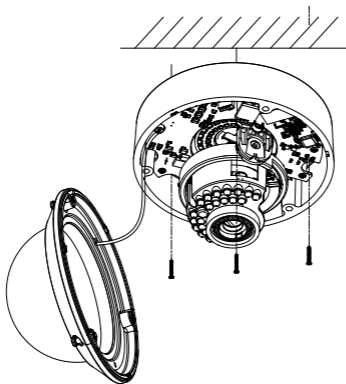

6. Route the cables through the cable hole.

Note: If required, you can route cables through the side screw opening of the camera.

7. Connect the video output connector to the monitor.
Connect the power connector to the power supply.
8. Adjust the image and focus.
 - 1) Three-axis adjustment.
View the camera image using the monitor. Hold the panning table and pull out slightly to adjust the panning position of the camera. Rotate the tilting axes to adjust the tilting position of the camera. Rotate the lens table to adjust the azimuth angle of the image.
 - 2) Zoom and focus adjustment.
Loosen the zoom lever and move the lever between

T(Tele) and W(Wide) to obtain the appropriate angle of view.

- 3) Tighten the zoom lever.
Loosen the focus lever and move the lever between F(Far) and N(Near) to obtain the optimum focus.
Tighten the focus lever.

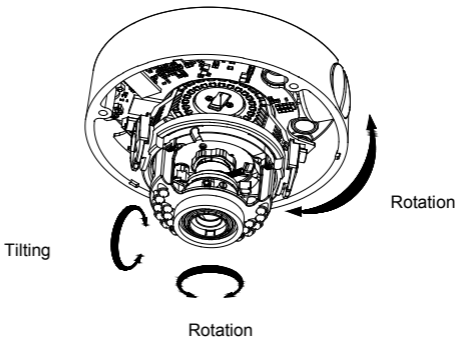

Mounting the IP mini dome camera

To mount the IP mini dome camera on a ceiling:

1. Drill the screw holes on the ceiling with the supplied drilling template. If you need to route the cables from the bottom of the camera, cut a cable hole in the ceiling.

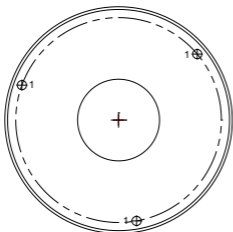

2. Using the supplied hex wrench, loosen the set screws to remove the dome enclosure.

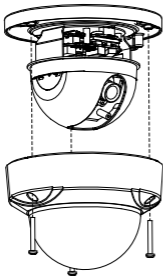

3. Fix the mounting base onto the ceiling with screws.

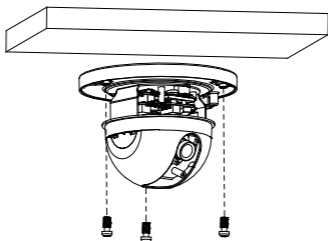

Note: If required, you can route cables through the side opening of the mounting base.

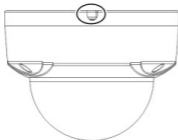

4. Loosen the tilt lock screws, and adjust the tilting position in a range of 65 degrees. Retighten the tilt lock screws.

Rotate the dome liner to adjust the panning position in a range of 360 degrees to obtain the desired surveillance angle.

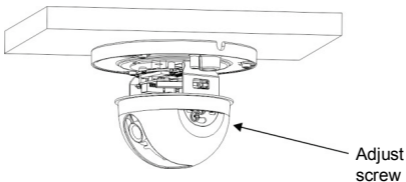

5. Reinstall the lower dome and tighten the screws.

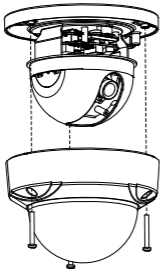

Mounting the IP wedge dome camera

To mount the IP wedge dome camera on a ceiling:

1. Drill the screw holes on the ceiling with the supplied drilling template. To route the cables from the base of the camera, cut a cable hole in the ceiling.
2. Fix the converter pan to the ceiling (optional).

Note: If required, you can remove the tabs (A) on the side of the converter pan to pass the cables through.

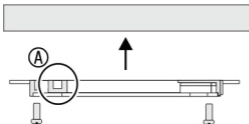

3. Loosen the set screws with a hex wrench (supplied) to remove the dome enclosure.

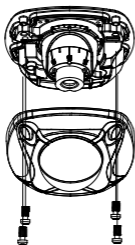

4. Fix the camera base to the converter pan or mounting surface.

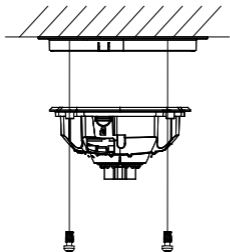

5. Use the supplied adjusting tool to adjust the pan [$\pm 30^\circ$], tilt [0 to 80°], and rotation direction [0 to 360°].

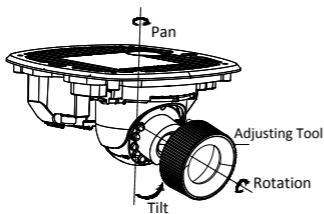

6. Re-attach the dome enclosure to the camera.

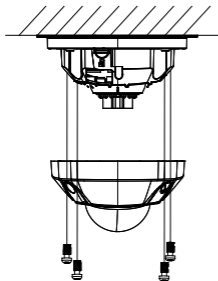

Using the camera with a recorder

Please refer to the recorder user manuals for instructions on connecting and operating the camera with these systems.

Using the camera with TruVision Navigator

A camera must be connected to an Interlogix NVR or hybrid DVR in order to be operated by TruVision Navigator. Please refer to the TruVision Navigator user manual for instructions on operating the camera with the TruVision Navigator.

Specifications

TruVision IP mini bullet cameras

Electrical

Voltage input	12 VDC, PoE (IEEE 802.3af)
---------------	----------------------------

Power consumption	Max. 5 W
-------------------	----------

Miscellaneous

Connectors	DC jack flying lead, RJ45 flying lead
------------	---------------------------------------

Operating temperature	-30 to +60 °C (-22 to 140°F)
-----------------------	------------------------------

Dimensions	Ø 60 × 153 mm (2.3" × 6.0")
------------	-----------------------------

Weight	373 g (0.82 lbs)
--------	------------------

Environmental rating	IP66
----------------------	------

TruVision IP VF bullet cameras

Electrical

Voltage input	12 VDC, PoE (IEEE 802.3af)
---------------	----------------------------

Power consumption	Max. 7.5 W
-------------------	------------

Miscellaneous

Connectors	DC jack flying lead, RJ45 flying lead
Operating temperature	-30 to +60 °C (-22 to 140°F)
Dimensions	Ø 104.8 × 255.6 mm
Weight	800 g
Environmental rating	IP66

TruVision IP mini dome

Electrical

Voltage input	PoE (IEEE 802.3af) PoE/12VDC(TVD-X105/X106)
Power consumption	Max. 5 W Max. 7 W (TVD-X105/X106)

Miscellaneous

Connectors	RJ45 flying lead
Operating temperature	-30 to +60 °C (-22 to +140 °F)
Dimensions (L × W × H)	Ø 111 × 82 mm (4.4" × 3.2")
Weight	370 g (0.81lbs)
Environmental rating	IP66

TruVision IP VF mini dome cameras

Electrical

Voltage input	12 VDC, PoE (IEEE 802.3af)
---------------	----------------------------

Power consumption	Max. 5.5 W
-------------------	------------

Miscellaneous

Connectors	DC jack flying lead, RJ45 flying lead
------------	---------------------------------------

Operating temperature	-30 to +60°C (-22°F to +140°F)
-----------------------	--------------------------------

Dimensions (L × W × H)	Ø 140 × 100 mm (Φ 5.51" × 3.94")
------------------------	----------------------------------

Weight	767 g (1.69 lb)
--------	-----------------

Environmental rating	IP66
----------------------	------

TruVision IP wedge cameras

Electrical

Voltage input	12 VDC, PoE (IEEE 802.3af)
---------------	----------------------------

Power consumption	Max. 5 W (Max. 7 W with IR on)
-------------------	--------------------------------

Miscellaneous

Connectors	DC jack flying lead, RJ45 flying lead
------------	---------------------------------------

Operating temperature	-30 to +60°C (-22°F to +140°F)
-----------------------	--------------------------------

Dimensions (L × W × H)	98 × 89 × 329 mm (3.86 × 3.49 × 12.94 in.)
------------------------	---

Weight	407 g (0.89 lb)
--------	-----------------

Environmental rating	IP66
----------------------	------

Pin definitions

There are eight wires on a standard UTP/STP cable and each wire is color-coded. The following shows the pin allocation and color of straight and crossover cable connection:

Figure 2: Straight-through cable

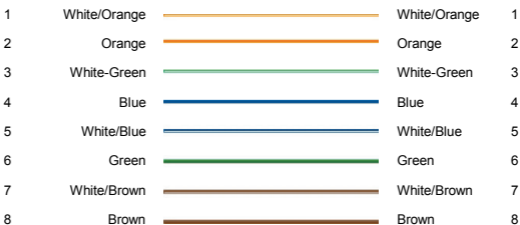
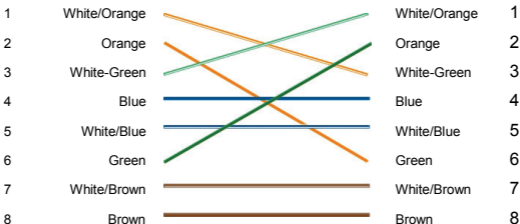

Figure 3: Cross-over cable



Please make sure your connected cables have the same pin assignment and color as above before deploying the cables in your network.

