

# TruVision High Definition TVI Bullet Camera Installation Guide

TVB-2402/TVB-4402

TVB-2404/TVB-4404



# Contents

Product overview	2
Camera description	4
Installation	6
Programming	9
Setup menus	13
Specifications	15
Legal and regulatory information	16

# Product overview

This is the TruVision High Definition TVI Bullet Camera Installation Guide for models TVB-2402/TVB-4402 and TVB-2404/TVB-2404. This guide describes a standard installation.

## Package contents:

- Camera with power and video output cables
- 4 screws and 4 anchors for wall or ceiling installation

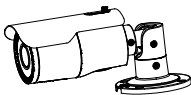

- Back box
- Screws M4.8 × 18, 4pcs to attach the back box



- Template



- WEEE and Battery Disposal

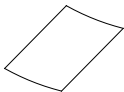

- Hex wrench

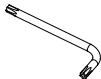

- CD



## Camera description

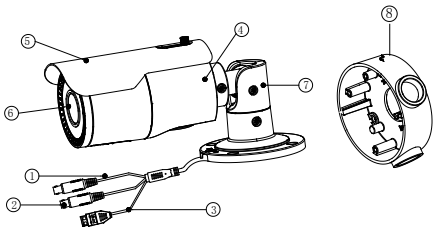

- |                              |                     |
|------------------------------|---------------------|
| 1. CVBS output cable (black) | 5. Sun shield       |
| 2. TVI output cable (grey)   | 6. Lens cover       |
| 3. Power cable               | 7. Mounting bracket |
| 4. Camera body               | 8. Back box         |

### Note:

Please check the camera output settings before setting up a system. The TVI video output can be only connected to DVR with TVI signal input. The

CVBS output supports the standard monitor, test monitor, encoder and DVR.

For TVB-2402 / TVB-4402, the CVBS and TVI output can not be performed at the same time, you can use the built-in DIP switch to select the camera video output.

For TVB-2404/TVB-4404, the built-in DIP switch is used to enable/disable WDR feature, when WDR feature is enabled, the CVBS output will be blocked out.

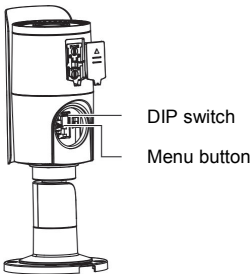

# Installation

## To install the camera:

1. Using the template, place it level against the mounting surface and mark the position of the mounting holes.

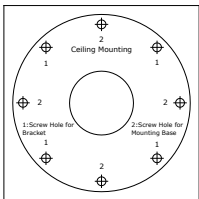

2. Following all local codes, drill and prepare the mounting holes.
3. (Optional) Install the back box on the wall.



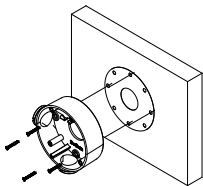

4. Route the cables to the cable hole and connect the corresponding cables. Using a 75-ohm coaxial video cable, connect the camera TVI video output and a TVI DVR, and connect a 12 VDC or 24 VAC power supply to the power cable.
5. Secure the camera to the ceiling or wall with the screws.

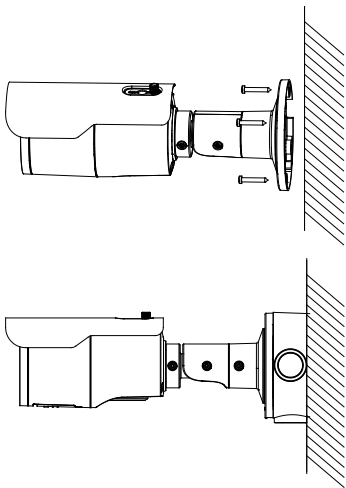

6. Loosen the three screws and adjust the camera according to the figure below to get an optimum angle. Tighten the screw after completing the adjustment.

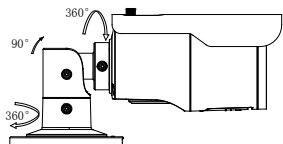

7. Loosen the three screws and adjust the camera according to the figure below to get an optimum angle. Tighten the screw after completing the adjustment.

## Programming

### Programming on TVI output:

Once the camera hardware has been installed, you can configure the camera settings on the TVI DVR.

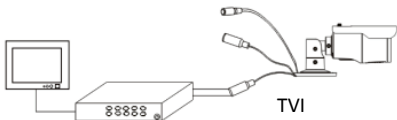

Select PTZ protocol as **TruVision Coax** and click menu button to call up the camera menu.

For more details, please see the TVI DVR user manual.

### **Programming on CVBS output:**

The camera can then be configured by using the built-in OSD button or a TVS-C200 controller (purchase separately).

Please connect a monitor and the TVS-C200 (if needed) controller as following system figure.

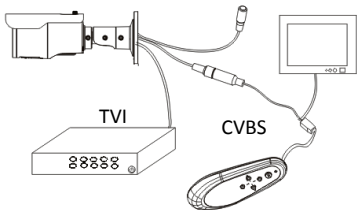

## **TVB-2402/TVB-4402**

The camera has CVBS and TVI selectable video output. Set the built-in DIP switch to CVBS for viewing the program on a standard monitor.

The TVI is blocked out until you finish the settings and change the DIP switch back to TVI.

## **TVB-2404/TVB-4404**

The camera has the CVBS and TVI dual video output. The built-in DIP switch is for WDR/CVBS selection.

Please set the built-in DIP switch to CVBS for viewing the program on a standard monitor.

When the programming is finished, you may change the DIP to WDR to enable the WDR feature. In such case, the CVBS output will be blocked out.

If the DIP is set as CVBS, the WDR feature will be disabled, and the camera has CVBS and TVI output available at the same time

# Setup menus

## TVB-2402/TVB-4402

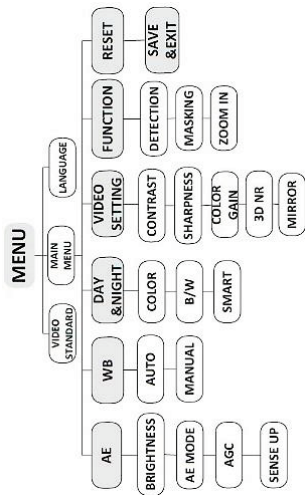

# TVB-2404/TVB-4404

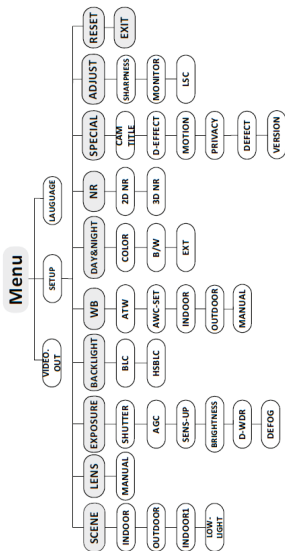



## Specifications

---

Power supply	12 VDC / 24 VAC
Current	<b>TVB-2402 / TVB-4402:</b> 12 VDC: Max. 333 mA 24 VAC: Max. 250 mA <b>TVB-2404/TVB-4404:</b> 12 VDC: Max. 420 mA 24 VAC: Max. 250 mA
Power consumption	<b>TVB-2402/TVB-4402:</b> 12 VDC: Max. 4W 24 VAC: Max. 6W <b>TVB-2404/TVB-4404:</b> 12 VDC: Max. 5W 24 VAC: Max. 6W
Weight (net)	860 g / 1.89 lb. (without back box) 1075 g / 2.36 lb. (with back box)
Dimensions	105 × 94.7 × 265.4 mm / 4.13 × 3.74 × 10.4 in. (without back box ) 105 × 94.7 × 301.4 mm / 4.13 × 3.74 × 11.86 in. (with back box)

---

# Legal and regulatory information

## Copyright:

© 2015 United Technologies Corporation,  
Interlogix is part of UTC Building & Industrial Systems, a unit of  
United Technologies Corporation. All rights reserved.

## Trademarks and patents:

Trade names used in this document may be trademarks or registered trademarks of the manufacturers or vendors of the respective products.

## Manufacturer:

Interlogix  
2955 Red Hill Avenue, Costa Mesa, CA 92626-5923, USA  
Authorized EU manufacturing representative:  
UTC Fire & Security B.V.  
Kelvinstraat 7, 6003 DH Weert, The Netherlands

## Certification:



## FCC compliance: Class A

Class A: This equipment has been tested and found to comply with the limits for a Class A digital device, pursuant to part 15 of the FCC Rules. These limits are designed to provide reasonable protection against harmful interference when the equipment is operated in a commercial environment. This equipment generates, uses, and can radiate radio frequency energy and, if not installed and used in accordance with the instruction manual, may cause

harmful interference to radio communications. Operation of this equipment in a residential area is likely to cause harmful interference in which case the user will be required to correct the interference at his own expense.

### **ACMA compliance**

Notice! This is a Class A product. In a domestic environment this product may cause radio interference in which case the user may be required to take adequate measures.

### **Canada**

This Class A digital apparatus complies with Canadian ICES-003. Cet appareil numérique de la classe A est conforme à la norme NMB-0330 du Canada.

### **European Union directives:**

**12004/108/CE (EMC directive):** Hereby, UTC Fire & Security declares that this device is in compliance with the essential requirements and other relevant provisions of Directive 2004/108/EC.



**2012/19/EU (WEEE directive):** Products marked with this symbol cannot be disposed of as unsorted municipal waste in the European Union. For proper recycling, return this product to your local supplier upon the purchase of equivalent new equipment, or dispose of it at designated collection points. For more information see: [www.recyclethis.info](http://www.recyclethis.info).

### **Contact information:**

For contact information, see [www.interlogix.com](http://www.interlogix.com) or [www.utcssecurityproducts.eu](http://www.utcssecurityproducts.eu)

