

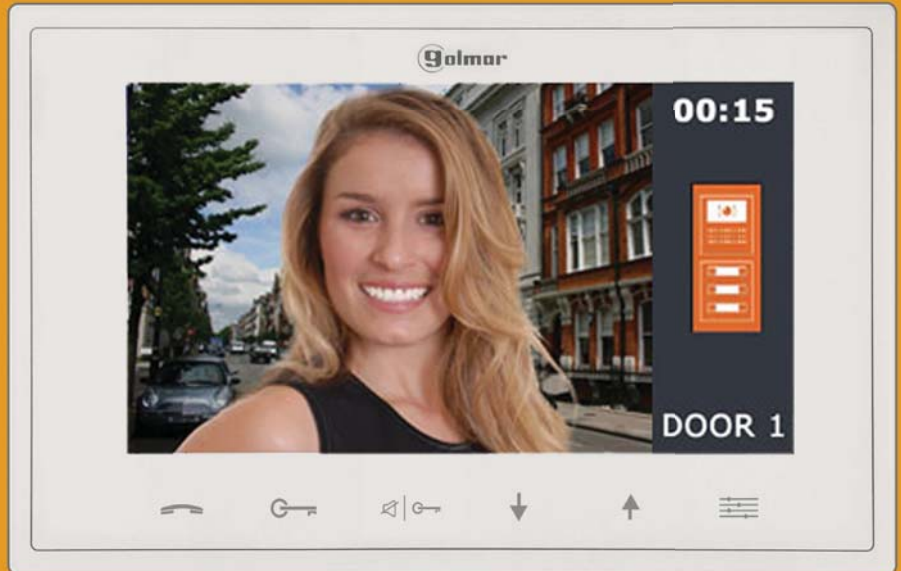

42 Central Drive - Farmingdale NY 11735-1202
P: 631-777-5500 | F: 631-777-5599

USER MANUAL



VESTA7 GB2 MONITOR

info@alphacommunications.com | <http://alphacommunications.com>



INTRODUCTION

First and foremost we would like to thank you for purchasing this product.

Our commitment to achieving the satisfaction of customers like you is manifested through our ISO-9001 certification and the manufacture of products like the one you have just purchased.

Its advanced technology and strict quality control will ensure that customers and users enjoy the numerous features that this device offers. To get the most out of them and ensure proper operation from day one, we recommend that you read this instruction manual.

CONTENTS

Introduction..... 2

Contents..... 2

Safety precautions..... 2

Characteristics..... 3

System operation..... 3

Description of the monitor.....

 Description..... 4

 Function and menu buttons..... 4

 Connection terminals..... 4

 Configuration DIP switch..... 4

 Setting the monitor's address codes..... 5

Installing the monitor in a wall mounting connector..... 6

Installing the monitor in an embedding box..... 7

Operation.....

 Description and communication with hearing aids (Vesta7 GB2/H monitor only)..... 8

 1.1 Receiving a call from the door panel..... 8

 1.2 Call not answered (missed call)..... 9

 1.3 Ending a call from the door pane..... 9

 1.4 Answering a call from the door panel..... 9

Monitor screen and volume settings menu (brightness, colour, contrast and communication volume)..... 10

User direct access functions..... 11

 1. Displaying door panel/camera images..... 11-12

 2. Activating the outdoor light..... 12

 3. Activating 'Do not disturb' mode..... 13

 4. Intercom within an apartment..... 13-14

User menu.....

 Accessing the menu..... 15

 1. Displaying door panel/camera images..... 16

 2. Activating the outdoor light..... 17

 3. Intercom between apartments..... 17-18

 4. Exiting the menu..... 18

 5. About (information and installer setup)..... 19-20

 6. Settings (ringtone, ringtone volume, default settings and language selection)..... 20-22

Cleaning the monitor..... 22

Notes..... 23











SAFETY PRECAUTIONS

- Avoid overtightening the screws of the monitor's wall mounting connector.
- **Always disconnect the power supply** before making modifications to the device.
- The fitting and handling of these devices must be carried out by **authorised personnel**.
- All of the wiring must run at least **40cm away from any other wiring**.
- Install the monitor in a dry protected location free from the risk of dripping or splashing water.
- Do not place in humid, dusty or smoky locations, or near sources of heat.
- Before connecting the system to the mains, check the connections between the door panel, power supply, distributors and monitors.
- Always follow the instructions contained in this manual.

CHARACTERISTICS

- Hands-free monitor.
- 7" TFT colour screen.
- Monitor with simple installation (non-polarised 2 wire BUS).
- The VESTA7 GB2/H monitor interacts with hearing aids equipped with T-mode, making conversation between the door panel and apartment easier.
- Capacitive function buttons to access and select menu functions:
 - User menu:**
 - Displaying the door panel image.
 - Displaying the camera image (DQ-CAM-GB2 module required).
 - Activating the outdoor light.
 - Intercom between apartments.
 - About: Information and access to installer setup.
 - Settings: Ringtone, ringtone volume, default settings (restore) and language.
 - Installer setup:**
 - Monitor as master or slave 1, slave 2 or slave 3. Up to 4 monitors per apartment.
 - Indicating the number of door panels (up to 4 access panels).
 - Indicating the number of cameras (up to 4 CCTV cameras, DQ-CAM-GB2 module required).
 - Enabling the menu to be viewed when the Bus is busy.
 - Activating intercom between apartments.
 - Screen and volume settings menu:** (during auto switch-on or communication).
 - Brightness.
 - Colour.
 - Contrast.
 - Monitor speaker volume (communication).
- Start/stop communication button and, in standby mode, it displays the image from the door panel.
- Door release button 1 / in standby, it activates the outdoor light.
- Door release button 2 / in standby, it activates/deactivates the 'do not disturb' function.
- Intercom within apartment button.
- Menu access button.
- Monitor status LEDs.
- Different ringtones to identify the origin of the call (door panel, intercom or apartment door).
- DIP switches for setting the monitor address (call code) and end of line.
- Input for call from the apartment door.
- SAR-12/24 call repeater output (12Vdc/50mA maximum).

SYSTEM OPERATION

- To make a call, the visitor must press the button of the apartment; an audible sound indicates that the call is being made and LED  will turn on. If vocal synthesis is enabled, a 'Call is in progress' message appears indicating that a call is being made. At this moment, the apartment's monitors receive the call. If another apartment is called by mistake, press the button for the correct apartment and the first call will be cancelled.
- The ring tone lasts for 40 seconds. Without alerting the visitor, their image appears on the master monitor during this time. To view the picture on a slave monitor this function must first be activated in the monitor. House kit application: the image appears on the monitor (with code 0 "apartment 1" or monitor with code 16 if the call is in "apartment 2") when receiving the call without the visitor being alerted.
If the call is not answered within 40 seconds, LED  will turn off and the channel will be freed.
- To establish communication, press button  on any monitor in the apartment. Door panel LED  will turn on.
If the monitor is a VESTA7 GB2/H with icon  on the front, make sure that the hearing aid is 20 cm away from the monitor to ensure maximum audio quality during communication with the door panel.
- Communication will last for one and a half minutes or until button  or  is pressed again. When communication has finished, LEDs  and  will turn off and the channel will be freed. If vocal synthesis is activated, a 'Communication is finished' message will indicate that the call is over.
- To open door 1 or 2, press the corresponding button  during the call or communication processes: one press will activate the lock release for five seconds and LED  will also turn on for five seconds. If vocal synthesis is enabled, a 'Door Opened!' message will be indicated on the door panel.
- Descriptions of the function push buttons can be found on p. 4.

DESCRIPTION OF THE MONITOR

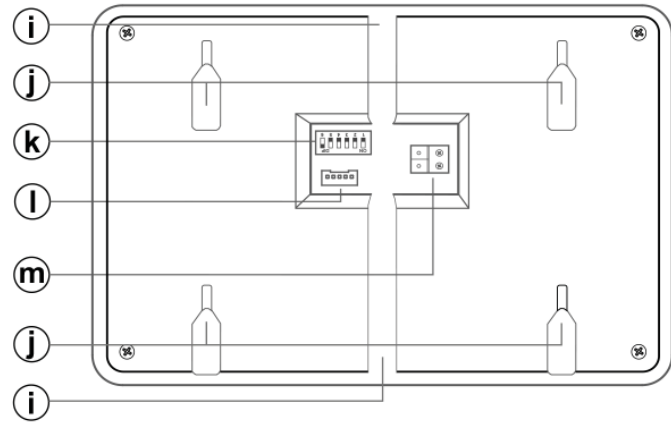
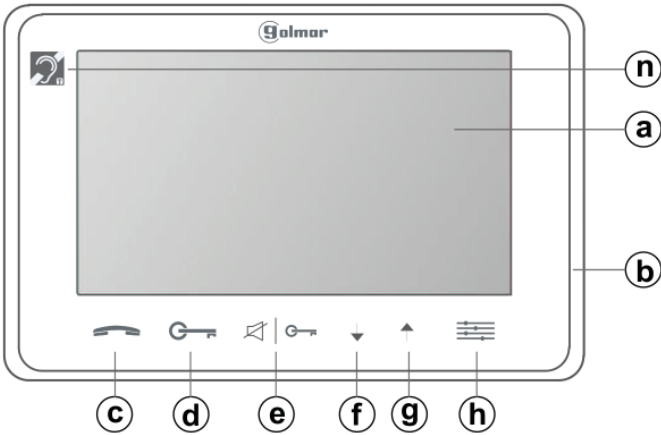

- a. 7" TFT colour screen.
- b. Microphone.
- c. Start/stop communication button.
In standby: Display door panel image.
- d. Door release button 1. In standby: Activate out. light.
- e. Door release button 2. In standby: 'do not disturb' mode, if the mode is activated, the icon illuminates.
- f..End call/communication button.
In standby, intercom within apartment function.
In auto spy/auto switch-on: Select other door panel(s), camera(s) in descending mode and in carousel (if any).
- g. In standby: Enter menu. (continued)

- In auto spy/auto switch-on: Select other door panel(s), camera(s) in ascending mode and in carousel (if any).
In call/communication: select camera(s) in ascending mode and in carousel (if any).
- h. In standby: enter menu.
Video activated: screen and communication volume settings.
- i. Vertical wiring entry.
- j. Connector fixings.
- k. Configuration DIP switch.
- l. Connector.
- m. Bus connection terminals.
- n. Communication with hearing aids (Vesta7 GB2/H only)
Set the hearing aid switch to T-mode, see p. 8.

Menu buttons:

- Menu entry and user settings button.
- Menu screen exit and selection button.
- Menu entry and selection button.

- On menu screen: Display door panel image.
- On menu screen: Activate outdoor light.
- On menu screen: Intercom function between apartments.

Connection terminals and DIP switch:

Connection terminals:

- L1, L2: Bus connection (non-polarised).
- HZ+, HZ-: Door bell connection.
- CALL REPEATER, GND: Call repeater connection (SAR-12/24). (12Vdc/50mA maximum).

Configuration DIP switch:

- DIP6: Sets the end of line. Set to ON in monitors where the bus cable terminates. Set to OFF only in intermediate monitors.
- DIP1 to DIP5: To set the monitor address (addresses 0 to 31).

The switches set to OFF have a zero value.
The values of the switches set to ON are shown in the table below.
The monitor code is the sum of the values of the switches set to ON.

Value chart

Switch number:	1	2	3	4	5
Value when ON:	1	2	4	8	16



Example: 0 + 0 + 4 + 0 + 16 = 20

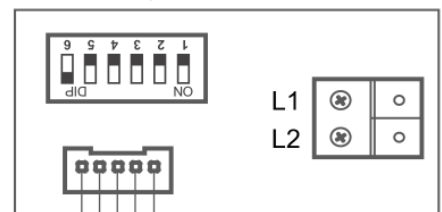
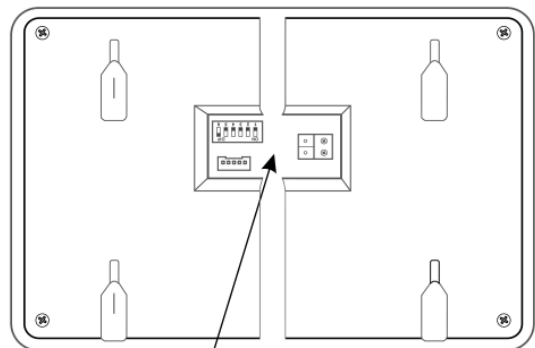

- (YELLOW): DO NOT USE
- (BLACK): GND
- (RED): CALL REPEATER
- (GREEN): HZ-
- (WHITE): HZ+

DESCRIPTION OF THE MONITOR

Setting the monitor's address codes (addresses 0 to 31):

DIP6: Sets the end of line. Set to ON in monitors where the video cable terminates. Set to OFF only in intermediate monitors.

Dip6 to ON



Dip6 to OFF



DIP1 to DIP5: To set the monitor address (addresses 0 to 31).

Code 0 / 32 (*)



Code 08



Code 16



Code 24



Code 01



Code 09



Code 17



Code 25



Code 02



Code 10



Code 18



Code 26



Code 03



Code 11



Code 19



Code 27



Code 04



Code 12



Code 20



Code 28



Code 05



Code 13



Code 21



Code 29

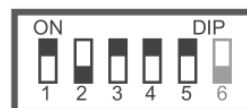

Code 06



Code 14



Code 22

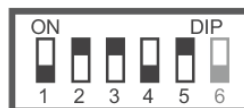

Code 30



Code 07



Code 15



Code 23



Code 31



(*) **Important:**

-In door panel systems with call pushbuttons, the first address on the monitor is 'Code 0'.

-In coded panel systems (N3301/GB2), 'Code 0' is 'Code 32', which means that when a call is made to a monitor with 'Code 0' (DIP 1 to DIP 5 set to OFF), **3 2** needs to be entered on the N3301/GB2 numeric keypad.

-In the software (Address Manager GB2), 'Code 0' is also shown as 'Code 32'.

INSTALLING THE MONITOR IN A WALL MOUNTING CONNECTOR

Avoid dusty or smoky environments or locations near sources of heat.

Positioning the wall mounting connector:

The top of the connector must be positioned at a height of 1.60m. The minimum distance between the sides of the connector and the closest object must be 5cm.

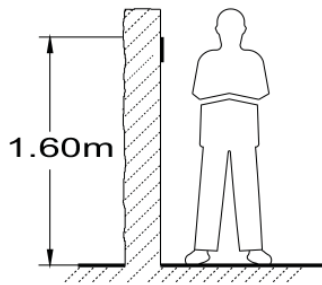

Fixing the monitor's wall mounting connector to the wall:

Fix the monitor's wall mounting connector to the wall by drilling two 6mm diameter holes and using the screws and plugs supplied with the monitor.

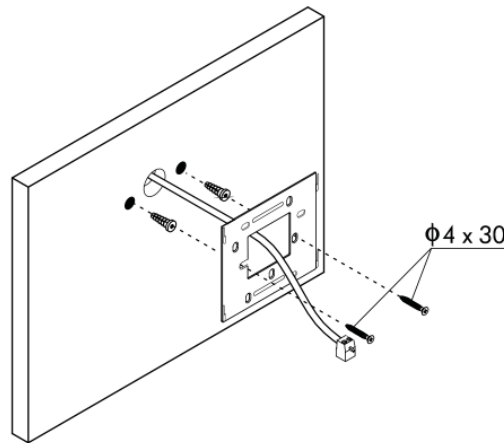

Positioning the monitor:

Connect the cables to the monitor (see p. 4), position the monitor in front of the wall mounting connector, ensuring that the holes in the base of the monitor line up with those on the connector ①, and then move the monitor downwards ② until the monitor is securely fixed to the connector ③.

Remember to remove the protective covering from the front of the monitor once installation is complete.

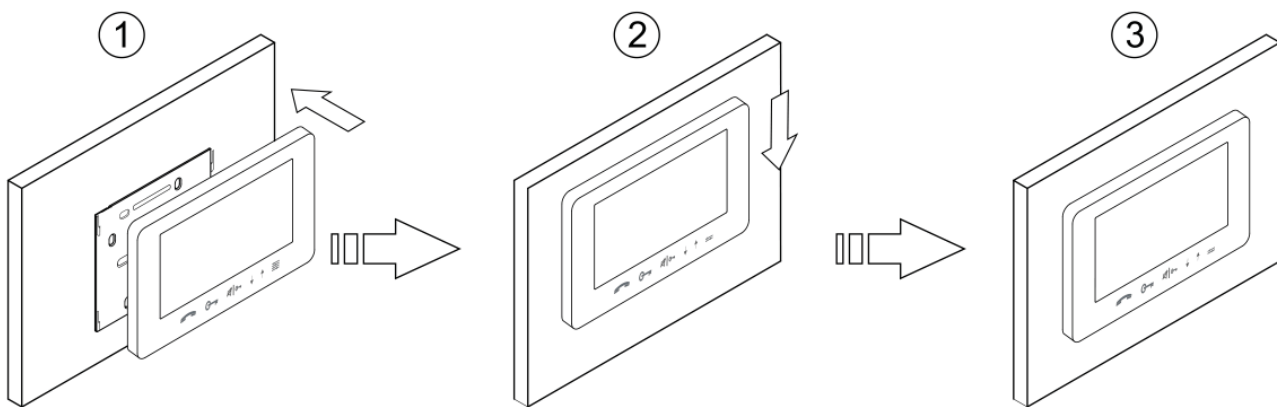

INSTALLING THE MONITOR IN AN EMBEDDING BOX

Avoid dusty or smoky environments or locations near sources of heat.

Positioning the embedding box:

Make a hole in the wall to position the top of the universal embedding box at a height of 1.60 m from the ground. The minimum distance between the sides of the embedding box and the closest object must be 5cm.

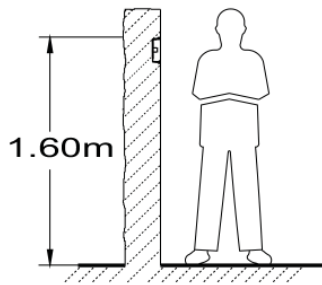

Positioning the embedding box and fitting the wall mounting connector:

Pass the cable through the hole made in the embedding box. Embed the box and ensure that it is level and flush. Fix the wall mounting connector of the monitor to the embedding box with the screws supplied.

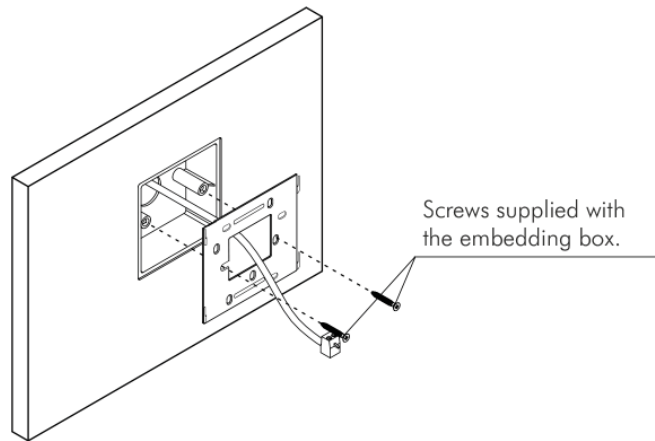

Positioning the monitor:

Connect the cables to the monitor (see p. 4), position the monitor in front of the wall mounting connector, ensuring that the holes in the base of the monitor line up with those on the connector ①, and then move the monitor downwards ② until the monitor is securely fixed to the connector ③.

Remember to remove the protective covering from the front of the monitor once installation is complete.

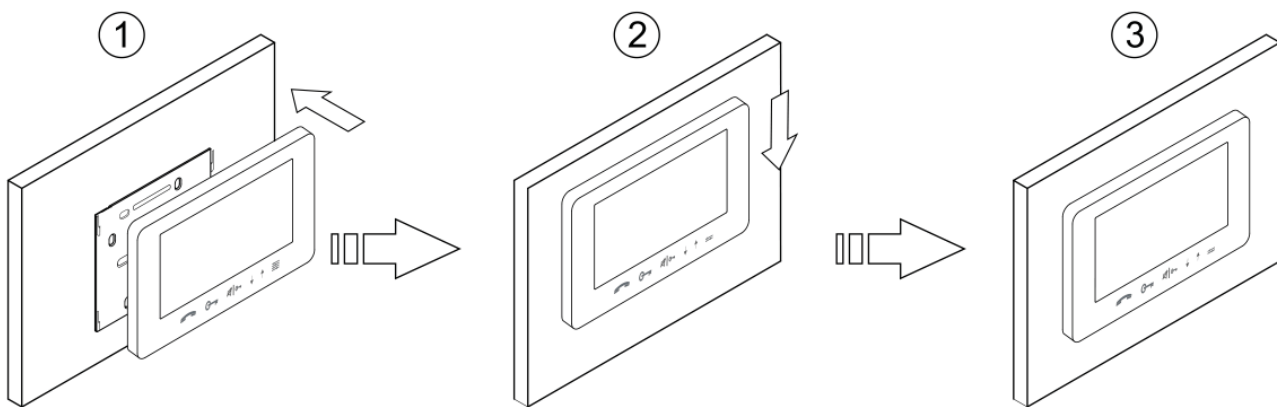

OPERATION

Monitor description when receiving a call and during communication:

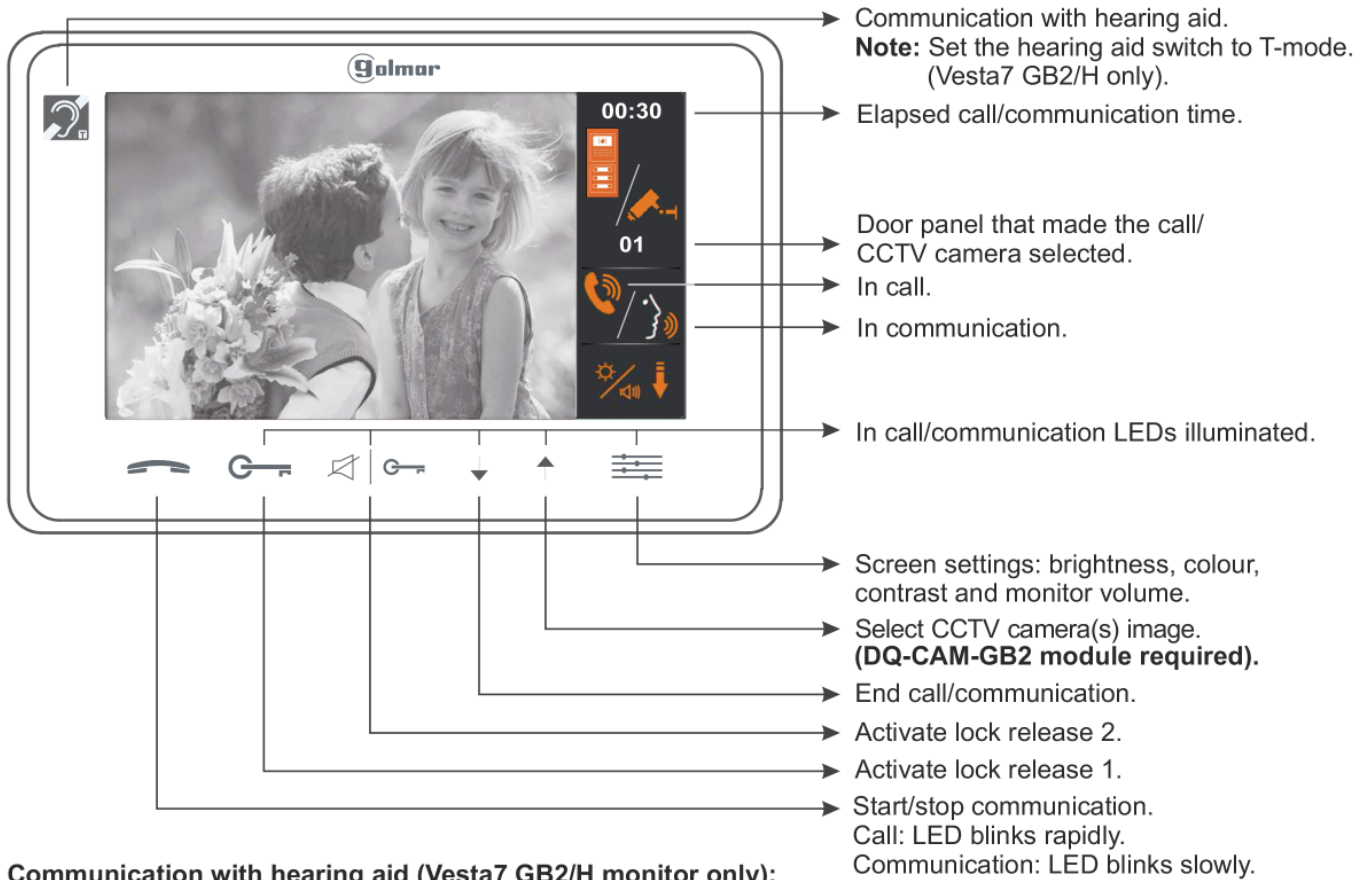

Communication with hearing aid (Vesta7 GB2/H monitor only):

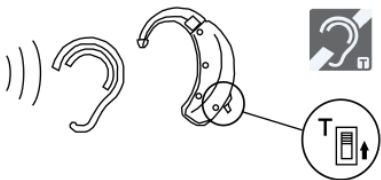

Make sure that the hearing aid is 20 cm away from the monitor to ensure maximum audio quality during communication with the door panel.

1.1 Receiving a call from the door panel:

When a call is received, the monitor(s) will play a melody, the LEDs will illuminate (the LED of button will blink rapidly) and the image from the door panel will be displayed on the master monitor without the visitor knowing. If the call is not answered within 40 seconds the monitor returns to standby mode.



To open door 1, press the door release button during the call: one press will activate the lock release for 5 seconds.

To open door 2, press the door release button during the call: one press will activate the lock release for 5 seconds.

OPERATION



Continued from previous page.



1.2 Call not answered (missed call):

When a call is received, the monitor(s) will play a melody, the LEDs will illuminate (the LED of button  will blink rapidly) and the image from the door panel will be displayed on the master monitor without the visitor knowing. If the call is not answered within 40 seconds the monitor returns to standby mode.





1.3 Ending a call from the door panel:

When a call is received, the monitor(s) will play a melody, the LEDs will illuminate (the LED of button  will blink rapidly) and the image from the door panel will be displayed on the master monitor without the visitor knowing. To end the call, press button .

To open door 1 or 2, press the corresponding button  /  during the call process: one press will activate lock release 1 or 2 for five seconds.









 To open door 1, press the door release button during the call: one press will activate the lock release for 5 seconds.



 To open door 2, press the door release button during the call: one press will activate the lock release for 5 seconds.

 End call.

1.4 Answering a call from the door panel:

When a call is received, the monitor(s) will play a melody, the LEDs will illuminate (the LED of button  will blink rapidly) and the image from the door panel will be displayed on the master monitor without the visitor knowing. To answer the call, press button  (the LED of button  will blink slowly). If the monitor is a VESTA GB2/H with icon  on the front, make sure that the hearing aid is 20 cm away from the monitor to ensure maximum audio quality during communication with the door panel.

Communication will last for one and a half minutes or until button  or  is pressed again.

To open door 1 or 2, press the corresponding button  /  during the call or communication processes: one press will activate lock release 1 or 2 for five seconds.



 Start/stop communication.

 To open door 1, press the door release button during the call: one press will activate the lock release for 5 seconds.

 To open door 2, press the door release button during the call: one press will activate the lock release for 5 seconds.

SCREEN AND VOLUME SETTINGS MENU

To adjust brightness, the monitor must be in communication or auto switch-on mode. Then press button to display option . Using menu buttons and , select the required brightness level. Press button to change the following option or press to exit the settings menu.

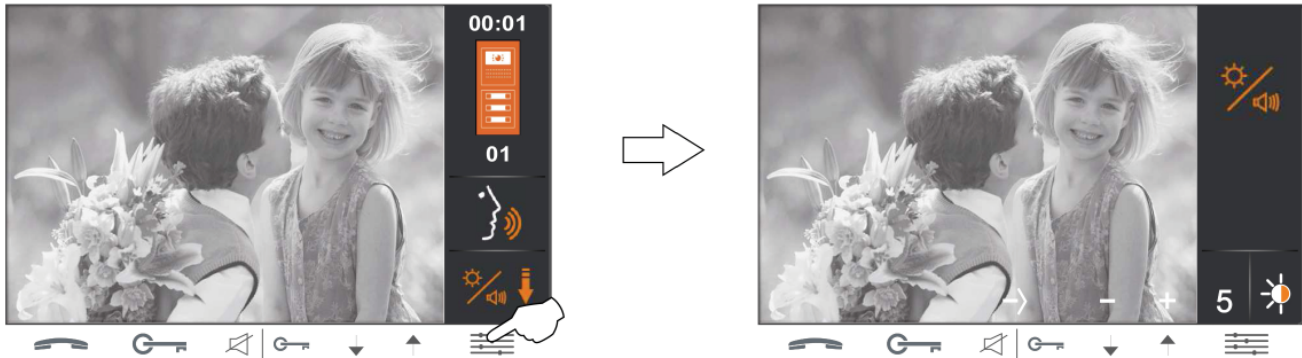

To adjust the colour, the monitor must be in communication or auto switch-on mode. Then press button repeatedly until option is displayed on the screen. Using menu buttons and , select the required colour level. Press button to change the following option or press to exit the settings menu.

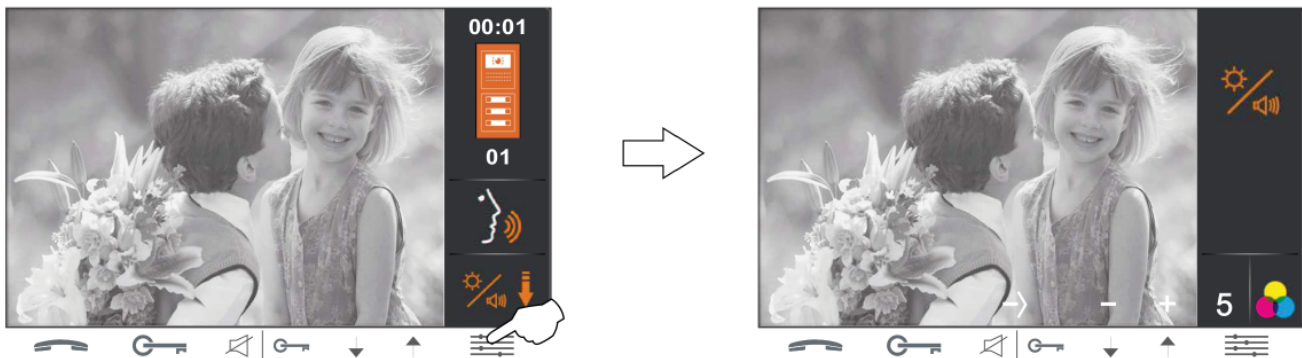

To adjust the contrast, the monitor must be in communication or auto switch-on mode. Then press button repeatedly until option is displayed on the screen. Using menu buttons and , select the required contrast level. Press button to change the following option or press to exit the settings menu.

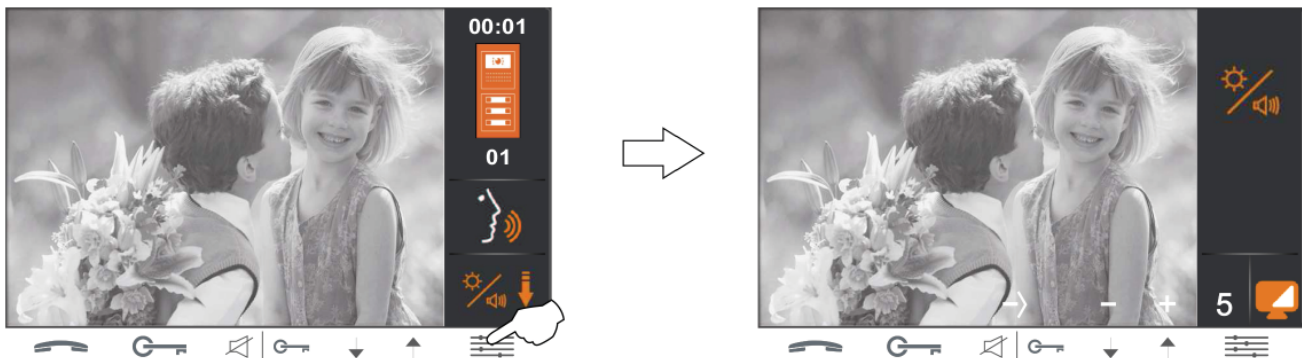

To adjust the communication volume, the monitor must be in communication or auto switch-on mode. Then press button repeatedly until option is displayed on the screen. Using menu buttons and , select the required volume level. Press button to return to option or press to exit the settings menu.



USER DIRECT ACCESS FUNCTIONS

Description of buttons with user direct access functions:



 Display door panel image.

 Activate intercom function within apartment.

 Activate outdoor light.

 Activate/deactivate 'Do not disturb' mode function.

1. Displaying door panel/camera images:

1.1 To display the image from one of the installed door panels/cameras, press button  while the monitor is in standby. The following screen will display the image from the door panel with address 1, indicating the selected door panel '01' and the elapsed connection time.

Monitor in standby

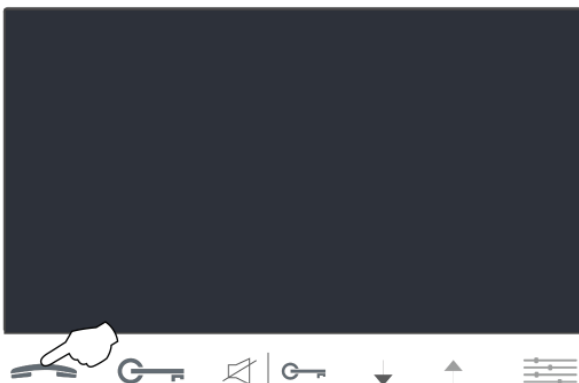

Door panel selected

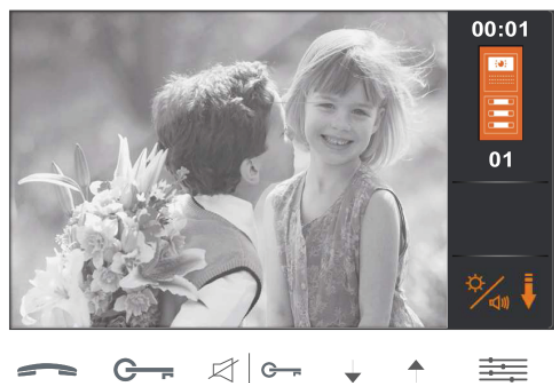

USER DIRECT ACCESS FUNCTIONS

Continued from previous page.

Then, using menu buttons ↓ and ↑, select the required door panel/camera (DQ-CAM-GB2 module required) in descending and ascending mode respectively (carousel mode).

The connection will last for 30 seconds or until option ☞ is pressed twice if a door panel is selected or once if a camera is selected.

During door panel selection, door 1 and 2 can be opened by pressing the corresponding button ☞ / ☞|☞ : one press will activate lock release 1 or 2 for five seconds.

Door panel selected

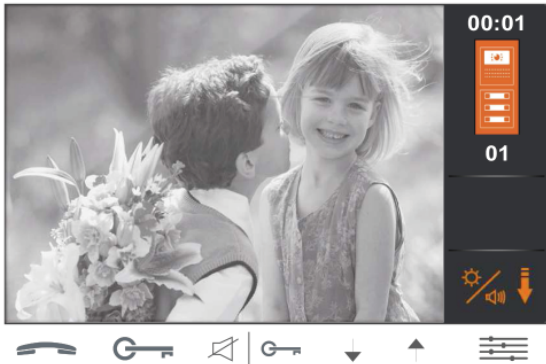

Camera selected

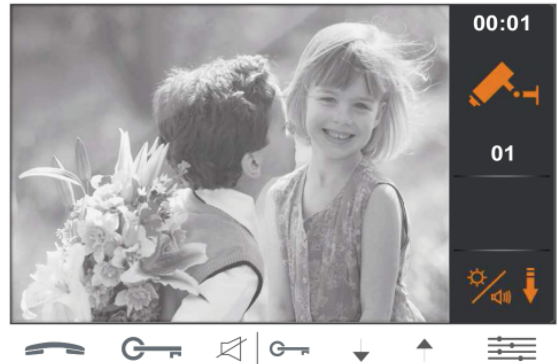

To establish audio and video communication with the selected door panel, press button ☞ . The screen will display symbol ☞|☞ . Communication will last for one and a half minutes or until button ☞ is pressed again.

During door panel selection, door 1 and 2 can be opened by pressing the corresponding button ☞ / ☞|☞ during the image display or communication processes: one press will activate lock release 1 or 2 for five seconds.



2. Activating the outdoor light:

2.1 To activate the outdoor light, press button ☞ while the monitor is in standby. The outdoor light (SAR-GB2 module required) activates for 1 minute. See the “TSAR-GB2 ML” user manual for how to set other light activation times.



Monitor in standby



USER DIRECT ACCESS FUNCTIONS



Continued from previous page.

3 Activating 'Do not disturb' mode:



3.1 To activate 'Do not disturb' mode, press button  on the master monitor while in standby. The status LED of button  of the master and secondary monitors in the apartment will illuminate indicating that the function is activated. The monitors in the apartment will not receive door panel or intercom calls.

Monitor in standby



3.2 To deactivate 'Do not disturb' mode, press button  on the master monitor while in standby. The status LED of button  of the master and secondary monitors in the apartment will turn off indicating that the function is deactivated.

4 Intercom within an apartment:

4.1 To activate the intercom within an apartment, press button  on the monitor while in standby. The following call screen will be displayed, the status LED of button  will blink rapidly and a long audible tone will confirm that the call is being made or short tones will indicate that a monitor in the apartment is already communicating with the door panel and the call will not be made. If a call is being made, press button  to cancel the call.

Monitor in standby

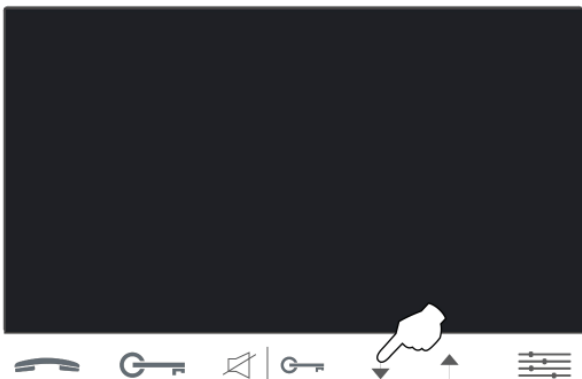



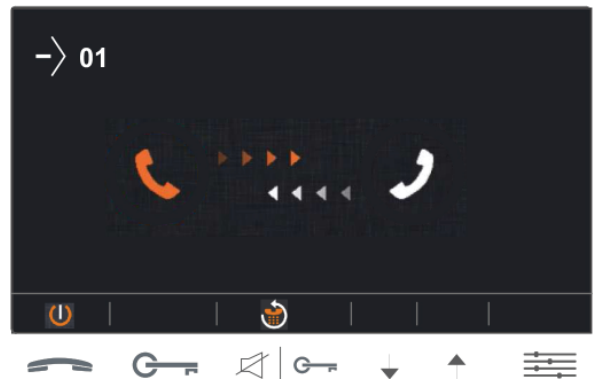

Making an intercom call



USER DIRECT ACCESS FUNCTIONS

Continued from previous page.

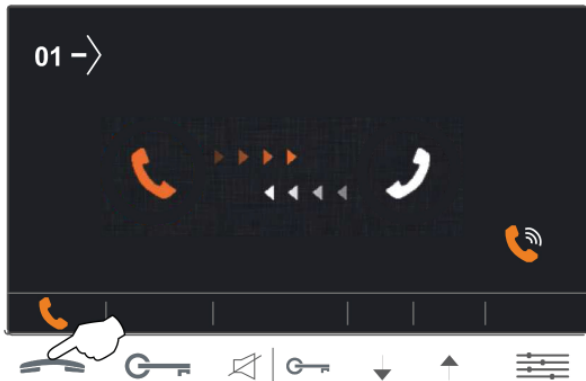

On the other monitors in the apartment, the status LED of button  will blink rapidly and a melody will indicate that an intercom call is being made. Press button  to accept the call and establish communication, the status LED of button  will blink slowly, or press button  to cancel it. If the call is accepted, communication will last for one and a half minutes or until button  is pressed again.

Receiving an intercom call

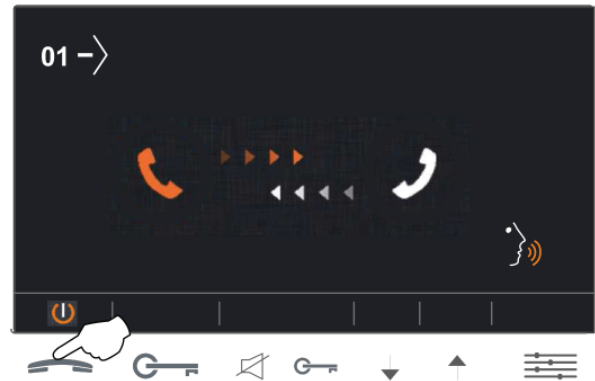

In communication



If during the intercom process a call is received from the door panel of another apartment, the intercom process will be cancelled; the monitor in the apartment will emit a melody to indicate that the call is being made and the image will appear on the master monitor. To establish communication with the door panel, press button  on the monitor. If there are slave monitors in the apartment, press button  on any of them.







If during the intercom process a call is received from another apartment, the intercom process will be cancelled; the monitor in the apartment will emit a melody to indicate that the call is being made and the address of the apartment making the intercom call will be displayed (see 'Intercom between apartments' on page 17-18).



The ringtones vary depending on where the call is being made from, enabling the user to identify its origin (door panel, intercom or apartment door).

USER MENU

Description of the menu buttons:



- | | |
|--|---|
|  Menu entry and user settings button. |  Display door panel image. |
|  Menu screen exit and selection button. |  Activate outdoor light. |
|  Menu entry and selection button. |  Intercom function between apartments. |

To access the menu, the monitor must be in standby. Then press menu button  or  to display the options screen of the main menu.

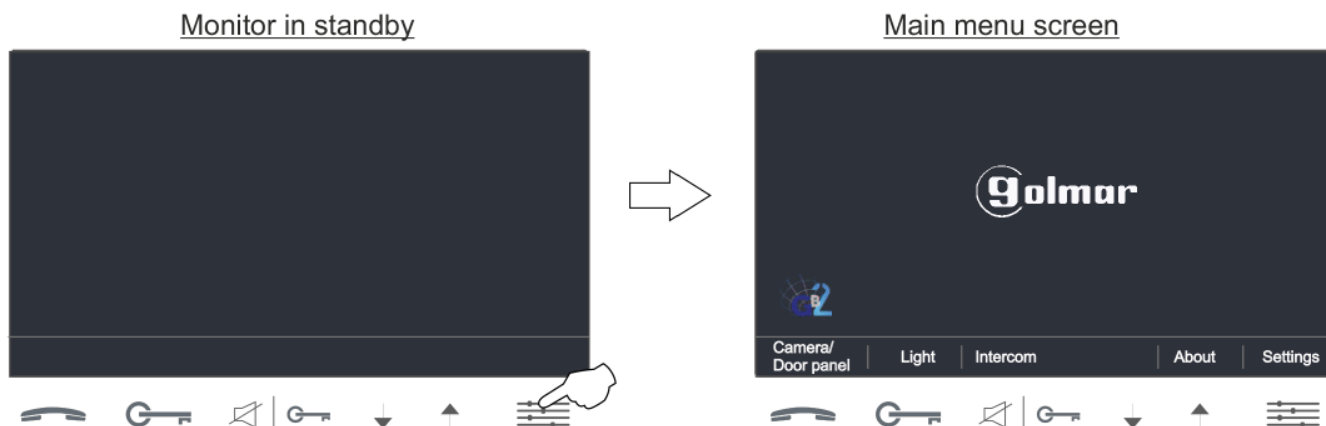

USER MENU

Continued from previous page.

1. Displaying door panel/camera images:

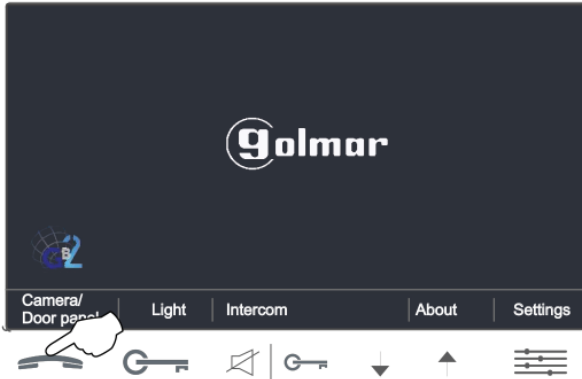

To display the image from one of the installed door panels/cameras, press button .

Main menu screen



The following screen will display the image from the door panel with address 1, indicating the selected door panel '01' and the elapsed connection time. Then, using menu buttons  and , select the required door panel/camera (DQ-CAM-GB2 module required) in descending and ascending mode respectively (carousel mode).

The connection will last for 30 seconds or until option  is pressed twice if a door panel is selected or once if a camera is selected.



During door panel selection, door 1 and 2 can be opened by pressing the corresponding button  /  : one press will activate lock release 1 or 2 for five seconds.

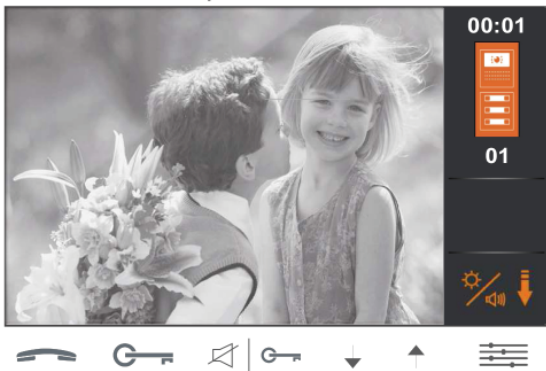

Door panel selected

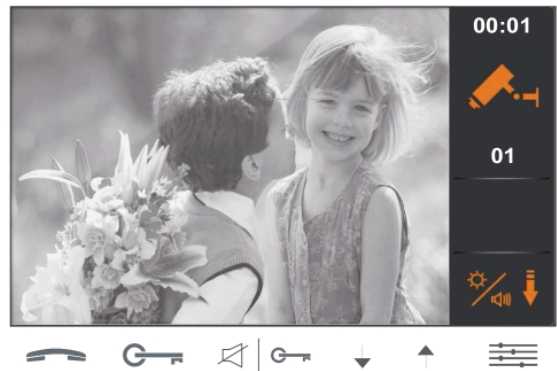

Camera selected



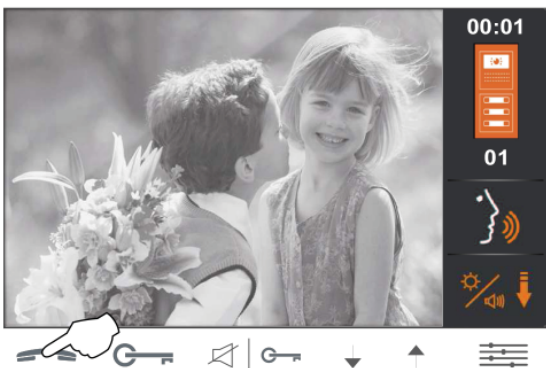

To establish audio and video communication with the selected door panel, press button . The screen will display symbol . Communication will last for one and a half minutes or until button  is pressed again.

During door panel selection, door 1 and 2 can be opened by pressing the corresponding button  /  during the image display or communication processes: one press will activate lock release 1 or 2 for five seconds.



 Start/stop communication.

 To open door 1, press the door release button during the call: one press will activate the lock release for 5 seconds.

 To open door 2, press the door release button during the call: one press will activate the lock release for 5 seconds.

USER MENU

Continued from previous page.



2. Activating the outdoor light:

To activate the outdoor light, press button . The outdoor light (SAR-GB2 module required) will activate for 1 minute. See the "TSAR-GB2 ML" user manual for how to set other light activation times.

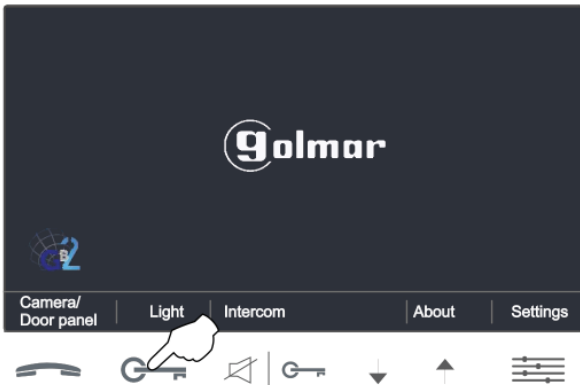
Main menu screen



3. Intercom between apartments:

To access the intercom function within an apartment, press button . The following selection screen will be displayed. Use buttons  and  to select the apartment to call.

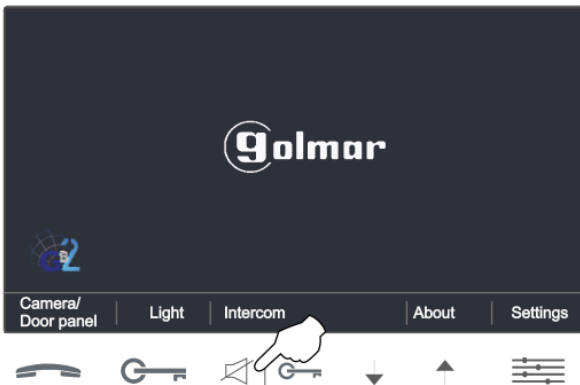

IMPORTANT: Activate function codes [9015] and [8017] on the monitor (see 'Installer setup' on pages 19-20).

Main menu screen



Apartment selection screen



Then press button  to make the call. The following call screen will be displayed indicating the address of the apartment to call. The status LED of button  will blink rapidly and a long audible tone will confirm that the call is being made or a series of short audible tones will indicate that the unit called is in communication with the door panel or on an intercom call with another apartment, and the call will not be made. If a call is being made, press option  to cancel the call.

Apartment selection screen





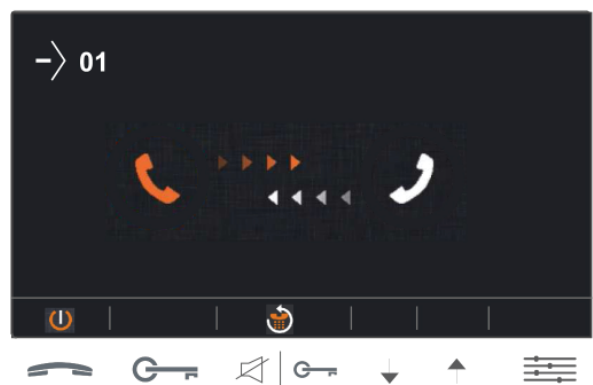

Making an intercom call



USER MENU

Continued from previous page.

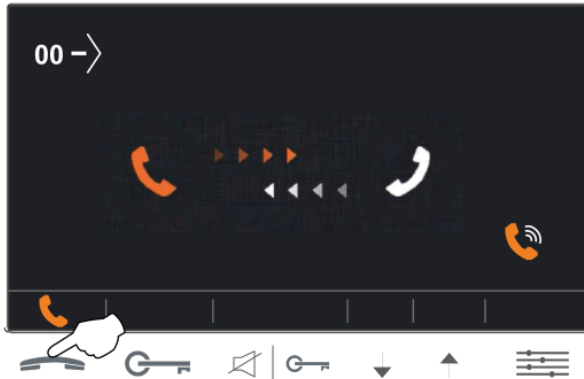

On the monitor(s) of the apartment called, the status LED of button  will blink rapidly, a melody will indicate that an intercom call is being made and the address of the apartment making the call will be shown. Press button  to accept the call and establish communication, the status LED of button  will blink slowly, or press button  to cancel it. If the call is accepted, communication will last for one and a half minutes or until button  is pressed again.

Receiving an intercom call

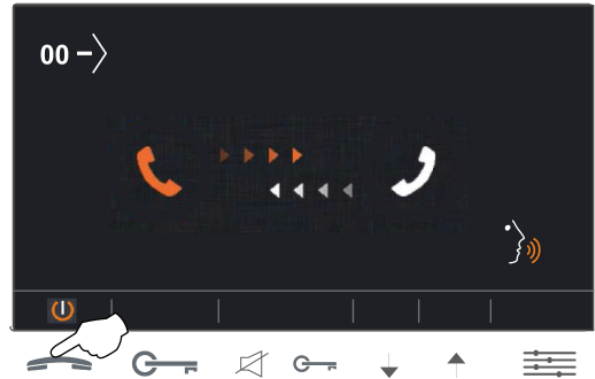

In communication



If during the intercom process a call is received from the door panel of another apartment, the intercom process will be cancelled; the monitor in the apartment will emit a melody to indicate that the call is being made and the image will appear on the master monitor. To establish communication with the door panel, press button  on the monitor. If there are slave monitors in the apartment, press button  on any of them.

The ringtones vary depending on where the call is being made from, enabling the user to identify its origin (door panel, intercom or apartment door).

4. Exiting the menu:

To exit the menu, press button .

Main menu screen

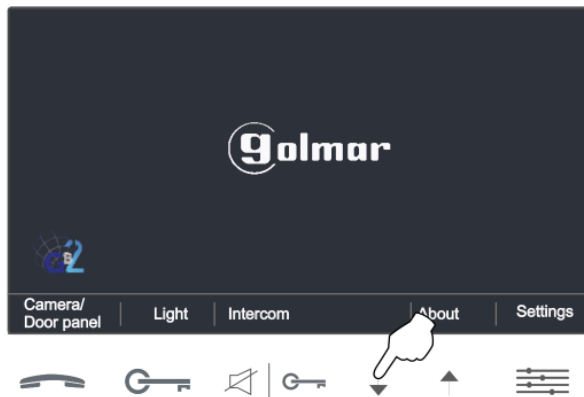

Monitor in standby

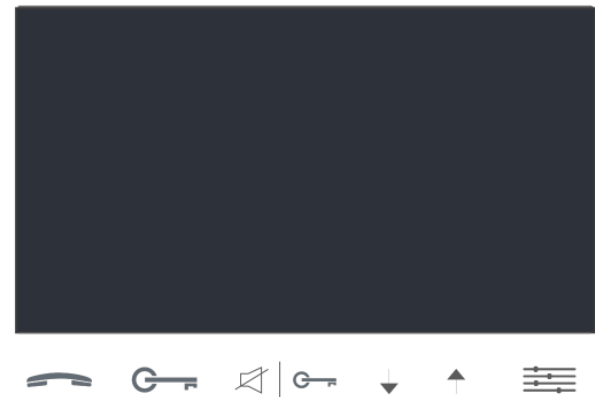

USER MENU

Continued from previous page.

5. About (information and installer setup):

Press button  . The following selection and information screen will be displayed.

Main menu screen

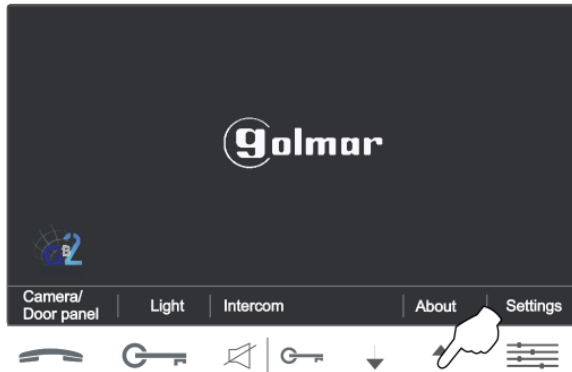

Selection and information screen

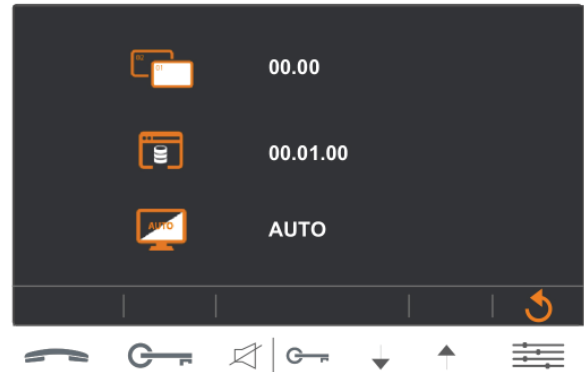



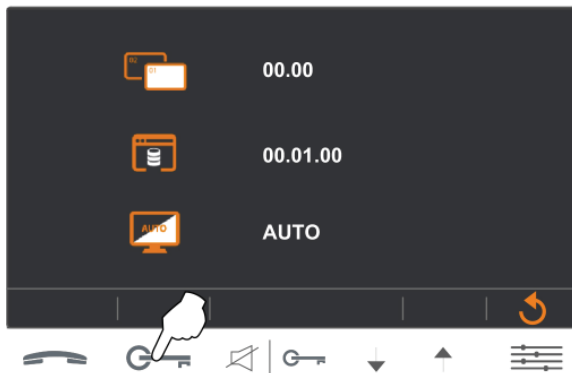

To access the installer setup, on the monitor's selection and information screen, press button  for 3 seconds. The following setup screen will be displayed.

Selection and information screen



Installer setup screen



Use buttons  and  to enter the first function code number and then press button  to enter the next function code number; repeat the previous steps until the complete function code number is entered. Confirm the function code entered by pressing button . To return to the previous screen, press option . (See installer function codes on page 19).

Installer setup screen

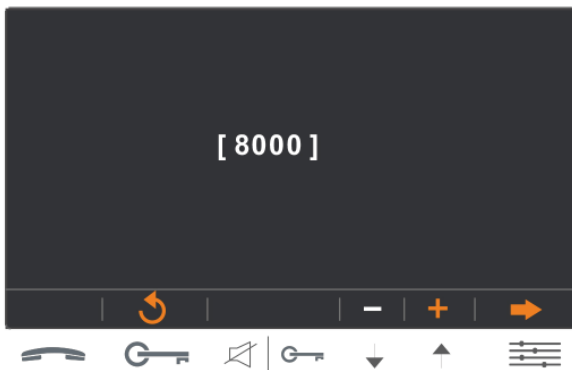

Selection and information screen

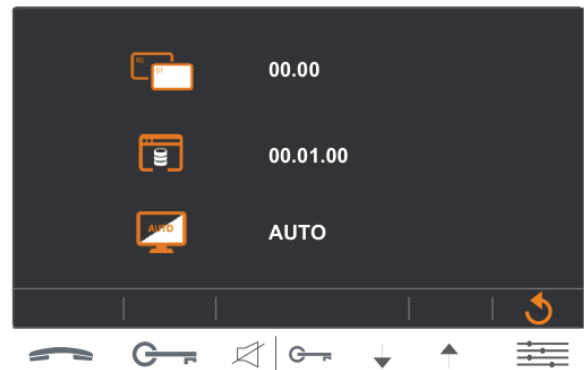

Function codes (installer):

- * [8000]: Master monitor (default setting).
- [8016]: Menu not activated if BUS is busy (default setting).
- (2)[9015]: Intercom calls enabled.
- * Each apartment must only have one master unit: Any other units in the apartment must be configured as slaves.
- (1) It is recommended to activate function code [8017]: If there is more than one monitor in the apartment and an intercom call needs to be made.
- (1)(2) It is recommended to activate function codes [9015] and [8017]: To make an intercom call between apartments.
- * [8001] to [8003]: Slave monitor 1 to 3.
- (1) [8017]: Menu activated if BUS is busy.
- [9016]: Intercom disabled (default setting).

USER MENU

Continued from previous page.

Press button  to go to the main menu screen.

Selection and information screen

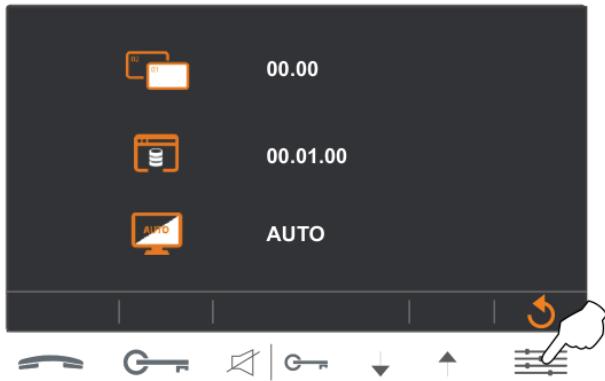

Main menu screen



6. Settings (ringtone, ringtone volume, default settings and language selection):

To access the monitor settings, press button . The settings screen will be displayed.

Main menu screen



Settings screen

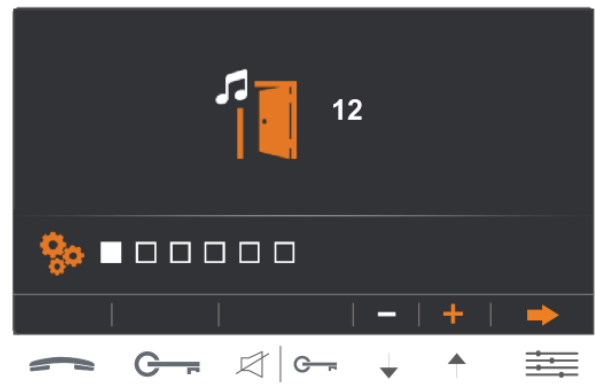

6.1 To change the door panel ringtone, use buttons  and . Then press option  to change the intercom ringtone.

Ringtone settings



Intercom ringtone settings

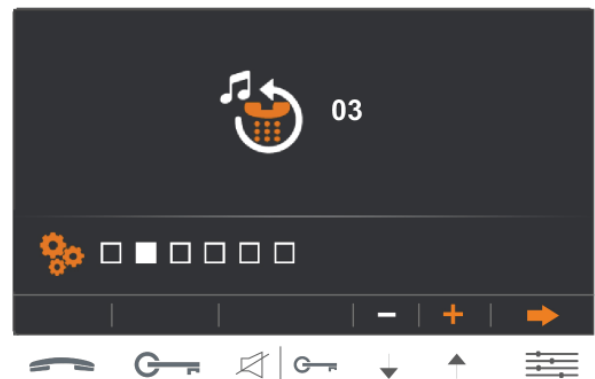

USER MENU

Continued from previous page.

6.2 To change the intercom ringtone, use buttons ↓ and ↑. Then press option  to change the apartment door ringtone.

Intercom ringtone settings

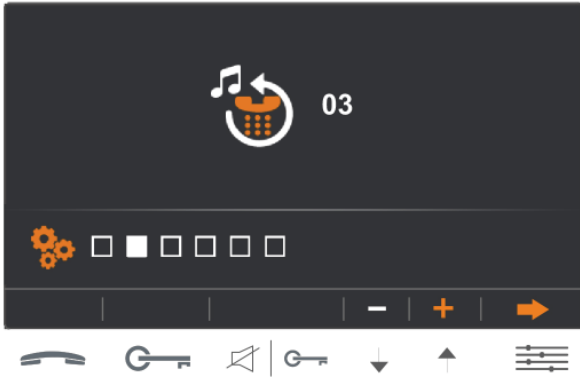

Apartment door ringtone settings

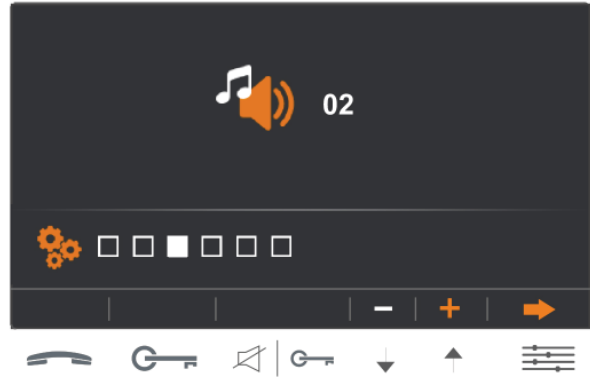

6.3 To change the apartment door ringtone, use buttons ↓ and ↑. Then press option  to change the ringtone volume.

Apartment door ringtone settings

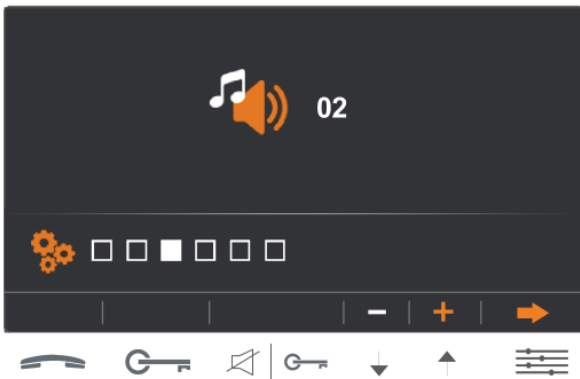

Ringtone volume settings



6.4 To change the ringtone volume, use buttons ↓ and ↑. Then press option  to access the default settings function.

Ringtone volume settings





Default settings



USER MENU

Continued from previous page.

6.5 Default settings. To reset the default settings (ringtone, ringtone volume, brightness, colour, contrast and communication volume), press button . A long tone will confirm that the function has been set. Then press option  to select the language.

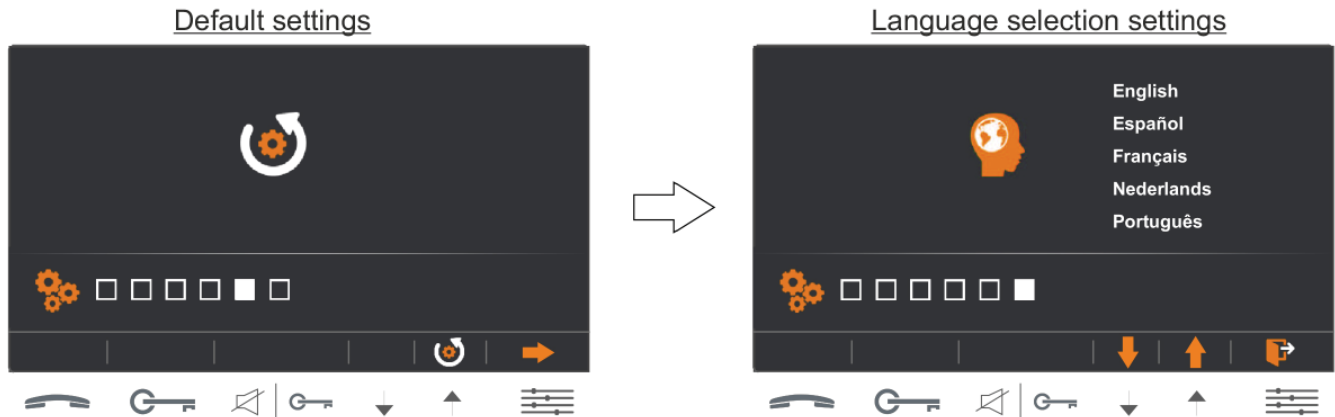

6.6 Language selection. To change the language, use buttons  and . Then press button . A long tone will confirm that the setting has been changed and the monitor will exit main menu mode.



CLEANING THE MONITOR

- Do not use solvents, detergents or cleaning products that contain acids, vinegar or abrasive components.
- Use a soft damp cloth (not wet) that sheds no fibres.
- Always wipe the monitor in the same direction, from top to bottom.
- After cleaning the monitor, remove any moisture with a soft dry cloth that sheds no fibres.

