



A3x, A4x Bullet Camera

Hardware Manual

A31, A41, A42, A43

Ver. 2017/03/01



Table of Contents

Precautions 3

Safety Instructions	5
---------------------------	---

Introduction 6

List of Models.....	6
Package Contents.....	7
Physical Description	8
Mounting Options	10

Installation Procedures 11

Step 1: Prepare for Installation.....	11
Step 2: Mount the Camera	12
Step 3: Waterproof and Connect the Cable(s).....	13
Using Waterproof Tape.....	13
Step 4: Connect to Network.....	14
Step 6: Access the Camera Live View.....	14

Other Connections 15

Connecting a Power Adapter (Optional).....	15
How to Connect Audio Input / Output Devices (Optional).....	16

Other Adjustments and Accessories 17

How to Reset the Camera	17
-------------------------------	----

Accessing the Camera 18

Configure the IP Addresses.....	18
Access the Camera.....	22

Precautions

Read these instructions

You should read all the safety and operating instructions before using this product.

Heed all warnings

You must adhere to all the warnings on the product and in the instruction manual. Failure to follow the safety instruction given may directly endanger people, cause damage to the system or to other equipment.

Servicing

Do not attempt to service this video device yourself as opening or removing covers may expose you to dangerous voltage or other hazards. Refer all servicing to qualified service personnel.

Trademarks

All names used in this manual are probably registered trademarks of respective companies.

Liability

Every reasonable care has been taken during the writing of this manual. Please inform your local office if you find any inaccuracies or omissions. We cannot be held responsible for any typographical or technical errors and reserve the right to make changes to the product and manuals without prior notice.

Federal Communications Commission Statement

This device complies with Part 15 of the FCC Rules. Operation is subject to the following two conditions:

1. This device may not cause harmful interference.
2. This device must accept any interference received, including interference that may cause undesired operation.

Note: This equipment has been tested and found to comply with the limits for a Class A digital device, pursuant to Part 15 of the FCC Rules. These limits are designed to provide reasonable protection against harmful interference when the equipment is operated in a commercial environment. This equipment generates, uses, and can radiate radio frequency energy, and if it is not installed and used in accordance with the instruction manual, it may cause harmful interference to radio communications. Operation of this equipment in a residential area is likely to cause harmful interference, in which case the user will be required to correct the interference at their own expense.

European Community Compliance Statement



This product has been tested and found to comply with the limits for Class A Information Technology Equipment according to European Standard EN 55022 and EN 55024. In a domestic environment, this product may cause radio interference in which cause the user may be required to take adequate measures.

Safety Instructions

Cleaning

Disconnect this video product from the power supply before cleaning.

Attachments

Do not use attachments not recommended by the video product manufacturer as they may cause hazards.

Water and Moisture

Do not use this video product near water, for example, near a bathtub, washbowl, kitchen sink, or laundry tub, in a wet basement, or near a swimming pool and the like.

Don't use accessories not recommended by the manufacturer

Only install this device in a dry place protected from weather

Servicing

Do not attempt to service this video product yourself as opening or removing covers may expose you to dangerous voltage or other hazards. Refer all servicing to qualified service personnel.

Damage Requiring service

Disconnect this video product from the power supply immediately and refer servicing to qualified service personnel under the following conditions.

- 1) When the power-supply cord or plug is damaged
- 2) If liquid has been spilled, or objects have fallen into the video product.
- 3) If the video product has been directly exposed to rain or water.
- 4) If the video product does not operate normally by following the operating Instructions in this manual. Adjust only those controls that are covered by the instruction manual, as an improper adjustment of other controls may result in damage, and will often require extensive work by a qualified technician to restore the video product to its normal operation.





Safety Check

Upon completion of any service or repairs to this video product, ask the service technician to perform safety checks to determine if the video product is in proper operating condition.







Introduction

List of Models

This hardware manual contains the following models:

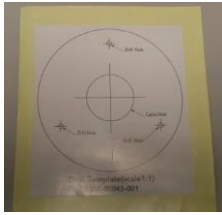
A31		3MP Bullet with D/N, Adaptive IR, Extreme WDR, SLLS, Fixed lens
A41		3MP Zoom Bullet with D/N, Adaptive IR, Extreme WDR, SLLS, 4.3x Zoom lens
A42		5MP Zoom Bullet with D/N, Adaptive IR, Extreme WDR, SLLS, 2.8x Zoom lens
A43		2MP Zoom Bullet with D/N, Adaptive IR, Extreme WDR, ELLS, 4.3x Zoom lens

Package Contents

Camera	Mounting Screw Kit	Camera Base Wrench
		
Drill Template	DI/DO Terminal Block (A4x only)	Warranty Card
		
Quick Installation Guide		
		

Physical Description

A3x

Side



Back



Item		Description
1	Ethernet Port	Connects to a network using a standard Ethernet cable.
2	Audio Output	This jack connects to an audio output device, such as a speaker. See How to Connect Audio Input / Output Devices (Optional) on page 16.

A4x

Side



Back



Item		Description
1	Audio Output	This jack connects to an audio output device, such as a speaker. See How to Connect Audio Input / Output Devices (Optional) on page 16.
2	DC 12V Power Input	Connects the camera to an external power adapter (not included). See Connecting a Power Adapter (Optional) for A4x only on page 15 for more information.
3	Reset Button	Restores the factory default settings of the camera, including the administrator’s password. See How to Reset the Camera on page 17.
4	BNC Video Output	Connects the camera directly to a monitor with BNC input.
5	Audio Input	This jack connects to a microphone. See How to Connect Audio Input / Output Devices (Optional) on page 16
6	Ethernet Port	Connects to a network using a standard Ethernet cable.
7	Digital Input / Output	Connects to digital input or output devices, such as an alarm trigger, panic button, etc. Digital Input (DI) and Digital Output (DO) devices are used in applications like motion detection, event triggering, alarm notifications, etc.

Mounting Options

There are several mounting options that you can use to install the camera. Select the most suitable solution for your installation environment.

Mount Types	Accessories
Wall	Suitable when mounting the camera directly on walls using the integrated bracket. See <i>Installation Procedures</i> on page 11.
Ceiling	Suitable when mounting the camera directly on walls using the integrated bracket. See <i>Installation Procedures</i> on page 11.
Vertical Pole	Suitable when mounting the camera on vertical poles.

NOTE:

- For more information about the mounting solutions and accessories, please check the *Mounting Accessory Selector* in our website (<http://www.acti.com/mountingselector>).
- The above mounting accessories are not included in the package. Contact your sales agents to purchase.

Installation Procedures

This section describes the procedures in installing the camera on a flat surface such as a hard or dropped ceiling and straight or tilted walls. Before installation, make sure the wall or ceiling can bear more than the weight of the camera.

Step 1: Prepare for Installation

1. Depending on the wall material, purchase applicable screws and screws plugs (as needed) that can hold the camera and bracket weight on the wall.
2. Attach the supplied drill template sticker on the wall.
3. Determine how the cable will be routed: **pass through the wall** or **along the wall**.
 - **If the cable will pass through the wall**, drill the cable hole and the three (3) screw holes on the wall.

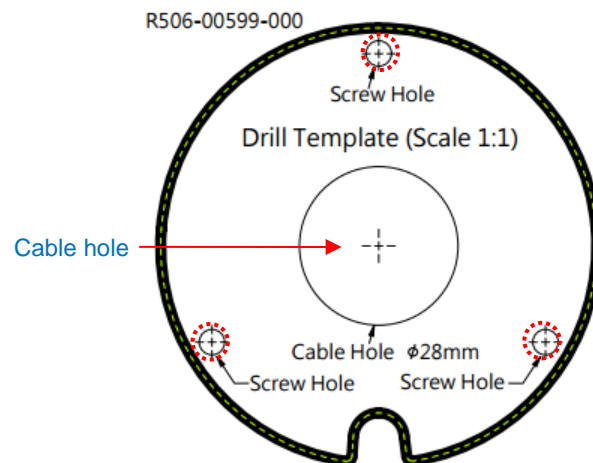

- **If the cable will be routed along the wall**, just drill the three (3) screw holes on the wall.
4. Detach the drill template sticker from the wall and insert the plastic plugs into the screw holes.

Step 2: Mount the Camera

1. Mark the location of the screw holes based on the drill template included in the package.
NOTE: Depending on the surface where you will install the camera, it may be necessary to drill three (3) holes and use the supplied screw tox.
2. Attach the camera to the surface using the three (3) supplied screws.
3. Adjust the camera installation angle and orientation, and then tighten the two (2) screws to fix its position.



Step 3: Waterproof and Connect the Cable(s)

The camera and the pre-installed network cable, “pigtail”, are resistant to salt, water, weak acid, alcohol, oil, grease and other common solvents. However, users must ensure that the cable connection and the network side cable itself are also protected from different environmental factors.

Using Waterproof Tape

Regardless of the shape of the camera cable connector, the simplest way to waterproof to connection is by using the waterproof tape.

Connect an Ethernet cable from the network side to the Ethernet port of the camera and wrap the connection with waterproof tape to complete the installation.

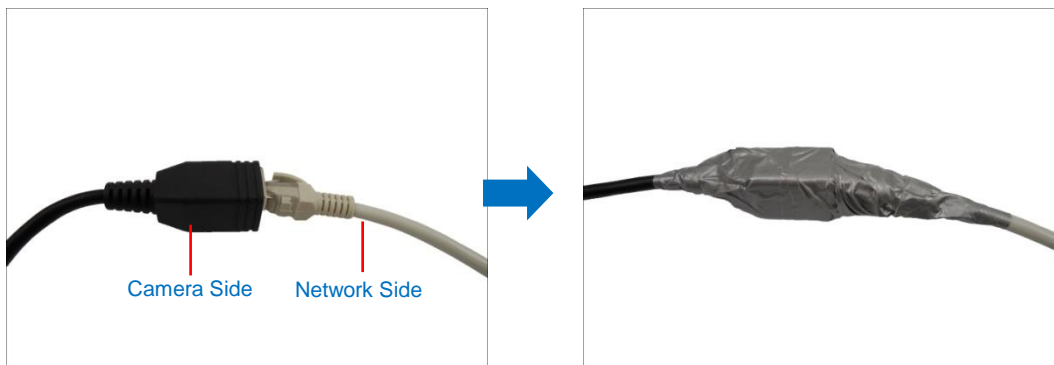

NOTES on using Ethernet cables: For outdoor installations, it is recommended to use *exterior-grade* Ethernet cables (CAT5/CAT5e/CAT6); ordinary Ethernet cables are only designed for indoor use and may deteriorate quickly when exposed to outdoor elements. Exterior-grade Ethernet cables are waterproof and do not require a conduit.

Step 4: Connect to Network

Connect the other end of the network cable to a switch or injector. Then, connect the switch or injector to a network, PC, and a power source. See Power-over-Ethernet (PoE) connection example below.

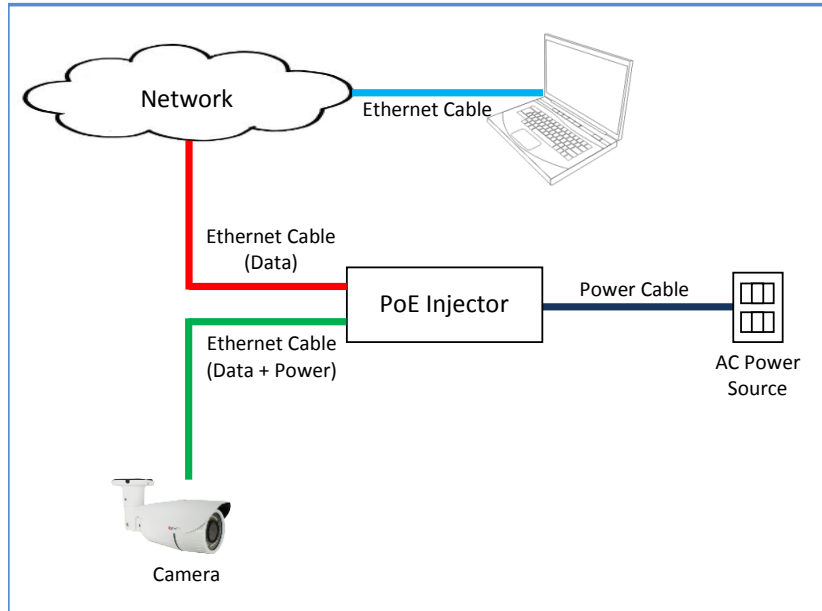

Step 6: Access the Camera Live View

See [Accessing the Camera](#) on page 18 for more information on how to access the Live View of the camera.

Other Connections

This section describes the procedures in preparing the external devices that you can connect to the camera. The camera supports DC12V power input, Digital Input and Output (DI/DO) and Audio Input and Output devices using the bundled terminal blocks. The use of these devices, however, is optional.

NOTE: After connecting external devices, use a waterproof tape to protect the cable connection or house the cable inside a junction box (purchased separately).

Connecting a Power Adapter (Optional for A4x only)

The camera can be powered by a Power over Ethernet (PoE) switch that is IEEE802.3af compliant. In case of using a non-PoE switch or your PoE switch has a limited power supply, you can purchase a power adapter and directly connect the camera to a power outlet.

NOTE: The power adapter is not bundled in the package.

The DC12V connector is already attached to the camera.



How to Connect Audio Input / Output Devices (Optional)

A3x

For A3x models, connect the audio output device, such as a speaker, to the **Audio Output** jack of the camera. If the camera will be installed outdoors, make sure to wrap the cable with waterproof tape or use a junction box to protect the cable from water leak.

A4x

If using an audio input device, such as a microphone with a built-in amplifier, connect the device to the **Mic Input** jack (RED) of the camera. If using an audio output device, such as a speaker, connect the device to the **Audio Output** jack (GREEN) jack of the camera.

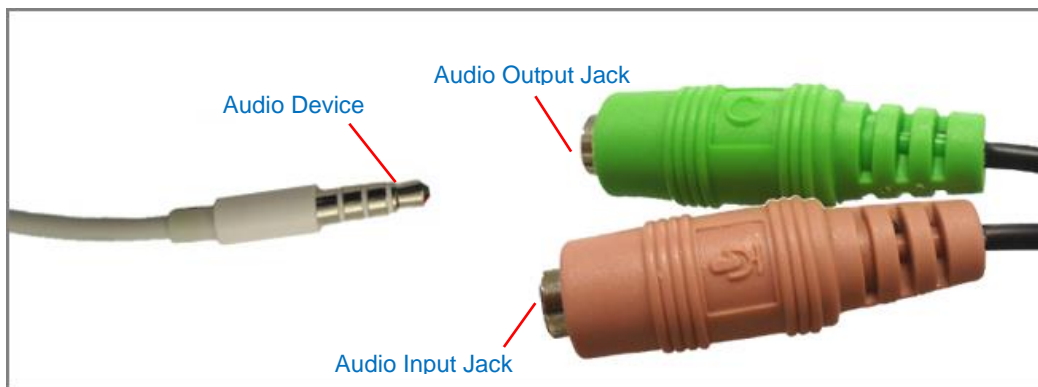

NOTE: Make sure that the connected audio input device has a built-in amplifier. Connecting an ordinary microphone will dwarf sounds and will result in inaudible recording.

Other Adjustments and Accessories

How to Reset the Camera (A4x only)

The camera has a **Reset** button that can be used to restore the camera to its factory default settings when the need arises.

The **Reset** button is used for the following purposes:

- The administrator's password is forgotten and therefore the camera cannot be accessed
- In case of IP address, mask, or allow/deny filter related issues, resulting with the inability to modify these settings
- In case of connectivity issues or abnormal video quality

Perform the following to reset the camera to its default settings:

1. Disconnect the camera from its power source (either by PoE or DC power).
2. Press and hold the **Reset Button** and re-connect the power source to the camera.
3. Continue pressing the **Reset Button** until the green Ethernet LED lights up.

Accessing the Camera

Configure the IP Addresses

In order to be able to communicate with the camera from your PC, both the camera and the PC have to be within the same network segment. In most cases, it means that they both should have very similar IP addresses, where only the last number of the IP address is different from each other. There are 2 different approaches to IP Address management in Local Area Networks – by DHCP Server or Manually.

Using DHCP server to assign IP addresses:

If you have connected the computer and the camera into the network that has a DHCP server running, then you do not need to configure the IP addresses at all – both the camera and the PC would request a unique IP address from DHCP server automatically. In such case, the camera will immediately be ready for the access from the PC. The user, however, might not know the IP address of the camera yet. It is necessary to know the IP address of the camera in order to be able to access it by using a Web browser.

The quickest way to discover the cameras in the network is to use the simplest network search, built in the Windows system – just by pressing the “Network” icon, all the cameras of the local area network will be discovered by Windows thanks to the UPnP function support of our cameras.

In the example below, we successfully found the camera model that had just connected to the network.

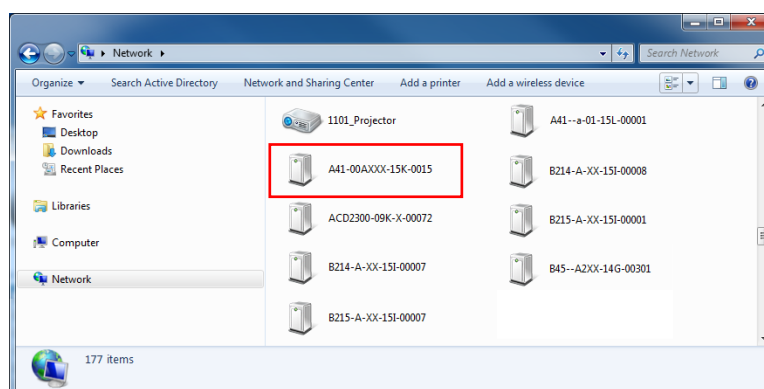

Double-click the mouse button on the camera model name, the default browser of the PC is automatically launched and the IP address of the target camera is already filled in the address bar of the browser.

If you work with our cameras regularly, then **there is even a better way to discover the cameras in the network** – by using **IP Utility**. The IP Utility is a light software tool that can not only discover the cameras, but also list lots of valuable information, such as IP and MAC addresses, serial numbers, firmware versions, etc, and allows quick configuration of multiple devices at the same time.

The latest IP Utility can be downloaded for free from http://www.acti.com/IP_Utility

When you launch IP Utility, the list of connected cameras in the network will be shown. See sample illustration below:

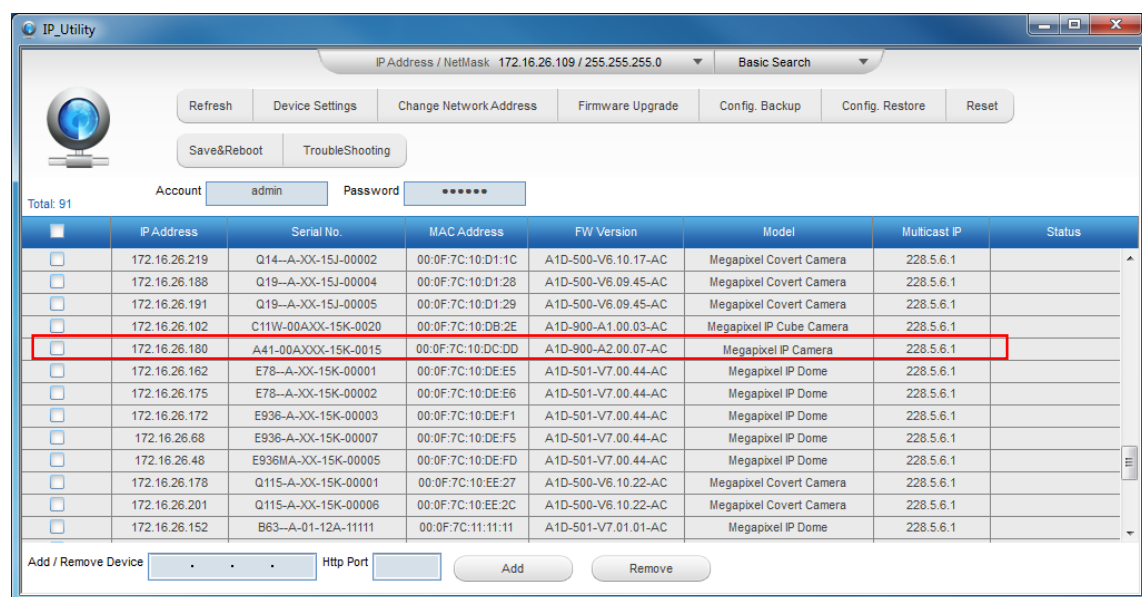

You can quickly notice the camera model in the list. Click on the IP address to automatically launch the default browser of the PC with the IP address of the target camera filled in the address bar of the browser already.

Use the default IP address of a camera:

If there is no DHCP server in the given network, the user may have to assign the IP addresses to both PC and camera manually to make sure they are in the same network segment.

When the camera is plugged into network and it does not detect any DHCP services, it will automatically assign itself a default IP:

192.168.0.100

Whereas the default port number would be **80**. In order to access that camera, the IP address of the PC has to be configured to match the network segment of the camera.

Manually adjust the IP address of the PC:

In the following example, based on Windows 7, we will configure the IP address to **192.168.0.99** and set Subnet Mask to **255.255.255.0** by using the steps below:

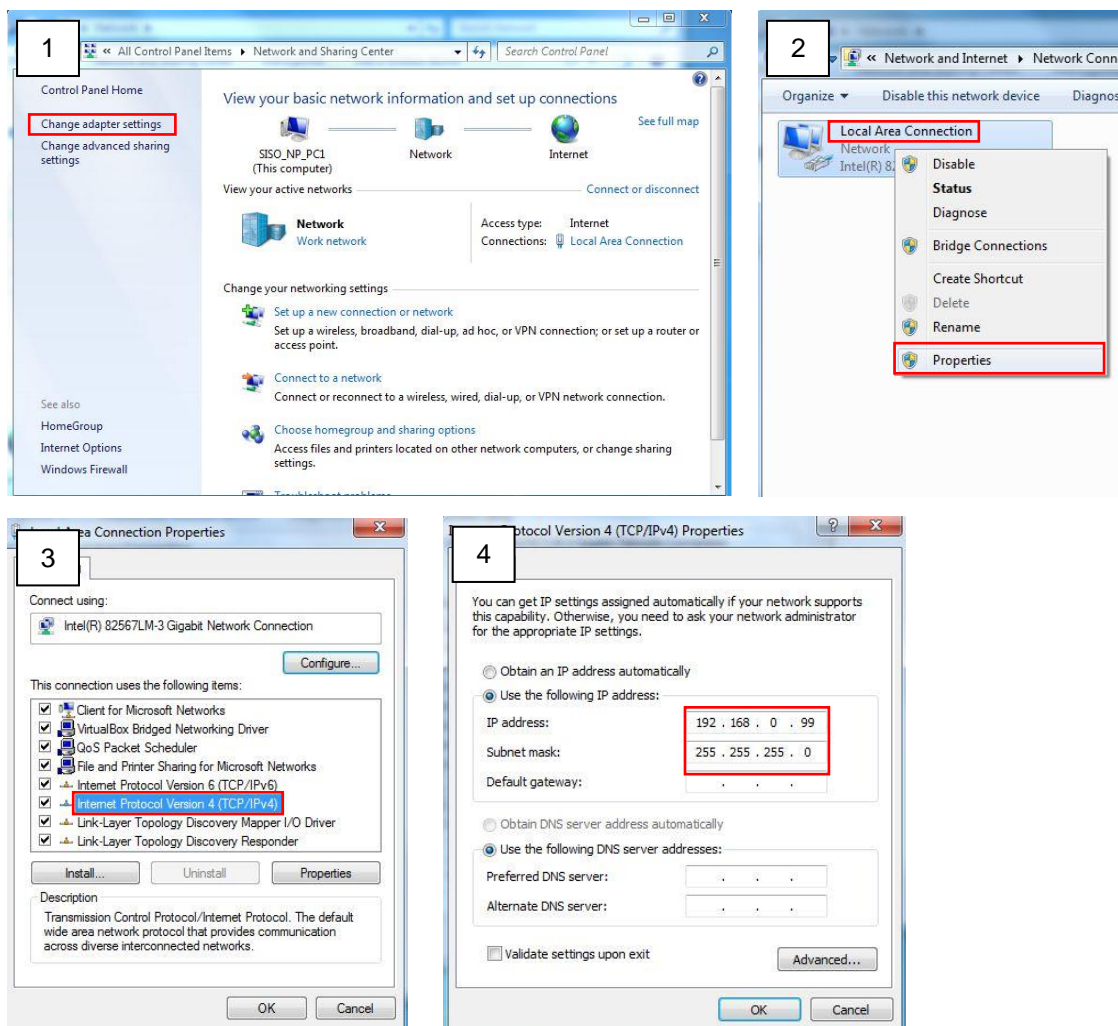

Manually adjust the IP addresses of multiple cameras:

If there are more than 1 camera to be used in the same local area network and there is no DHCP server to assign unique IP addresses to each of them, all of the cameras would then have the initial IP address of **192.168.0.100**, which is not a proper situation for network devices – all the IP addresses have to be different from each other. The easiest way to assign cameras the IP addresses is by using **IP Utility**:

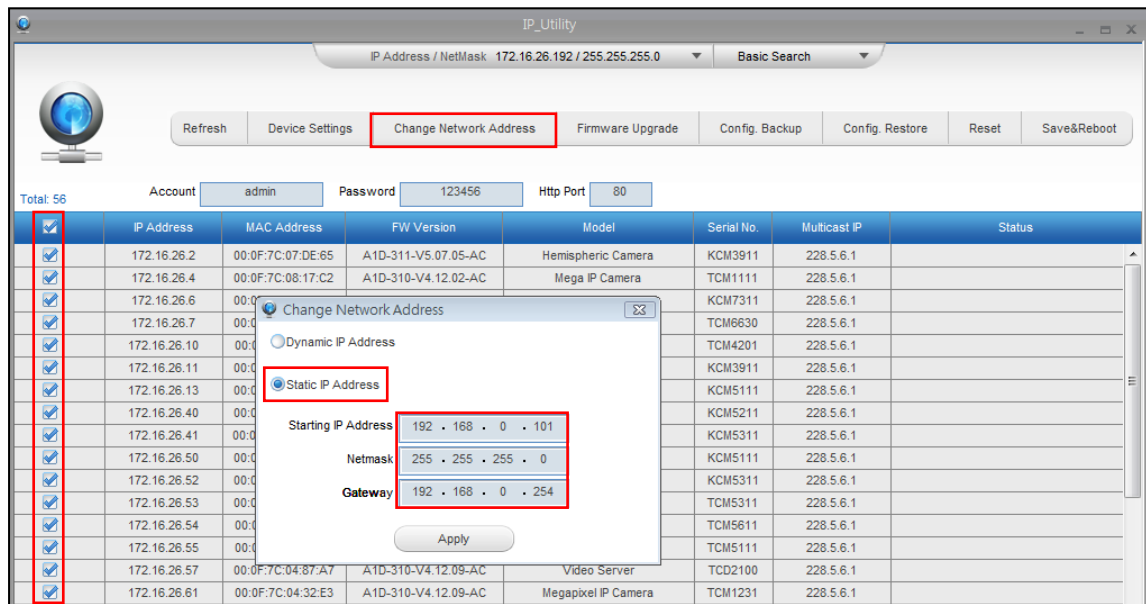

With the procedure shown above, all the cameras will have unique IP addresses, starting from 192.168.0.101. In case there are 20 cameras selected, the last one of the cameras would have the IP 192.168.0.120.

Later, by pressing the “Refresh” button of the IP Utility, you will be able to see the list of cameras with their new IP addresses.

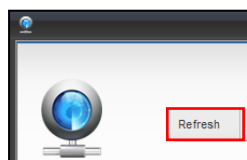

Please note that it is also possible to change the IP addresses manually by using the Web browser. In such case, please plug in only one camera at a time, and change its IP address by using the Web browser before plugging in the next one. This way, the Web browser will not be confused about two devices having the same IP address at the same time.

Access the Camera

Now that the camera and the PC are both having their unique IP addresses and are under the same network segment, it is possible to use the Web browser of the PC to access the camera.

Full functionality is provided only for **Microsoft Internet Explorer**.

The browser functionality comparison:

Functionality	Internet Explorer
Live Video	Yes
Live Video Area Resizable	Yes
PTZ Control	Yes
Capture the snapshot	Yes
Video overlay based configuration (Motion Detection regions, Privacy Mask regions)	Yes
All the other configurations	Yes

When using Internet Explorer browser, the ActiveX control for video stream management will be downloaded from the camera directly – the user just has to accept the use of such control when prompted so. No other third party utilities are required to be installed in such case.

The examples in this manual are based on Internet Explorer browser in order to cover all functions of the camera.

Assuming that the camera's IP address is **192.168.0.100**, you can access it by opening the Web browser and typing the following address into Web browser's address bar:

<http://192.168.0.100>

Upon successful connection to the camera, the user interface called **Web Configurator** would appear together with the login page. The HTTP port number was not added behind the IP address since the default HTTP port of the camera is 80, which can be omitted from the address for convenience.

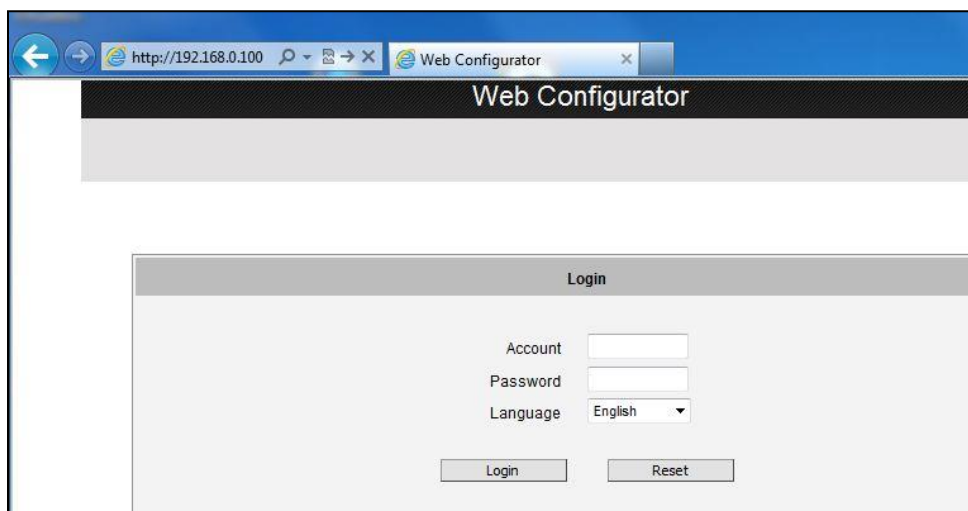

Before logging in, you need to know the factory default Account and Password of the camera.

Account: **Admin**

Password: **123456**

For further operations, please refer to the **Firmware User Manual**.



Copyright © 2015, ACTi Corporation All Rights Reserved

7F, No. 1, Alley 20, Lane 407, Sec. 2, Ti-Ding Blvd., Neihu District, Taipei, Taiwan 114, R.O.C.

TEL : +886-2-2656-2588 FAX : +886-2-2656-2599

Email: sales@acti.com