

Flexible Intensifier® Technology Bullet IP Camera

QUICK INSTALLATION GUIDE



O3FDP9

Please read this guide carefully before installation and operation of the product.

Notice

Thank you for purchasing this product. This guide is designed to be a reference tool for the product. Please read it carefully before operating the product and retain it for future reference. Should you require any technical assistance, please contact Speco Technologies Technical Support.



The lightning flash with an arrowhead symbol, within an equilateral triangle is intended to alert the user to the presence of non-insulated dangerous voltage within the product's enclosure that may be of sufficient magnitude to constitute a risk of electric shock to persons.



The exclamation point within an equilateral triangle is intended to alert the user to the presence of important operating and maintenance (servicing) instructions in the literature accompanying the appliance.

INFORMATION

This equipment has been tested and found to comply with limits for a Class A digital device, pursuant to part 15 of the FCC Rules. These limits are designed to provide reasonable protection against harmful interference when the equipment is operated in a commercial environment. This equipment generates, uses, and can radiate radio frequency energy and, if not installed and used in accordance with the instruction manual, may cause harmful interference to radio communications. Operation of this equipment in a residential area is likely to cause harmful interference in which case the user will be required to correct the interference at its own expense.

WARNING

Changes or modifications not expressly approved by the manufacturer could void the user's authority to operate the equipment.

CAUTION – To prevent electric shock and risk of the fire hazards

- Do NOT use power source other than that specified.
- Do NOT expose this appliance to rain or moisture.

This installation should be made by a qualified service person and should conform to all local codes.

PRECAUTIONS

- Please read the manual carefully before the installation in order to set up the camera correctly and to obtain the best picture quality.
- Installation and services should only be carried out by an authorized personnel according to local safety regulations.
- If any liquid or solid matter gets into the housing, immediately disconnect the camera from power supply and have it checked by your authorized dealer before reusing.
- Avoid installing the camera in extremely hot or cold places.
- If you are not a certified person, never try to dismantle the camera.
To avoid electric shock, never remove the screws or covers. There are no parts inside that need maintenance by the user. All maintenance should be carried out by qualified personnel.
- Avoid installing the camera in a place of high humidity.
- Avoid installing the camera at a place exposed to gas or oil.
- Don't point the camera directly at sunlight.
- Please pay special attention to keep the unit from dropping or external shock during the process of transportation or handling.
- Never try to touch the camera with wet hands. It may cause an electric shock.
- Do not expose the camera to radioactivity. It can cause a serious damage on the image sensor.

LIMITATION OF LIABILITY

This publication is provided "AS IS" without warranty of any kind, either express or implied, including but not limited to, the implied warranties of merchantability, fitness for any particular purpose, or non-infringement of the third party's right.

This publication could include technical inaccuracies or typographical errors. Changes are added to the information herein, at any time, for the improvements of this publication and / or the corresponding product(s).

DISCLAIMER OF WARRANTY

In no event shall seller be liable to any party or any person, except for replacement or reasonable maintenance of the product, for the cases, including but not limited to below :

- (1) Any damage and loss, including without limitation, direct or indirect, special, consequential or exemplary, arising out of or relating to the product.
- (2) Personal injury or any damage caused by inappropriate use or negligent operation of the user.
- (3) Unauthorized disassembly, repair or modification of the product by the user.
- (4) Inconvenience or any loss when images are not displayed, due to any reason or cause including any failure or problem of the product.
- (5) Any problem, consequential inconvenience, or loss or damage, when combined with third party devices.
- (6) Any claim or action for damages, brought by any person or organization, due to a violation of privacy when the surveillance footage, for some reason, becomes public or is used for the purpose other than surveillance.

1. PRODUCT OVERVIEW

Key Features

- 3.0 Mega pixel 1/2.8" SONY progressive scan CMOS image sensor for excellent image quality
- 2.8mm wide angle lens
- 3-axis design
- Support for corridor view (in H.264)
- Integrated motion detection with pre- and post-alarm image / video buffering
- Supports CBR (Constant Bit Rate) and VBR (Variable Bit Rate) modes
- Supports Tampering-Alarm
- Controllable frame rate
- Privacy Masking up to 8 areas
- Built-in standard PoE (802.3af)
- HTTPS support
- Integrated E-Mail, FTP, DDNS and DHCP client

Specifications







CLASSIFICATION		SPEC
General	CPU	ARM1176JZF-STM (400 MHz, Instruction cache : 32kbyte, data cache : 16kbyte, MMU)
	Flash	2Gbit Flash Memory
	SDRAM	2Gbit DDR3 Memory
Image Pickup	Image Sensor	3.1 Megapixel 1/2.8" SONY Progressive Scan CMOS Image Sensor
	Total Pixels	2065(H) x 1565(V) 3.23 Megapixel
	Effective Pixels	2065(H) x 1553(V) 3.21 Megapixel
	S/N Ratio	More than 50dB
	Min. Illumination	0Lux (IR On)
	IR Distance	65'
	Day & Night	IR cut filter
	Lens	2.8mm fixed lens
Video	Video Compression	H.264 High Profile @ Level 5.0 (2048 x 1536), @ Level 4.1 (Other resolutions), Motion JPEG
	Resolutions	Up to 2048 x 1536
	Frame Rate	H.264 Up to 30fps with 2048 x 1536
		MJPEG Up to 30fps with VGA Resolution
	Video Streaming	Support Multi Stream with H.264, MJPEG
		Adjustable Frame Rate
		VBR / CBR in H.264
	Image Setting	Brightness, Contrast, Sharpness
		Day & Night
		Auto White Balance
		Auto Exposure
		Privacy Mask
		DSS, Corridor-view (in H.264), Mirror / V-Flip, etc.
Backlight	WDR	
Shutter Speed	1/4 ~ 1/2000	
Noise Reduction	2D / 3DNR	
Network	Dynamic IP	SPECO DDNS (Free of Charge)
	Security	Password Protection
		User Access Log
		HTTPS Encryption

	Supported Protocol	HTTP, HTTPS, DNS, RTSP, RTP, TCP, UDP, ICMP, DHCP
System Integration	Intelligent Video	Motion detection 12 x 12 blocks
	Alarm Trigger	Motion Detection, Tampering Alarm
	Firmware Upgrade	Remote Upgrade via Network
Physical	Etc	1 x Factory Reset Button
	Memory Slot	Save to Micro SD card with event mode and continuous mode
	Power Source	DC 12V / 1.5A, POE (Power Over Ethernet) : 802.3af
	Power Consumption	Max. 3.0W, Max. 5.0W with IR On
	Net Weight	10 oz
	Dimension(in)	5.12(∅) x 3.03(H)
Environment	Operating Temperature	-14F ~ 122F
	Storage Temperature	-4F ~ 140F

※ Specifications are subject to change without prior notice for improvement.

2. NAME AND FUNCTION OF EACH PART

2.1 Package Contents

APPEARANCE	DESCRIPTION
	IP Camera x 1
	Installation Guide x 1
	Drilling Template x 1
	Tapping screw (∅4 x 30) x 3
	Plastic anchor x 3
	CD x 1

2.2 Name and Function

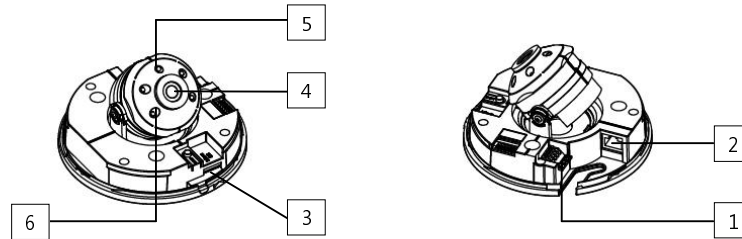

NO.	ITEM	DESCRIPTION
1	Power Connector	DC12V ※ Caution : If O3FDP9 is powered by PoE, do not plug in DC Jack with active DC power into DC power connector.
2	Network and POE Connector	POE (Power over Ethernet) and LAN cable
3	SD Card Slot	Up to SDXC, 32GB
4	Lens	2.8mm fixed lens
5	Illumination sensor	Control IR LED by sensing light
6	IR LED	Infrared Hi-power LED

3. INSTALLATION

3.1 How to Mount to Ceiling / Wall

- Ceiling

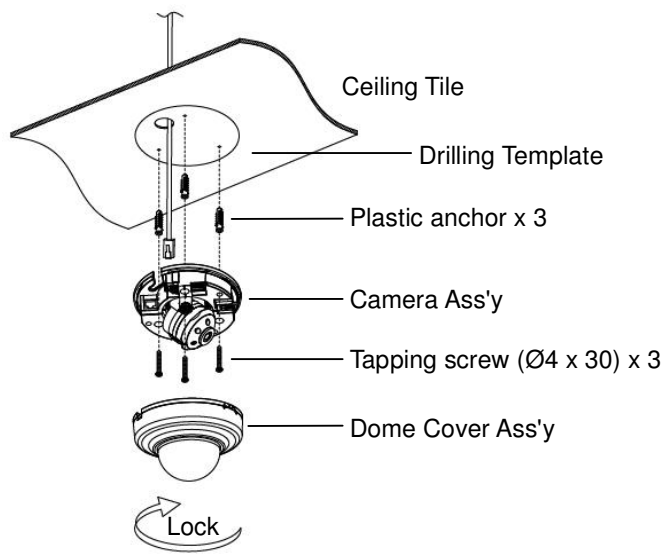

• Wall

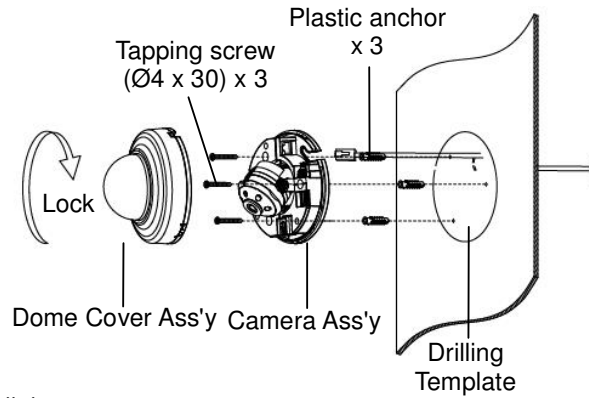

- ① Select the place to install the camera.
- ② Place the Drilling template on the ceiling and drill the holes.
- ③ Fix the plastic anchors in the holes.
- ④ Fix the camera by tightening tapping screws.
- ⑤ Adjust the camera angle and attached the Dome Cover.

※ **Note**

Do not touch the lens while making adjustment.

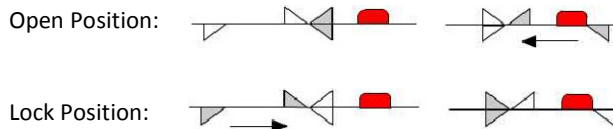
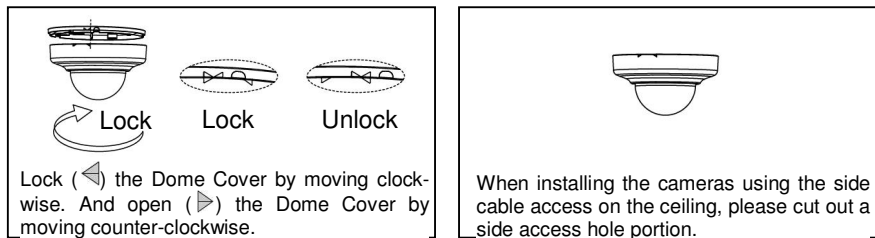

Side Cable Access:

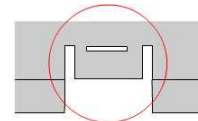

3.2 3-Axis Adjustment

- ① Panning 360°
Slightly loosen Pan Bracket nut then adjust pan of the camera and tighten the Bracket nut.
- ② Tilt 75°
Slightly loosen Tilt bolt then adjust tilt of the camera and tighten the bolt firmly.
- ③ Rotation 360°
Slightly loosen Tilt bolt then adjust rotation of the camera and tighten the bolt firmly.

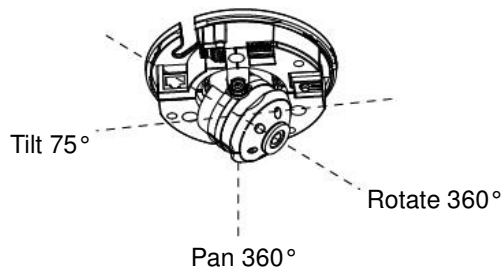

3.3 INSTALLATION EXAMPLE

3.3.1 Installation Example

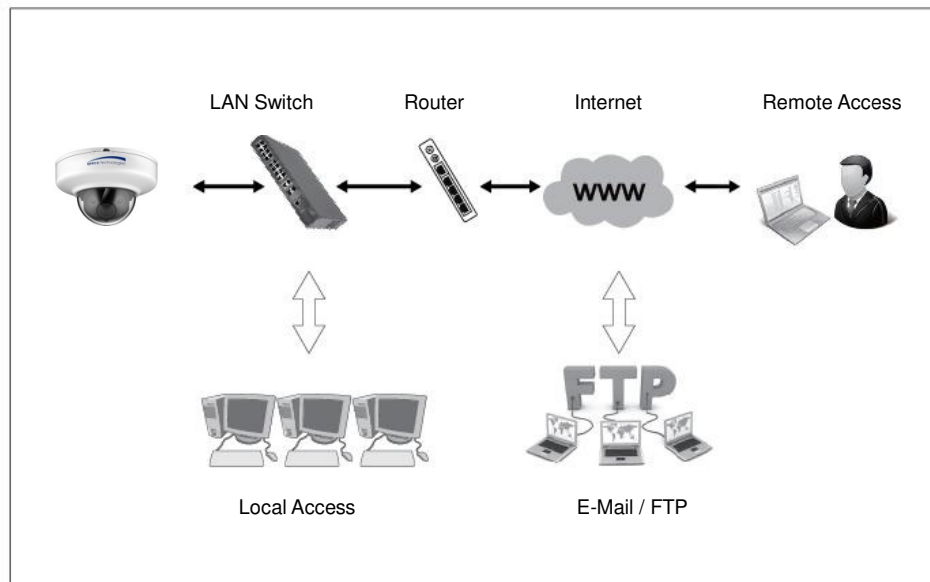

3.3.2 Connecting to the Network

Open up IP Scanner.

IP Scanner can search for the device on the local network.

Please note that only devices that are on the same subnet can be discovered.

The device is set to DHCP mode by default.

In the device list, you can view the IP address, model number, and MAC address of each device. Select the applicable device and double click to open up the web viewer.

The screenshot shows the SecureGuard IP Scanner interface. The top bar contains several icons: Refresh, Open Web Page, Login..., IP (with a dropdown arrow), Restart, Factory Default, Information, and About. Below the icons is a table with the following columns: Status, Name, IP Address, MAC Address, and Version.

Status	Name	IP Address	MAC Address	Version
Online	O2D4M	192.168.56.128	00:07:18:FF:03:73	1.0.57
Online	O2D4	192.168.56.143	5C:F2:07:1C:28:CA	1.0.53
Online	VIP2PTZ12X	192.168.56.157	00:07:D8:17:8A:68	1.3.7-X1_release
Online	VIP2D1M	192.168.56.149	5C:F2:07:20:9D:AD	2.5.0-T3_release
Online	O5MDP1	192.168.56.139	5C:F2:07:1C:3E:66	1.0.47
Online	Eddie-O2DP8	192.168.56.104	5C:F2:07:1C:1F:74	1.0.47
Online	O5MDP1	192.168.56.124	5C:F2:07:1C:23:D8	1.0.47
Online	O2DP9	192.168.56.147	5C:F2:07:1C:74:16	1.0.54
Online	OB1	192.168.56.105	5C:F2:07:1C:01:3B	
Online	OPTZ36X1	192.168.56.140	5C:F2:07:1C:03:1D	
Online	n/a	192.168.56.130	5C:F2:07:24:00:1A	2236.0.0.1412190
Online	n/a	192.168.56.14	5C:F2:07:24:03:C2	2236.0.0.1409180
Online	n/a	192.168.56.12	5C:F2:07:24:51:2E	2218.0.0.1409180
Online	O2VLB2	192.168.56.146	4C:11:BF:8A:23:64	

3.3.3 Accessing the Camera or video server's Homepage

- 1) Open the browser and input network camera address in the address bar or double click the device in IP Scanner.

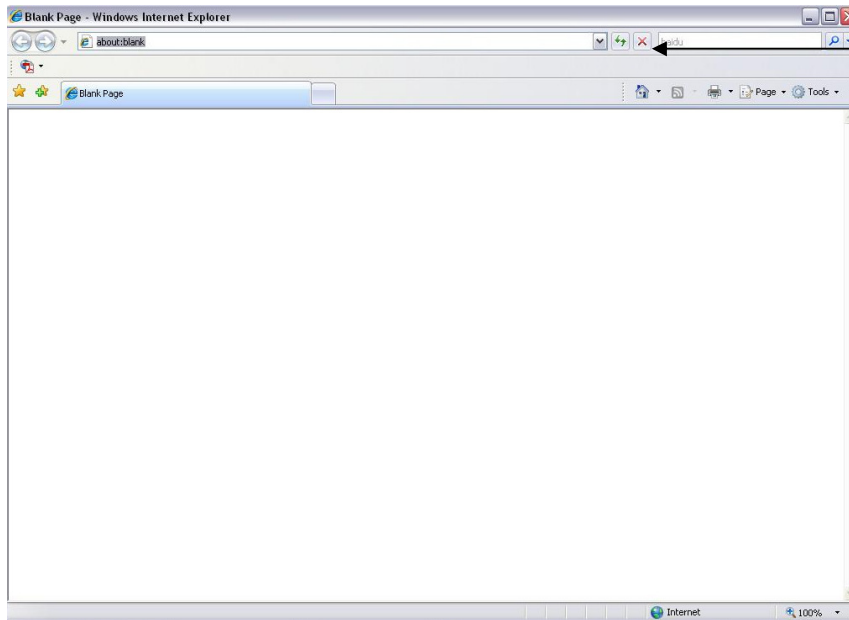

Input your IP address here

- 2) Please input your user name and password when prompted.
- 3) Default user name is **admin** and password is **1234**.
- 4) The first time you login to the camera, you will be notified that a ActiveX control is required to be installed. You need to allow the installation of ActiveX.

4. DIMENSIONS (mm)

