

Two Eyes. 100,000 Reasons.

MOBOTIX dual lens, day/night camera with two separate HiRes image sensors is successfully in use in over 100,000 installations worldwide. Brilliant color for the day and extremely light-sensitive black/white sensor for the night. The intelligent and robust professional solution from MOBOTIX with no moving parts!

HiRes
3 Megapixels
 2048 x 1536
 Software zoom

Skyline
Format free
 Each image format
 freely definable

MxPEG
30 Frames/s
 VGA (640 x 480)
 10 F/s 3Mega

Virtual PTZ
 Digital pan, tilt,
 zoom

Backlight
 Safe using CMOS
 without mechanical iris

Internal DVR
 Internal via Flash,
 external via Network

Win/Lin/Mac
Recording
 Via Netzwerk on PC
 up to 1 Terabyte

Microphone & speaker
Audio
 Bi-directional, via IP,
 variable frame rates

SIP client with video
IP Telephony
 Alarm notify,
 camera remote control

VideoMotion
 Multiple windows,
 precision pixel-based

-22 to +140°F
Weatherproof
 -30 to +60°C, IP65,
 no heating necessary

IEEE 802.3af
PoE
 Network power
 even in winter

Robust
 No moving parts,
 fiber glass housing

MxCC/MxEasy
License free
 Video Management
 Software

HiRes Video Innovations

The German company MOBOTIX AG is known as the leading pioneer in network camera technology and its decentralized concept has made high-resolution video systems cost efficient.

MOBOTIX AG • D-67722 Langmeil • Tel: +49-6302-9816-103 • Fax: +49-6302-9816-190 • sales@mobotix.com

M12 CAMERA MANUAL PART 1

1	INTRODUCTION	6
1.1	MOBOTIX Cost Benefits	8
1.2	MOBOTIX Technical Advantages	9
1.3	The Concept Behind the MOBOTIX M12	10
1.4	Product Advantages of the MOBOTIX M12	14
1.5	Feature List	16
1.6	MOBOTIX M12 Lens Options	18
1.7	Hard- and Software Differences of the MOBOTIX M10/M12	19
1.8	Important Notes	20
1.8.1	MOBOTIX M12—Weatherproof to IP65	20
1.8.2	Password for the Administration Menu	20
1.8.3	Password for ISDN Dial-In	21
1.8.4	Irreversibly Deactivating the Microphone	21
1.8.5	Starting the Camera Using the Factory IP Address	21
1.8.6	Resetting the Camera to Factory Defaults	21
1.8.7	Activating Event Control for Security Applications	21
1.8.8	Deactivating Text and Logo Options	22
1.8.9	Deactivating the Daily Reboot of the Camera	22
1.8.10	ISDN Compatibility Note	22
1.8.11	Using Internet Browsers	22
1.8.12	Cleaning Instructions – Cleaning the Lenses	22
1.8.13	Safety Notes for Operating MOBOTIX Cameras	23
1.8.14	Maximum Cable Lengths	23
1.8.15	Additional Information	23
2	MOUNTING THE CAMERA	24
2.1	Delivered Parts, Camera Components and Dimensions	24
2.1.1	Standard Delivery	24
2.2	Camera Housing and Connectors	25
2.2.1	External Sensors	25
2.2.2	Connectors	25
2.3	Optional Accessories	26
2.4	Wiring, Fire Prevention, Lightning and Surge Protection	28
2.4.1	Wiring	28
2.4.2	Fire Prevention	28
2.4.3	Lightning and Surge Protection	28
2.5	Providing the Connections (Network/ISDN)	29

2.6	Power Supply of the MOBOTIX M12	30
2.6.1	Using Uninterruptible Power Supplies (UPS)	31
2.7	Determining Where to Mount the Camera	32
2.8	MOBOTIX M12 Lens Options	33
2.9	The MOBOTIX SecureFlex Mount	35
2.10	Dimensions (Ceiling Mount/Wall Mount)	36
2.10.1	Dimensions—Ceiling Mount	36
2.10.2	Dimensions—Wall Mount	36
2.10.3	Dimensions of the SecureFlex Mount's Foot	37
2.11	Mounting the MOBOTIX M12 to a Wall or Ceiling	38
2.11.1	Mounting to a Wall	38
2.11.2	Mounting to a Ceiling	38
2.11.3	Converting the Wall Mount to Ceiling Mount	39
2.12	Preparing the Installation	40
2.12.1	Insect Protection of the Camera	40
2.12.2	Connecting to the Network (Ethernet)	40
2.12.3	Connecting Another Cable (ISDN/RS232)	41
2.12.4	Inserting an SD Card (Optional)	41
2.13	Mounting the Camera	42
2.14	Mounting the Camera to Different Surfaces	43
2.14.1	Mounting to a Wooden Wall or Surface	44
2.14.2	Mounting to a Drywall	45
2.14.3	Mounting to a Concrete or Brick Wall	46
2.14.4	After Mounting the Camera	47
2.15	Installing the MOBOTIX SecureFlex Pole Mount	48
2.15.1	Delivered Parts of the SecureFlex Pole Mount	48
2.15.2	Mounting the Pole Mount and the Camera	49
2.16	Adjusting the Tele Lens Focus (Cameras With L135 Tele Lens Only)	51
3	OPERATING THE CAMERA	52
3.1	General Procedure	52
3.1.1	Establishing the Power Supply of the Camera	52
3.1.2	Connecting the Camera	52
3.2	Overview of the Configuration Settings	54
3.3	Connecting the Camera	56
3.3.1	Ethernet: Power Supply Using a Network Power Adapter (MX PoE)	56
3.3.2	Ethernet: Power Supply Using a Network Power Rack (MX PoE)	57
3.3.3	Ethernet: Power Supply Using PoE Products (Power over Ethernet)	58
3.3.4	ISDN: Power Supply Using a Network Power Adapter	59
3.3.5	ISDN: Directly Supplying Power Using the External Power Supply	60
3.3.6	Ethernet and ISDN	60
3.3.7	Camera Startup Sequence	61

3.4	The First Image from the Camera	62
3.4.1	Preparing the Ethernet Connection	62
3.4.2	Preparing the ISDN Connection	64
3.4.3	Simultaneously Using ISDN and Ethernet Connections (Gateway)	64
3.4.4	The First Image in the Browser	65
3.4.5	Additional Information	66
3.4.6	Camera Screens in the Browser	67
3.4.7	Access Using Zeroconf/Bonjour	68
3.4.8	The First Image in MxControlCenter	72
3.5	Starting the Camera With an Automatic IP Address (DHCP)	78
3.6	Starting the Camera Using the Factory IP Address	79
3.7	Connecting External Devices and Sensors: MX Interface Connector and MOBOTIX Cam-IO	80
3.7.1	MX Interface Connector for Direct Connections	80
3.7.2	MOBOTIX Cam-IO: Expansion Module for Easy Installation	81
3.8	Signal Input/Output, RS232 Interface	82
3.8.1	Signal Input Pins	82
3.8.2	Signal Output Pins	83
3.9	M12 Drilling Templates (Scale 1:1)	84

**APPENDIX: HARD- AND SOFTWARE FEATURES
IP65 CERTIFICATE, DECLARATION OF CONFORMITY
M12 DRILLING TEMPLATE**

Note

The following chapters (4 and higher) are all part of the **Camera Software Manual**. The main headings are listed below to give you an overview of the *Software Manual* contents.

SOFTWARE MANUAL PART 2

4	CAMERA USER INTERFACE
4.1	The First Image in the Browser
4.2	The First Image in MxControlCenter
4.3	Screens of the Camera
4.4	The Live Screen in the Browser
4.5	The Playback Screen in the Browser
4.6	The MultiView Screen in the Browser
4.7	PDA Screen
4.8	Guest Screen
4.9	Browser Settings

4.10 Configuring the Softbuttons

4.11 Fast Video Streaming

4.12 Operating Multiple Cameras

5 BASIC CAMERA CONFIGURATION

5.1 Overview

5.2 Quick Installation

5.3 Connection Test

5.4 Basic Settings

5.5 Image Controls

5.6 Logos

5.7 Exposure Settings

5.8 Day & Night Modes

5.9 Managing Settings

6 SOFTWARE UPDATES

6.1 Overview

6.2 Preparatory Steps

6.3 Updating the Camera Software

6.4 Update Checklist

7 EVENTS, ACTIONS AND MESSAGES

7.1 Overview

7.2 Functional Overview

7.3 General Remarks on Operating the Camera

7.4 Screen Display of Event Settings in Live Image

7.5 Arming

7.6 Events

7.7 Actions and Messaging, Action and Messaging Profiles

7.8 Working with Profiles

7.9 Time Tasks

8 RECORDING

8.1 Overview

8.2 Recording Modes

8.3 Recording Types

9 TELEPHONY FEATURES

- 9.1 Overview
- 9.2 VoIP Settings for IP Telephony
- 9.3 Camera Phone (Listen, Speak and Intercom Modes)
- 9.4 Phone Profiles: Outbound Phone Calls
- 9.5 Voice Dial-In: Inbound Phone Calls
- 9.6 Remotely Controlling the Camera Using a Phone
- 9.7 Sample Configurations for IP Telephony via Internet
- 9.8 Sample Configurations for IP Telephony via LAN

10 MOBOTIX CAMERAS ON THE WEB

- 10.1 Overview
- 10.2 Displaying Cameras on the Web
- 10.3 Configuring Routers and Firewalls
- 10.4 Configuring DynDNS
- 10.5 Updating Web Pages

11 SOFTWARE INTERFACES

- 11.1 Overview
- 11.2 Accessing Live Images
- 11.3 Accessing the Second Image Channel
- 11.4 Video Streaming
- 11.5 The HTTP API

12 TROUBLESHOOTING

Information subject to change without notice!

Copyright © 1999-2007 MOBOTIX AG, Kaiserslautern, Germany.

All rights reserved. MOBOTIX, MxPEG and MxControlCenter are worldwide trademarks of MOBOTIX AG. Microsoft, Windows and Windows Server are registered trademarks of Microsoft Corporation. Apple, the Apple logo, Mac, Mac OS X and Bonjour are trademarks of Apple Inc. Linux is a trademark of Linus Torvalds. All other marks and names mentioned herein may be trademarks or registered trademarks of the respective owners.

Further information:
www.mobotix.com

1 INTRODUCTION



30 frames per second!

The M12 camera range represents the next model of the second generation of MOBOTIX network cameras. Now more powerful than ever, the new models are capable of creating high-resolution live video streams with high frame rates. When showing **VGA video (640x480)**, the camera can deliver up to **30 fps**. Even **Megapixel video (1280x960)** will still generate up to **10 fps**. The camera transmits realtime sound from the microphone, even in the browser.

Similar to previous MOBOTIX cameras, M12 cameras are available as **SECURE, IT, WEB** and **BASIC** models with differing software features. The WEB and BASIC models do not have a microphone. The M12 can be fitted with three M14 high-performance lenses; additional lenses will be available in the future.

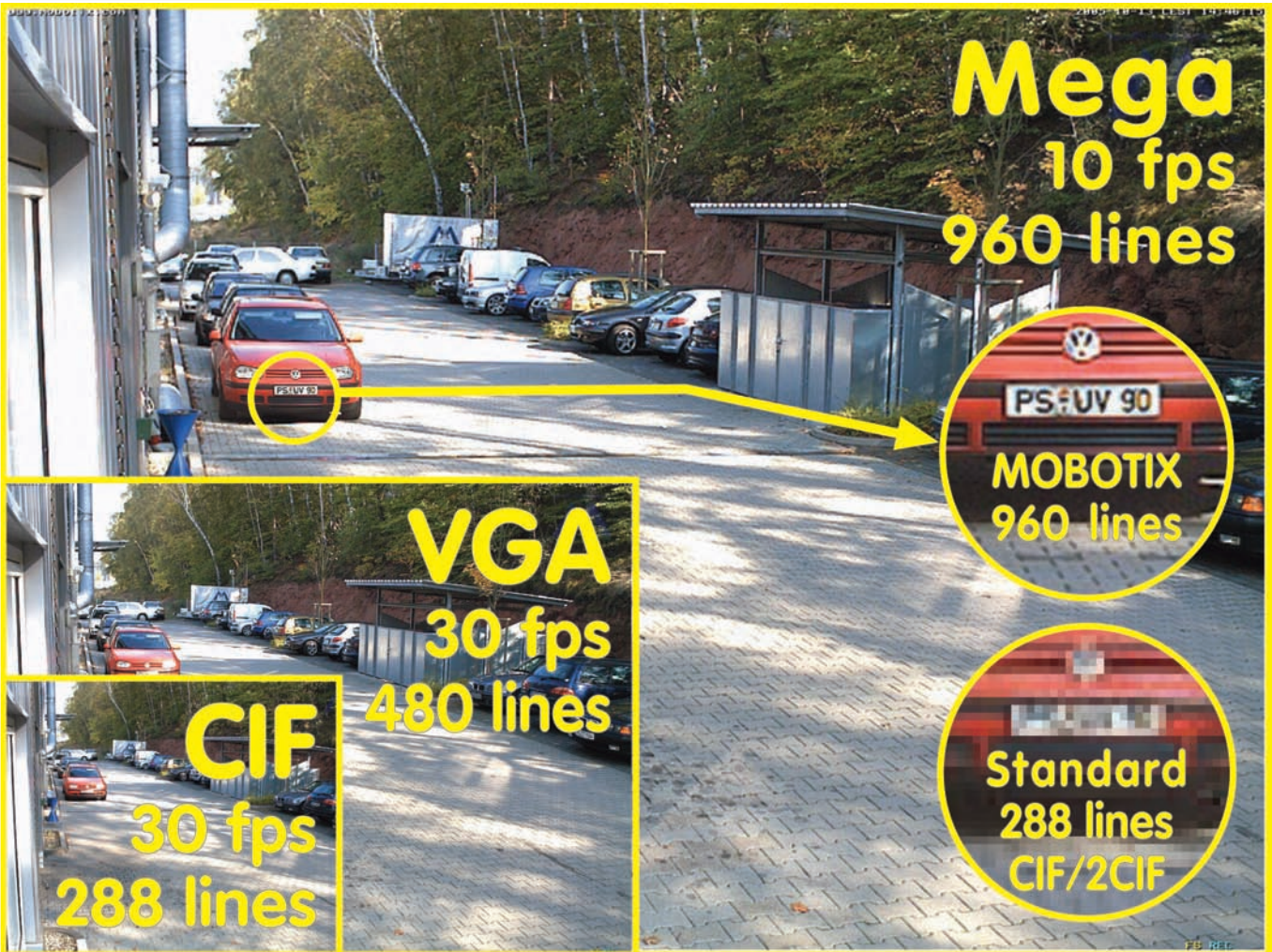

Everything integrated!

Like all other MOBOTIX cameras, M12 models are more than "just a camera"; the integrated software features (Secure/IT models) include a multitude of functions, such as **video motion detection, long-term recording, alarm messaging** and **video IP telephony**. In comparison to camera systems from other manufacturers, buying and installing additional software on the computer is thus unnecessary. Instead of using a web browser, you can also download the free **MxControlCenter**

for Windows from www.mobotix.com, which allows displaying multiple cameras on one monitor. Moreover, MxControlCenter can also process incoming alarms from the camera and allows for comfortably searching and evaluating the alarm video clips (including audio).

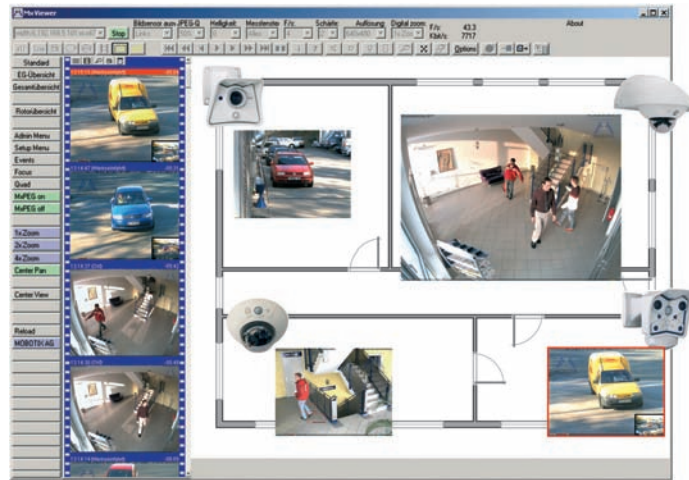

MxControlCenter

Because of the low power consumption of only 3 Watts, the MOBOTIX M12 cameras feature the highest operating temperature range in the market from **-30 to +60°C (-20 to 140°F)**. Since MOBOTIX cameras neither fog up nor require heating, power can be supplied using standard PoE products. All models come with a wall mount that covers wall outlets and perfectly conceals the cabling.

Using the new **MX Interface Connector** with D Sub 15 HD socket, you can directly connect external lamps, devices, sensors, microphones and audio amplifiers. The **MOBOTIX Cam-IO** expansion box simplifies installing the camera and expands on these possibilities: All external devices, sensors and the Ethernet cabling are connected directly to the installation box. Likewise, the **MOBOTIX Cam-IO** installation box hooks up to the mains and supplies power to the camera, without requiring any other type of power supply.

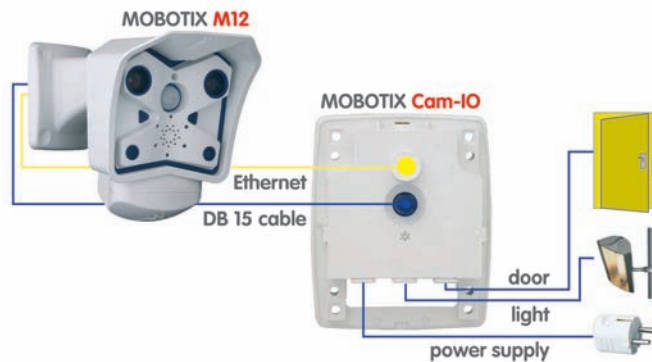

MOBOTIX Cam-IO

1.1 MOBOTIX Cost Benefits

1**Increased resolution reduces amount of cameras needed**

960-line, high-resolution sensors give a better overview and allow monitoring an entire room with just one camera from the corner

2**Reduced installation costs at any distance**

Standard Ethernet connection enables the use of common network components such as fiber, copper and wireless (WLAN)

3**Intelligent recording technology reduces required storage**

Decentralized recording technology in the camera software puts less strain on PCs and reduces the amount of storage PCs (DVRs) by 10 times

4**Event-controlled image rate minimizes storage costs**

Event-driven, automatically adjusted recording frame rate based on event or sensor action reduces amount of data and storage costs

5**No additional power and no heating required**

Anti-fogging without heating allows usage of standard PoE technology to power the system via network and saves costs of power cabling

6**Backup power requirement reduced by 8 times**

Low power consumption, 3 Watt, enables year-round (no heating required) PoE with one centralized UPS from installation room via network

7**Robust and practically maintenance free**

Fiberglass-reinforced composite housing with built-in cable protection and no mechanical moving parts (no autoiris) guarantees longevity

8**No software and no licence costs**

Control and recording software is integrated in the camera and is free of charge; new functions are available via free software downloads

9**Unlimited scalability and high return of investment**

While in use, more cameras and storage can be added at any time; image format, frame rate & recording parameters can be camera specific

10**Additional functions and other extras included**

Audio support, lens, wall mount and weatherproof housing (-30° .. 60°C; -22° .. 140°F) are incl.; microphone & speaker available in certain models

1.2 MOBOTIX Technical Advantages

- 1 Progressive-scan instead of half-frame blur**
Mega pixel sensor and image processing inside camera with digital white balance generates sharp and true color images at every scale
- 2 Sun and backlight compensation**
CMOS-sensor without autoiris, digital contrast enhancement and configurable exposure measurement zones guarantee optimal exposure control
- 3 Dual camera technology: 2-in-1**
Two possible camera views with picture-in-picture technology or 180° panoramic view; one Dual-Fixdome camera with 2.5 megapixel is enough
- 4 Long-term, high-performance Terabyte recording included**
Event detection and ring buffer recording by the camera itself allow recording of 40 smooth video streams on a single PC (1200 VGA images/s)
- 5 Simultaneous recording, event search and live viewing**
Live video for multiple users, recording and event search simultaneously possible in seconds from anywhere in the world via network
- 6 Very low network load**
Efficient MxPEG video codec, motion detection based recording and video buffering inside camera guarantee a very low network load
- 7 Bridging of recording during network failures**
Internal camera ring buffer bridges network failures and bandwidth fluctuations of wireless links (WLAN/UMTS) for several minutes
- 8 Day & night maintenance free**
Unique Day/Night camera technology without moving parts guarantees extreme light sensitivity and ensures long-term reliability
- 9 Audio and SIP telephony**
Lip-synchronized audio (live & recording); each camera is a video IP telephone based on SIP standard with automatic alarm call and remote control
- 10 MxControlCenter control center included**
Dual screen technology with building plans, free camera positioning, event search, image processing, lens distortion correction and PTZ support

1.3 The Concept Behind the MOBOTIX M12

High-Resolution Live Video (640x480) with up to 30 Frames/s

The second generation of cameras from MOBOTIX now delivers smooth live video display in VGA format with synchronous live audio, yet it keeps the network load to a minimum (approx. 2 Mbps). Live video display now match the performance of analog video systems. When recording, MOBOTIX systems easily outperform analog systems, since MOBOTIX cameras store the same resolution and quality with the same frame rates as in the live display. MOBOTIX technology thus allows **simultaneously** recording the video from **30 cameras in continuous recording mode on one standard PC at 30 fps each, including the audio channel** of the cameras.

Low Bandwidth Requirements

MOBOTIX' patent pending **MxPEG** streaming format allows fast live video with audio at extremely low network load (1 to 2 Mbps). Since the MOBOTIX camera itself detects movements in the image, video is only transmitted if movements occur, and when the video and audio data are stored.

Voice over IP and ISDN

Moreover, **MxPEG** provides for synchronized audio and two-way communication between the camera and your computer. Room surveillance with audio is possible using Internet Explorer or MxControlCenter. Alarm notification on your mobile via Internet (SIP) or ISDN telephony is just as easy as event-controlled voice messages directly from the camera.

IP Telephony and Video SIP

All telephone features can be used via Internet telephony thanks to the integrated SIP client. The SIP client allows remote-controlling the camera using the touchtone keys and also places the alarm calls of the camera. Video SIP establishes audio/video connections to the camera using Windows Messenger or similar applications (e.g. Counterpath x-Lite/eyebeam).

Long-Term Storage Included

MOBOTIX cameras have an integrated long-term storage system for Linux, Windows and Mac OS X computers. Every camera manages its own storage space as a ring buffer on the shared folder. Thanks to this decentralized approach, 30 live cameras can store images on a regular Pentium 4-class computer with **30 fps each**, including audio (also depends on the operating system).

Event Storage on SD Card

An SD card can be inserted into the integrated slot to increase the internal memory of MOBOTIX M12 cameras (SD cards will be supported after a software update, (available in future versions). A 2GB card can permanently store up to 65,000 images in CIF format, 40,000 images in VGA format or 13,000 Megapixel images,

IP Telephony!

which are not lost in the event of a power failure. If long-term storage on a file server has been set up, the SD card adds yet another layer of security against loss of data, as the SD card can easily bridge longer network outages.

30 Live Cameras Using MxControlCenter

The free **MxControlCenter** Windows client for viewing up to 30 MOBOTIX cameras with audio now features an integrated layout editor for quick assembly of building plans-using full drag&drop support for positioning the live camera images. Load a floor plan as background image, drag&drop the cameras; done.

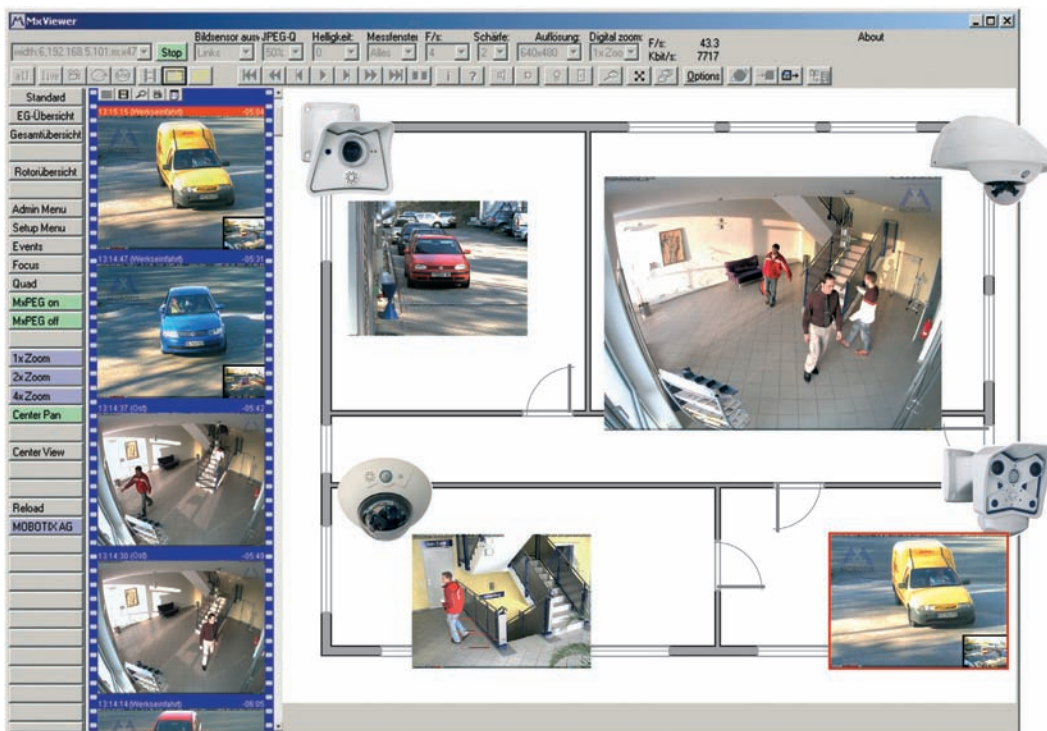

Download MxControlCenter free of charge from www.mobotix.com

Event and Time-controlled

Just like event-controlled recording upon detecting movements in the image, the camera can also record when the volume picked up by the microphone exceeds a set trigger value. Using scheduled recording, time tasks can start or stop video recording, uploading of images to a web site or sending of emails with video/audio clips. Special programs control vacation times and holidays.

Remote Alert Popup

In case of an alarm, MOBOTIX cameras automatically pop up windows or activate other functions at a remote security control center. The cameras can use network/wireless, GSM/GPRS/UMTS (3G) or Internet connections for this purpose.

Day & Night

MOBOTIX Night models with two image sensors (color and B/W) deliver brilliant color images during the day and crisp B/W images at night. Cameras switch lenses automatically, depending on the illumination.

Integrated Power over Ethernet

Power is supplied via the network cables using either MOBOTIX **Network Power Adapters with power supplies** or the Network Power Racks (4/8/20 cameras per rack) or devices that supply **PoE according to IEEE 802.3af**. Since the camera's plastic housing insulates well and does not fog up, no additional heating or fans are necessary. This is why MOBOTIX cameras have low power requirements (3 Watts) and can be operated every day of the year indoors as well as outdoors and why PoE can be used for supplying power—unlike in other cameras.

Weatherproof

MOBOTIX M12 cameras are certified according to IP65 and are designed for outdoor as well as indoor usage. As the cameras do not have any moving parts, they are extremely robust and resistant against heat or cold (-30°C to +60°C; -20°F to +140°F).

Secure and Flexible Installation Using the SecureFlex Mount

The **SecureFlex wall/ceiling mount** (standard delivery) provides easy mounting of the MOBOTIX M12 to a wall or ceiling and also allows positioning the camera into virtually any direction, while the concealed cabling enhances the visual impression of the installation. The mount completely covers wall outlets and allows using a defined network end point, thus facilitating the installation.



Expanded Connections—MX Interface Connector D Sub 15 HD

Depending on your requirements, you can connect additional sensors via the **D Sub 15 HD** socket, allowing you to expand the range of sensors already in the camera. Likewise, you can use the signal outputs of the camera to switch external devices or to trigger external devices, such as alarm systems. This socket also provides a Line In pin, a Line Out pin, power supply for USB devices, USB master data signals and a pin for connecting a backup power supply, which can also be used by solar panels.

No heating required -
PoE is no problem even
in the wintertime!

Covers RJ45 wall outlets
and conceals the cabling

Easy Installation Using the Cam-IO Installation Box

The **Cam-IO Installation box** greatly facilitates setting up a security system as this module carries all pins of the **MX Interface Connector** and simplifies connecting external devices and sensors. Besides supplying power to the camera, the installation box can power lamps with up to 500 W/230 V (max. 4 A) and has heavy-duty connectors for the remain-ing pins of the **D Sub 15 HD** socket (e.g. Line In/Out or signal inputs of the camera).

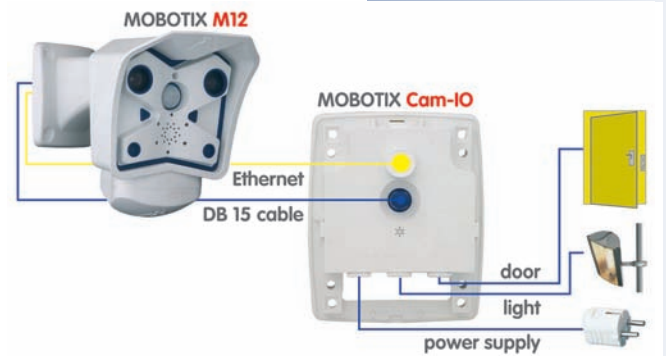

Logos, Animated or Freestyle

The Logo generator of MOBOTIX cameras allows integrating different banners and graphics (including files loaded from any URL) into the current camera images—with optional scheduler control. MOBOTIX cameras are the only network IP cameras supporting animated and transparent graphics.

Logo generator integrated



1.4 Product Advantages of the MOBOTIX M12

- MOBOTIX M12 camera models support the Power-over-Ethernet **standard IEEE 802.3af** as well as MOBOTIX PoE technology.
- **Individual lens configuration** possible:

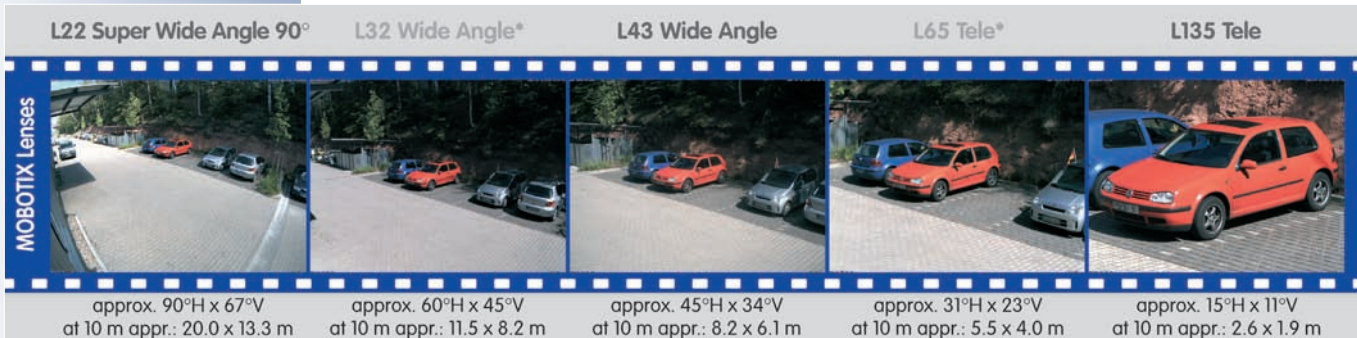

* not available for M12

- Internal memory can be expanded using non-volatile **SD cards** (available in future versions after updating the software).
- Optional **Wireless** or **UMTS/3G** functionality thanks to **CF cards** (only installed by MOBOTIX; available in future versions).
- High image quality with **max. 1.3 M pixels** resolution. The proven MOBOTIX software scaling delivers crisp images even for the smaller formats (PDA, CIF, VGA).
- Fully browser-based—**no software installation** required.
- Simple connection to IP network or **DSL using the integrated 10/100 Ethernet** interface, or **ISDN**.
- Camera configuration and playback of recorded images from any standard browser.
- **Synchronous audio** and **intercom features** when camera calls using integrated IP telephony or ISDN.
- Audio room surveillance using standard browser (Internet Explorer). The camera microphone can be irreversibly deactivated.
- **Minimal network load** thanks to innovative MxPEG compression scheme (patent pending).
- Integrated event-controlled and scheduled recording.
- Live recording of up to **30 cameras simultaneously with full 30 fps each, including audio on one standard PC**.
- No limitation regarding the number of cameras and storage media; the system is infinitely scalable.
- **Long-term storage of video** including audio or individual images in a freely selectable data storage (ring buffer) on a standard PC or file server.

- **Integrated data storage (ring buffer)** can bridge network failures of up to 4,000 images or 6 minutes video; this can be further expanded when using an SD card.
- Maintenance-free and **weatherproof from -30 to +60°C (-22 to 140°F)** because the system has **no moving parts**.
- Alarm notification via e-mail, SMS or phone call.
- **Backlight correction** with predefined and customized exposure areas.
- Professionally equipped with integrated sensors: **Video motion detection, microphone and speaker**.
- Flexibly positioned with **concealed cabling** and **covered wall outlets** thanks to SecureFlex mount (standard delivery).
- **D Sub 15 HD socket of the camera** allows connecting three signal inputs (e.g. external sensors), three signal outputs (e.g. alarm systems), Line In, Line Out, USB devices, power backup.
- Can be further expanded using **MOBOTIX Cam-IO**, which allows direct connection to door openers, lamps, sirens, an external microphone (with pre-amplifier), a loudspeaker, external sensors (e.g. light barrier). Hooks up directly to the mains and supplies power to the camera via the network cable to the camera (**PoE**).
- Free **MxControlCenter** for Windows to display and manage MOBOTIX cameras; includes alarm management, background images, etc.
- **Layout editor** in free-of-charge **MOBOTIX MxControlCenter** for quickly creating building layout plans with cameras.
- Platform-independent **SDK** allows developing applications; includes sample applications (MxPlayer, MxPEG-to-MJPEG converter) and sample source code.



1.5 Feature List

The MOBOTIX M12 includes the following main features (some features are model-dependent):

- **Live images** of up to 1280 x 960 pixels resolution via network, ISDN, GSM, GPRS, UMTS, wireless up to 30 fps (at 640 x 480 resolution), also adapted for **PDA**s.
- **Digital zoom** with three stages (1x, 2x, 4x) and integrated panning (from 2x: clicking in the browser image will move the visible image section in that direction).
- **True software scaling** using the proven and continuously improved MOBOTIX algorithms which delivers brilliant images even with smaller image formats (e.g. 320 x 240).
- **Audio video recording** with three different recording modes: Event recording with audio, continuous recording with variable frame rate and audio as well as event-controlled Snap Shot recording of JPEG images.
- **Telephony functions (SIP and ISDN)** for Phone Call-In and remote-controlling from touchtone phones as well as voice phone calls from the camera for alarm messaging purposes.
- **SIP Video** (Internet telephony) with support for e.g. Windows Messenger, x-lite/eyebeam and video phones.
- **File server tests** can monitor a file server and use one or more of the defined messaging options for error notification.
- **Camera tests** where several cameras monitor each other, with failure notification using the defined messaging options.
- **Playback** of recorded images/video sequences with audio in the integrated video management system.
- **MultiView** screen for displaying multiple cameras or events in one browser window.
- **Event notification** by e-mail, SMS (using a provider), voice notification by phone using pre-recorded messages, sounds and by visual alarms (e.g. red frame in Live image) using two separate messaging paths.
- **Object tracing** for analyzing the paths of objects that are moving in the image.
- **Logo generator** for displaying logos in the camera images with dialogs for managing image files, image and logo profiles for controlling logo display.
- **Logos** can have **transparent areas** and can be displayed partially transparent at the same time (creating a watermark effect), banner rotation and animations are also possible.

1280 x 960 pixels

Logo generator

- **Time Tables** for handling customized days, e.g. for holidays and vacations. The time tables are used to control the camera's arming, image recording, action, messaging, logo, obscure image and other features.
- **Remote signaling** for **master/slave** cameras, with the master camera controlling the arming status of the slave cameras. This allows arming all slave cameras using a key switch that is connected to the master camera.
- **Transfer profiles** for improved handling of FTP, E-Mail, phone calls, network transmissions and messages.
- Multiple possibilities for connecting external devices, sensors and signal lines using the **D Sub 15 HD socket** of the camera or the **MOBOTIX Cam-IO** installation box.
- **Speaker phone** with talk, listen and intercom modes via **Internet telephony (SIP) and ISDN** using the integrated microphone and speaker.
- **Phone Call-In** to remotely control the camera using a touchtone phone via **Internet telephony (SIP) and ISDN** (retrieve camera information, establish Internet connection, announcement of retrieved IP address, intercom feature, etc.).
- **MxPEG video compression** using **MOBOTIX MxControlCenter**. The ActiveX plug-in for Internet Explorer users brings all advantages of MxPEG (including the audio stream from and to the camera) to the browser-based user interface.
- **Routing** allows using other network connections besides the standard route.
- **DynDNS client** for accessing the camera using a symbolic name (e.g. `mymobotixcam.dyndns.org`) although the provider is assigning a new IP address every time the camera connects to the Internet.
- Inerasable **backup operating system** that is used to restart the camera in the event that a software update has failed, allowing you to restart the update process.
- **Enhanced startup options** for the camera (obtain IP address via **DHCP**, announcement of IP address and other network data, reset to factory default settings).

Software Updates

MOBOTIX provides **free** software updates on www.mobotix.com at regular intervals that improve and expand the camera's functionality. Chapter 6, *Software Update*, in the *Software Manual*, provides more information on the process.

Speaker phone

Telephony features using ISDN or SIP connections (Internet telephony)!

Free software updates on www.mobotix.com

1.6 MOBOTIX M12 Lens Options

MOBOTIX currently offers five different lenses with M14 thread from **Super Wide Angle** (L22) with 22 mm to **Tele** (L135) with 135 mm focal length (equiv. to 35mm camera). Since MOBOTIX cameras are backlight-proof, these lenses do not require an auto iris. Without the iris as a mechanical component, these glass lenses are extremely robust and maintenance-free.

You can choose between the following lenses for the MOBOTIX M12: **L22 Super Wide Angle 90°**, **L43 wide-angle** and **L135 Tele**. The **L22 Super Wide-Angle 90°** has very little distortion, even when using the 4x digital zoom of the M12. Mounting a camera with the Super Wide Angle lens in the corner of a room will allow you to see the complete room.



Super Wide Angle 90°

Lens Table					
Order name	L22	L32*	L43	L65*	L135
Original image					
Equiv. 35 mm camera	22 mm	32 mm	43 mm	65 mm	135 mm
Focal length	4 mm	6 mm	8 mm	12 mm	25 mm
F-Number	2,0	2,0	2,0	2,0	2,5
Image angle horizontally	90°	60°	45°	31°	15°
Image angle vertically	67°	45°	34°	23°	11°
Installed at 1 m	m	m	m	m	m
• Image width	2,0	1,1	0,8	0,5	0,3
• Image height	1,3	0,8	0,6	0,4	0,2
Installed at 5 m	m	m	m	m	m
• Image width	10,0	5,7	4,1	2,7	1,3
• Image height	6,6	4,1	3,0	2,0	1,0
Installed at 10 m	m	m	m	m	m
• Image width	20,0	11,5	8,2	5,5	2,6
• Image height	13,3	8,2	6,1	4,0	1,9
Installed at 20 m	m	m	m	m	m
• Image width	40,0	23,0	16,4	11,0	5,2
• Image height	26,6	16,4	12,2	8,0	3,8
Installed at 50 m	m	m	m	m	m
• Image width	100,0	57,5	41,0	27,5	13,0
• Image height	66,0	41,0	30,5	20,0	9,5

* not available for M12 models

1.7 Hard- and Software Differences of the MOBOTIX M10/M12

To cut a long story short – nothing changes with the basic functionality or the looks of the camera. Users, who have worked with M10 models before will not have any problems adjusting to a MOBOTIX M12.

Changing to the three times faster Intel "Bullverde" PXA270 processor with 520 MHz frequency has boosted image processing considerably, providing notably higher frame rates (up to 30 fps in VGA, up to 10 fps in MEGA resolution). The new hardware also brings new features, such as SIP video (Internet telephony with video) and new possibilities for extending the hardware (SD card, CF slots, MX Interface Connector, USB master pins for MOBOTIX expansion modules, etc.).

The following table shows the most important differences in the hardware and software:

	MOBOTIX M10	MOBOTIX M12
Hardware Differences		
Housing color	White, Gray	White
Wall/ceiling mount	Ball joint, SecureFlex mount for Secure models	SecureFlex mount covers RJ45 wall outlets and conceals the cabling (all models)
Lens options	Wide-angle L43, Tele 135	Super Wide-Angle L22 , wide-angle L43, tele 135
Ethernet interface	10 Mbps	10/100 Mbps
Serial interface	D Sub 9	D Sub 15 HD
USB connector	--	USB master on D Sub 15 HD (for MX expansion modules)
SD card*	--	SD card for extra storage
CF slots**	--	CF slots for MOBOTIX expansion modules (wireless, storage, ...)
Line In/Out pins for external audio devices	--	External microphones/PA systems via D Sub 15 HD
Backup power supply	--	Backup power (6 to 12 V, max. 1 A) on D Sub 15 HD
ISDN power supply	Power supply via ISDN NT	Not possible , but can be injected into 8-wire cable (split cable and power supply or PoE required)
PoE power supply	MOBOTIX PoE products (MX-NPA + power supply / NPR-4/8/20)	MOBOTIX PoE products and standard PoE IEEE 802.3af
Software Differences		
Frame rate (fps)	25 CIF • 12 VGA • 4 MEGA	30 CIF • 30 VGA • 10 MEGA
Image formats	CIF, VGA, VGA2, MEGA, Custom	CIF, VGA, VGA2, MEGA, Panorama , Custom
SIP video	--	SIP video

* Supported in future versions

** Supported in future versions. CF cards are only installed at the factory!

The only limitation versus the M10 is the power supply via ISDN cable, which is not possible any more. This can only be achieved using the MOBOTIX PoE products and the ISDN split cable

1.8 Important Notes

1.8.1 MOBOTIX M12-Weatherproof to IP65

The MOBOTIX M12 is **weatherproof according to IP65** (absolutely dustproof, resistant against water jets)! You can take additional measures for further improving the weatherproofness if the camera is exposed to extreme weather conditions:

- Make sure that the SecureFlex mount is **never** mounted as shown in figure (1)! This is even more important when you are mounting the camera on a pan/tilt head.
- Make sure that the SecureFlex mount is **always** installed as shown in figure (2)! Closely follow the notes and hints in section 2.11!
- The SecureFlex mount should be sealed off with additional silicone sealant as shown in figure (3). Make sure that the **drain holes** at the bottom of the mount remain open!
- Make sure the **blue insect protection plug** is firmly seated! Closely follow the notes and hints in section 2.12.1!
- Seal off the SecureFlex mount against the wall using silicone sealant.
- Make sure that the cabling always enters the SecureFlex mount from the bottom!
- **Only use genuine MOBOTIX cables** since they prevent water from entering the camera!

1.8.2 Password for the Administration Menu

The administration area of the camera (**Admin Menu** button) is protected by a user name and password:

- User name is **admin**
- Password is **meinsm**

Enter the user name and password exactly as shown above. Note that both entries are case-sensitive.

When accessing the administration menu for the first time, the **Quick Installation** wizard will help you set the most important parameters that are relevant for your requirements. **For security reasons, it is highly recommended to change the administrator password after the camera has been configured properly.**

CAUTION: Make sure that you store information on user names and passwords in a secure place. If you lose the administrator password and cannot access the Admin menu, the password can only be reset at the factory. This service is not free!



1



2



3

Administration menu:

User: **admin**

Password: **meinsm**

1.8.3 Password for ISDN Dial-In

Dialing into the camera via ISDN is protected by a separate password. When setting up a dial-in connection from a computer, you need to provide this information:

- User name is **linux**
- Password is **tux**

Enter the user name and password exactly as shown above. Note that both entries are case-sensitive.

1.8.4 Irreversibly Deactivating the Microphone

Deactivating a camera's microphone may become necessary in order to protect the privacy of people at a workplace or for other reasons. You can permanently and **irreversibly** deactivate the microphone in the **Admin Menu > Loudspeaker and Microphone** dialog.

CAUTION: This deactivation is permanent and cannot be reversed even by MOBOTIX engineers. Deactivating the microphone will also deactivate all features that use the camera's microphone.

1.8.5 Starting the Camera Using the Factory IP Address

If the camera's IP address is not known any more, you can start the camera with its factory IP address. Section 3.6, *Starting the Camera Using the Factory IP Address*, describes this procedure in more detail.

1.8.6 Resetting the Camera to Factory Defaults

All settings of the MOBOTIX camera can be reset to the factory default settings. This makes sense if you have, for example, obtained a camera without any information or you would like to reset all settings after testing the camera. In order to perform this procedure, you need to have access to the administration area of the camera (**admins** group). Open **Admin Menu > Reset ...** to reset the camera to factory defaults.

Note: In contrast to the method described in section 3.6, *Starting the Camera Using the Factory IP Address*, **all users will be deleted** (except the **admin** user) when resetting the camera to factory defaults. Likewise, the **admin user's password will be reset**.

1.8.7 Activating Event Control for Security Applications

In its default configuration, the camera's event control and video motion detection features are **not enabled**. In order to activate event control as a whole, open **Setup Menu > General Event Settings** and activate the **Arming** switch or click on the **Arm & Record** softbutton of the browser interface. The video motion detection window is visible again (dotted frame in the center of the live image) and the camera stores images as soon as the video motion window detects movements.

ISDN Dial-in
User: **linux**
Password: **tux**

The microphone can be irreversibly deactivated!

The configuration can also be reset partially

If the dotted rectangle in the live image is visible, the camera is armed

Text and logos can be also deactivated or customized to your liking

Deactivating the camera reboot

1.8.8 Deactivating Text and Logo Options

As the camera arming has been deactivated in its default configuration (see preceding section), the MOBOTIX camera only displays the text **WWW.MOBOTIX.COM**, the time stamp and the MOBOTIX logo at the top of the image. Once the camera arming has been activated, the text at the bottom of the live image (event, action and messaging symbols) will also appear.

If the camera is armed, you can deactivate the status text at the bottom and the text at the top left corner of the live image by setting **Text Display** in the **Setup Menu > Text & Display Settings** dialog to *Off*. Setting **Text Display** to *Date & Time* will only display the time stamp in the live image. In order to hide the logo in the live image, open **Admin Menu > Logo Profiles** and set **Logo Display** to *Disable*.

1.8.9 Deactivating the Daily Reboot of the Camera

In its default configuration, the MOBOTIX camera will automatically reboot every morning at 3:36 am. In very rare cases, external influences (e.g. radiation in high locations) can lead to camera malfunctions. The automatic reboot will refresh the camera's memory and will ensure proper operation without requiring any interaction on the part of the user.

Open **Admin Menu > Time Tasks** and deactivate or delete the *Reboot camera* task. This will prevent the camera from rebooting automatically.

1.8.10 ISDN Compatibility Note

This product is compatible with **Euro ISDN standard TBR3/TBR 3A1**.

Note: MOBOTIX offers special models for the Japanese market that support the Japanese ISDN standard. For additional information on this topic, see the Japanese section at www.mobotix.com.

1.8.11 Using Internet Browsers

Current Internet browsers (Internet Explorer, Netscape, Mozilla, Firefox, Safari, Konqueror, Opera, ...) with **JavaScript** enabled can show the camera's live images with their standard settings. Text-based browsers (e.g. lynx) cannot display the user interface and are *not* suitable for operating the camera.

Section 4.8, *Browser Settings*, contains more information on browser compatibility. Chapter 12, *Troubleshooting*, contains more information on how to track and remove errors when operating the camera.

1.8.12 Cleaning Instructions – Cleaning the Lenses

If a lens is dirty from the installation process, clean the lens using a lint-free cotton cloth.

1.8.13 Safety Notes for Operating MOBOTIX Cameras

Electrical surges can be induced by other electrical appliances, improper wiring, but also from the outside (e.g. lightning strikes to phone or power lines).

MOBOTIX cameras are protected against small **electrical surges** by numerous measures. These measures, however, cannot prevent the camera from being damaged when stronger electrical surges occur.

Special care should be taken when installing the camera **outside of buildings** for **protection against lightning**, since this also protects the building and the whole network infrastructure.

MOBOTIX recommends having MOBOTIX cameras installed only by specialists accustomed to installing network devices and having proper respect for the pertinent regulations regarding lightning protection and **fire prevention** as well as the current technology for preventing damages from electrical surges.

Section 2.4, *Wiring, Fire Prevention, Lightning and Surge Protection*, contains more information on these topics.

1.8.14 Maximum Cable Lengths

According to **UL regulations**, the length of the cable to a MOBOTIX camera must be limited to **140 feet** or less running outside of buildings. The installation must comply with articles **725** and **800** of the **National Electric Code**.

1.8.15 Additional Information

For more information on this topic, see the **News** and **Functional Overview** pages in the online help of the camera's browser interface. Click on the yellow  icon in the top right corner to open the camera's online help.

In order to get more information on the camera and its current configuration, open the Camera Status dialog by clicking on the yellow  icon in the top right corner of the camera's browser interface.

Another source of information on all dialogs and parameters of the MOBOTIX camera is the **Reference Manual** that you can download from www.mobotix.com. The Reference Manual consists of the MOBOTIX camera's online help in one PDF file.

 Camera Help

 Camera Status

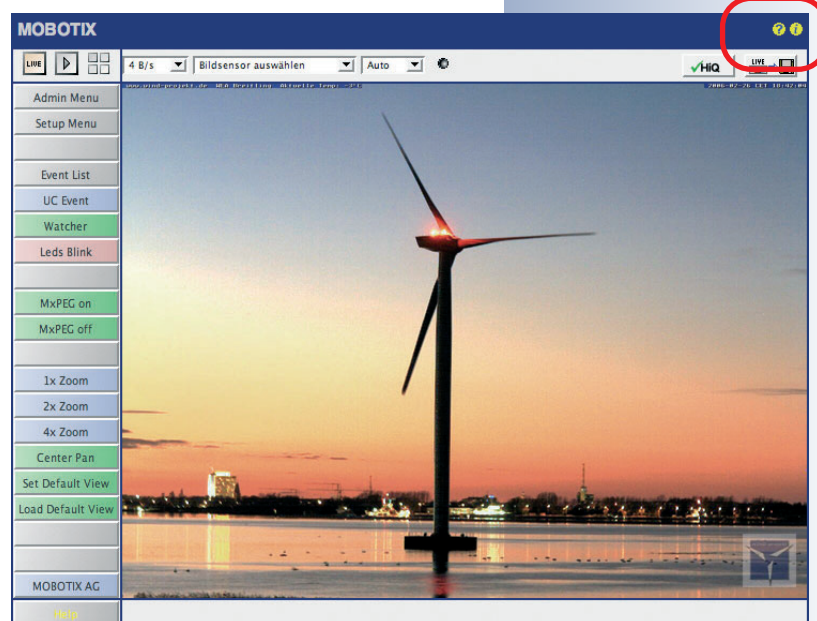

2 MOUNTING THE CAMERA

2.1 Delivered Parts, Camera Components and Dimensions

The MOBOTIX M12 is delivered with the **SecureFlex wall and ceiling mount** and is ready for use out-of-the-box.

2.1.1 Standard Delivery

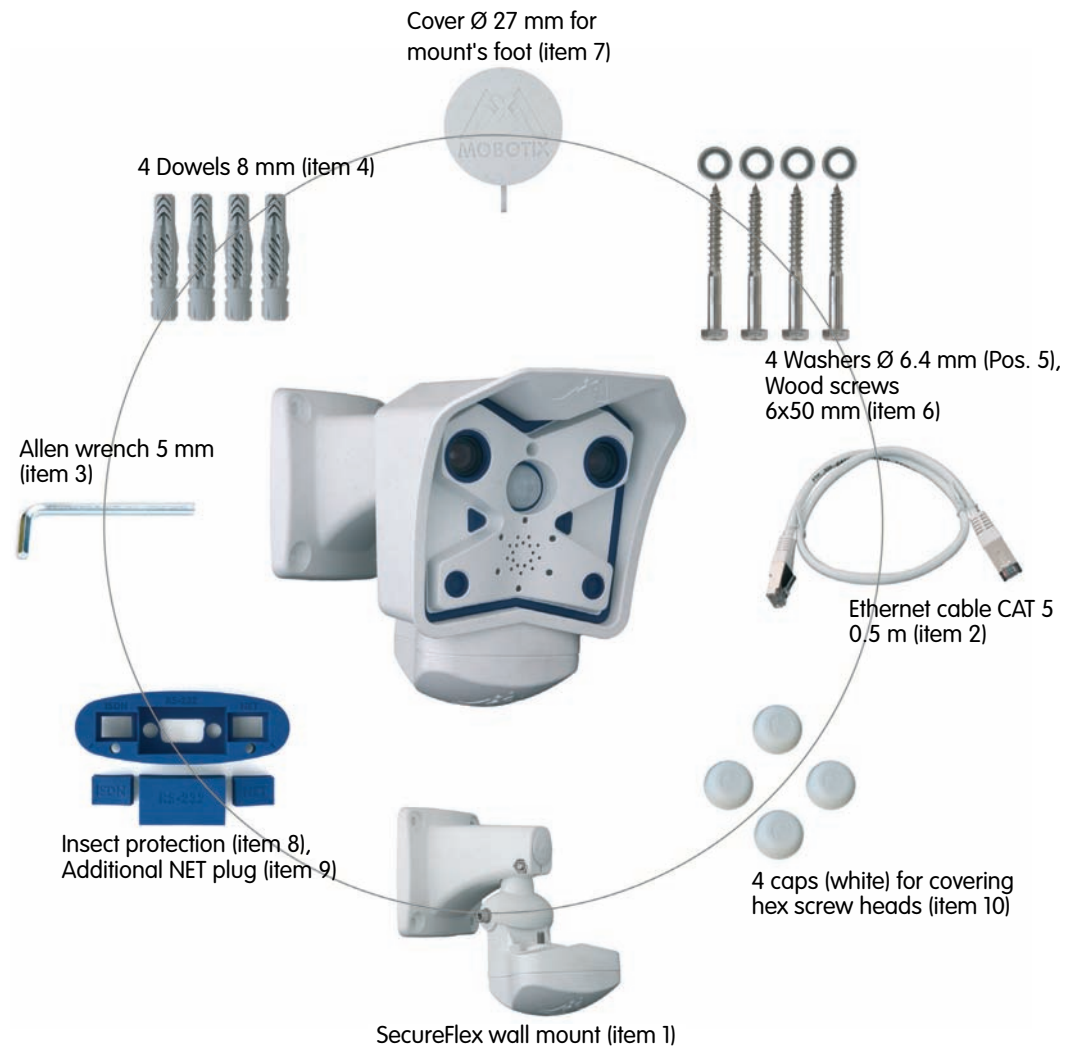

Make sure to check the delivered parts

Caution: Never use screws with countersunk heads to fasten the SecureFlex mount, as these screws will destroy the mount.



Item	Count	Part Name
1	1	SecureFlex mount for ceiling or wall
2	1	Ethernet cable CAT5 0.5 m/20", installed
3	1	Allen wrench 5 mm
4	4	Dowels 8 mm
5	4	Stainless steel washers Ø 6.4 mm
6	4	Stainless steel wood screws with hex head 6x50 mm
7	1	Cover Ø 27 mm for mount's foot
8	1	Insect protection (installed)
9	1	Additional NET plug for insect protection (Ethernet)
10	4	Caps (white) for covering hex screw heads

2.2 Camera Housing and Connectors

The MOBOTIX M12 camera housing is made of fiber-reinforced **plastic (PBT-30GF, Polybutyleneterephtalate with 30% fiberglass)**. This material is used heavily in the automotive industry and is sturdy, resistant against high temperatures, environmental influences, chemicals, etc.

Ultraviolet resistant: No yellowing of housing even after years of outdoor use

2.2.1 External Sensors

- PIR sensor
- Microphone
- IR remote control

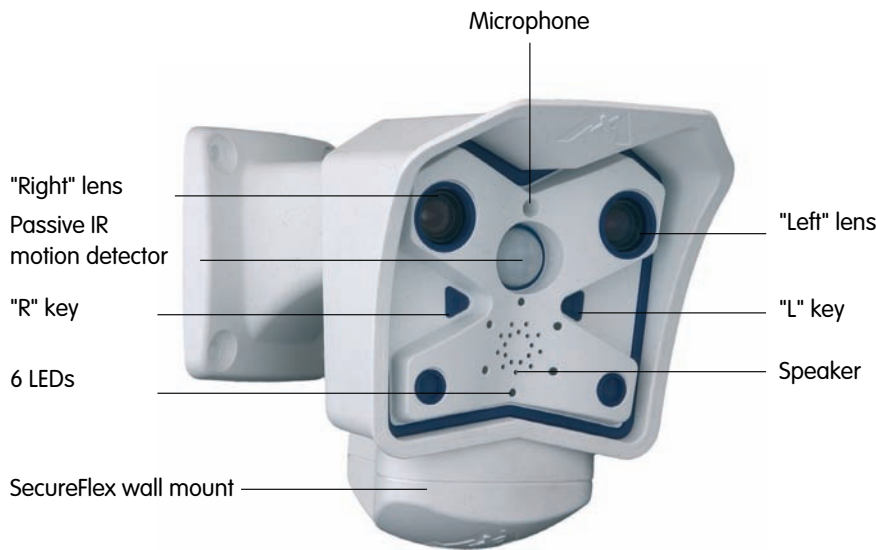

Signals of the camera LEDs:



- 0 On
- 1 Camera
- 2 Ethernet
- 3 Operating Mode
- 4 ISDN/VoIP
- 5 Camera

2.2.2 Connectors

- NET/10BaseT (Ethernet network) / power supply
- In/Out / RS232 / MX Interface Connector D Sub 15 HD
- ISDN
- Slot for SD card

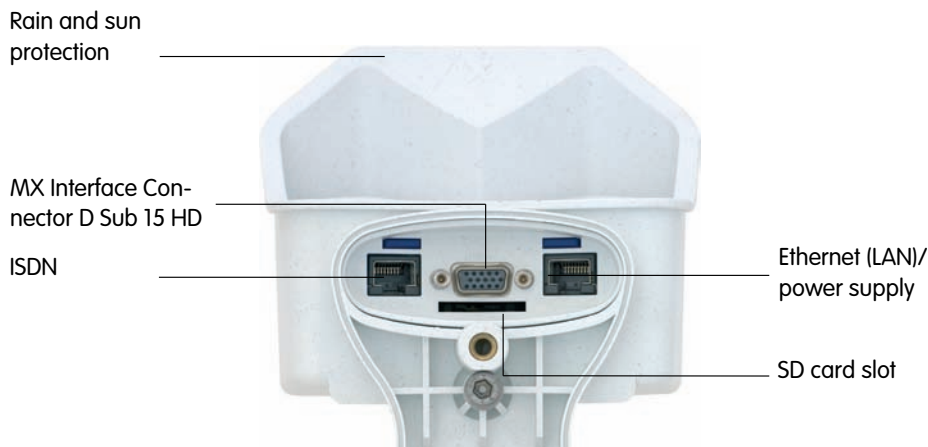

MX Interface Connector for attaching Cam-IO or external sensors, audio amplifiers, etc.

Not required if network components are used that support the PoE (Power over Ethernet) standard IEEE 802.3af!

Power supply for smaller systems

Intelligent and robust power supply thanks to DIN rail installation

Zero maintenance and reliable as these devices do not require fans

2.3 Optional Accessories

Power supply (MX-SNT-E/U/GB/J/AUS01-30-RJ)

The MOBOTIX power supply is required if you do not use a **Network Power Box** or **Network Power Rack** (see below), or a PoE-compatible switch or router.



Network Power Adapter (MX-NPA-3-RJ)

The Network Power Adapter allows injecting the power supply for the MOBOTIX camera into the network cable. It thus allows using a single cable for connecting to the camera and for remotely supplying power (up to 100 m/300 ft). The Network Power Adapter is required, if you are using the universal power supply and the SecureFlex mount, and power is not supplied using a PoE switch/router or a MOBOTIX Network Power Box/Rack.



Network Power Box for up to 4 Cameras (MX-NPR-4)

The MX-NPR-4 allows supplying power to up to four MOBOTIX cameras via the network cable. The NPR-4 thus replaces four separate power supplies and four Network Power Adapters. The Network Power Box delivery includes a (detachable) clip at the back, which simply clicks onto DIN rails.



Network Power Rack for 8/20 Cameras (MX-NPR-8/20)

The MX-NPR-8/MX-NPR-20 allow supplying power to up to 8/20 MOBOTIX cameras, respectively, via the network cable. These NPRs thus replace 8/20 separate power supplies and the same number of Network Power Adapters; they are easily mounted in 19" racks (2 rack units).



Advantages of the MOBOTIX PoE Products

- Zero maintenance and reliable as the systems do not require fans.
- Higher reliability of the system as a whole, since standard switches without PoE can be used (lower risk of failure).
- Easy installation on DIN rails (*MX-NPR-4*) or in 19" racks (*MX-NPR-8/20*).

SecureFlex pole mount (MX-MH-SecureFlex-ESWS)

If you are intending to mount the camera on a pole, you should consider using the SecureFlex pole mount, which is made of **3 mm stainless steel (white, powder coated)** and which has been designed specifically for outdoor usage. The supplied stainless steel straps allow attaching the mount to poles with diameters between 60 and 180 mm (2.4" to 7.1").



SecureFlex Pole Mount:
Outdoor quality made of
3 mm stainless steel

MOBOTIX Cam-IO (MX-CAM-IO)

This installation module for MOBOTIX cameras features numerous connectors for external devices. It thus expands the scope of camera applications when adding external sensors using its two signal inputs. On the other hand, it also allows controlling other devices (two signal outputs, Line In/Out for audio signals) and serves as power supply of the camera.

For additional information on the MOBOTIX Cam-IO, see section 3.7.2, *MOBOTIX Cam-IO: Expansion Module for Easy Installation*.



Expansion box with
various possibilities for
attaching external devices
and sensors

Split cable for ISDN-only power supply

If only ISDN is available for the camera and only one cable should be used for connecting the camera, you will need to inject power into the 8-wire cable using either a **power supply** and the **Network Power Adapter** or an **MX-NPR-4/8/20**.

Power injection into **one**
cable when using only
ISDN

2.4 Wiring, Fire Prevention, Lightning and Surge Protection

When installing the wiring inside or outside of buildings, make sure you always adhere to the relevant regulations on wiring, fire prevention and protection against lightning.

MOBOTIX recommends having MOBOTIX cameras installed only by specialists accustomed to installing network devices and having proper respect for the pertinent regulations regarding lightning protection and **fire prevention** as well as the current technology for preventing damages from electrical surges.

Find more information at an institution such as the **International Electrotechnical Commission** (IEC, www.iec.ch) or at a manufacturer of protection devices against lightning and electrical surges, such as Dehn (www.dehn.de).

2.4.1 Wiring

When installing the wiring, make sure you follow these guidelines:

- **Data cable:** Make sure to use only double-shielded CAT 5/7 cable (**S/STP**) for Ethernet connections (see section 3.3, *Connecting the Camera*).
- **Outdoors:** Installing the camera outdoors requires special precautions and measures regarding the cables as well as lightning and surge protection (see section 2.4.3, *Lightning and Surge Protection*).
- **Wire lengths:** The cable segments must not exceed the maximum allowed cable lengths in order to ensure proper data transfer (see section 3.3, *Connecting the Camera*).
- **Avoid induction:** When running data cables parallel to existing regular power lines or high-voltage wires, make sure you observe the minimum distances to the power cables.



2.4.2 Fire Prevention

When installing the power lines to the camera, make sure you always adhere to the relevant regulations on wiring and fire prevention at the site of the installation.

2.4.3 Lightning and Surge Protection

To prevent damage from lightnings and surges, make sure you follow these guidelines:

- **Lightning conductors:** In areas exposed to lightning (e.g. on roofs), a distance holder (1 m/3 ft. higher, 1 m/3 ft. away from the camera) and proper lightning conductors need to be installed in order to prevent lightning strikes into the camera and to ensure that the energy of a lightning strike is properly led to the ground.

- **Surge protection:** Make sure you have installed proper protection against electrical surges in order to prevent damage to the camera, the building and the network infrastructure. This includes surge protectors for 19" racks, adding an uninterruptible power supply (UPS) to the MOBOTIX camera, and installing surge arresters or similar for routers, switches, servers, etc.

2.5 Providing the Connections (Network/ISDN)

First, decide on which camera connections you would like to use.

Network is key

In general, you should always provide a **network connection**, if technically possible (a WiFi connection using a **bridge** or similar would also be acceptable), since a network connection brings a number of advantages:

- The highest **frame rate** is only reached if the bandwidth is high enough; ISDN and GSM/GPRS will *not* suffice to deliver smooth video images.
- The camera's **external ring buffer** (storing the video/audio data on a file server) can only be used via a network connection.
- Compared to the **costs** of dial-up connections (ISDN, GSM/GPRS), the costs for file transfers and other accesses by and to the camera are reduced considerably when using a network that is already up and running.
- **Software updates** are best accomplished using a network connection, if dismounting the camera is not an option.

SIP telephony reduces costs

ISDN connection of MOBOTIX cameras is not required if the network permits SIP connections for Internet phone connections. Thanks to the **SIP capabilities of the MOBOTIX M12** (see chapter 9, *Telephony Features*, in the *Software Manual*), the camera can place voice calls (e.g. for alarm notification) via the network and can also accept incoming voice calls via Internet telephony. You can call the camera from a phone to obtain the time and date of the last event, for example.

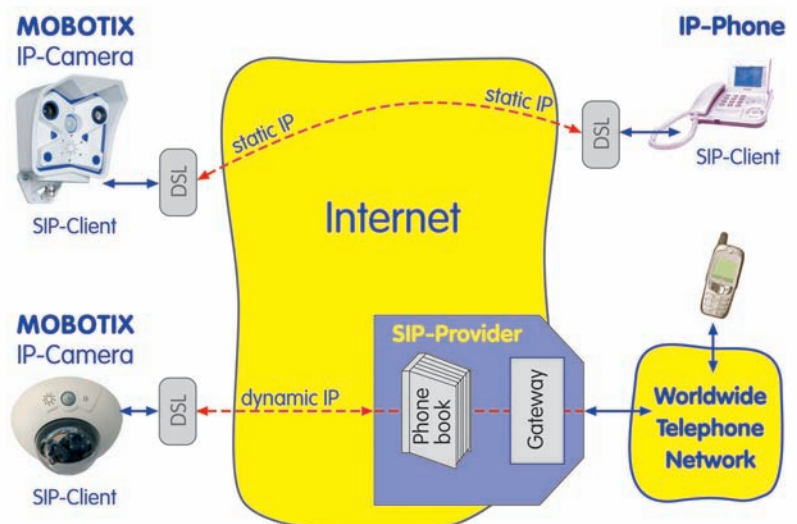

Always use the network, if possible

Free software updates!

Internet telephony

ISDN operation:

- Euro ISDN
- Japan
- (USA not supported)

The M12 supports the MOBOTIX PoE products for power injection into the network cabling and the Power-over-Ethernet standard IEEE 802.3af

MX-NPA-3-RJ: Easy installation for smaller systems

MX-NPR-4: For mounting in wiring cupboards; includes DIN rail clip

MX-NPR-8/20: 19" rack mount (2 rack units)

ISDN-only operation

When operating the camera only at the ISDN, you need to install an additional ISDN cable (see section 2.12, *Preparing the Installation*), then attach the power supply using the pre-installed cable and the **NET/10BaseT** connector of the camera.

Caution

In contrast to the MOBOTIX M10, it is not possible to use an ISDN NT and the S0 bus to supply power to the M12. Using the ISDN split cable and MOBOTIX PoE products (see section 2.3, *Optional Accessories*), the power can be injected into the ISDN data cable (8-wire cable required).

2.6 Power Supply of the MOBOTIX M12

In order to reduce the amount of cabling, you should always use the Ethernet cable (**NET/10BaseT**) to inject power into the camera cabling (**Power over Ethernet**).

For smaller installations, the MOBOTIX **Network Power Adapter** *MX-NPA-3-RJ* and the universal **power supply** *MX-SNT-E/U/GB/J/AUS01-30-RJ* is sufficient. Larger installations would benefit from one or more MOBOTIX **Network Power Boxes/Racks** that are available for supplying power to 4, 8 or 20 cameras (*MX-NPR-4, -8 or -20*). See section 2.3, *Camera Accessories*, for more information on these and other items or open shop.mobotix.com (**Products > Accessories** section).



Network Power Adapter
MX-NPA-3-RJ



Network Power Box
MX-NPR-4



Network Power Rack
MX-NPR-8/20

Advantages of the MOBOTIX PoE Products

- Zero maintenance and reliable as the systems do not require fans.
- Higher reliability of the system as a whole, since standard switches without PoE can be used (lower risk of failure).
- Easy installation on DIN rails (*MX-NPR-4*) or in 19" racks (*MX-NPR-8/20*).

Since the MOBOTIX M12 supports **Power over Ethernet (IEEE 802.3af)**, you can also use PoE switches or routers for supplying power.

Section 3.3, *Connecting the Camera*, contains more information on the possible combinations of connections and power supply options.

Note

If you are using **Power over Ethernet (IEEE 802.3af) network components** for supplying power to the MOBOTIX M12, make sure that these components do not have a fan. Since the power consumption of MOBOTIX cameras is very low compared to other products, this increases the reliability of the entire system and expands the life cycle of these components.

PoE components without fans increase overall reliability of the entire system

2.6.1 Using Uninterruptible Power Supplies (UPS)

In order to maintain a continuous power supply even when utility power fails, you should install an uninterruptible power supply (UPS). These devices also provide full protection against electrical surges and voltage fluctuations and thus enhance the reliability of the system as a whole.

When using more powerful 19" rack-mounted USPs, you can also protect all other network components (e.g. switches, routers, PoE switches, etc.).

Since MOBOTIX cameras do not require any heating even in the wintertime, the power consumption of 3 W is quite low. This in turn means that you can centralize the USP-protected power supply by injecting power into the network cables (max. 100 m/300 ft.). This kind of protected power supply can be used either with MOBOTIX PoE products (MX-NPA-3-RJ plus external power supply or MX-NPR-4/8/20) or with PoE-compliant switches according to IEEE 802.3af.

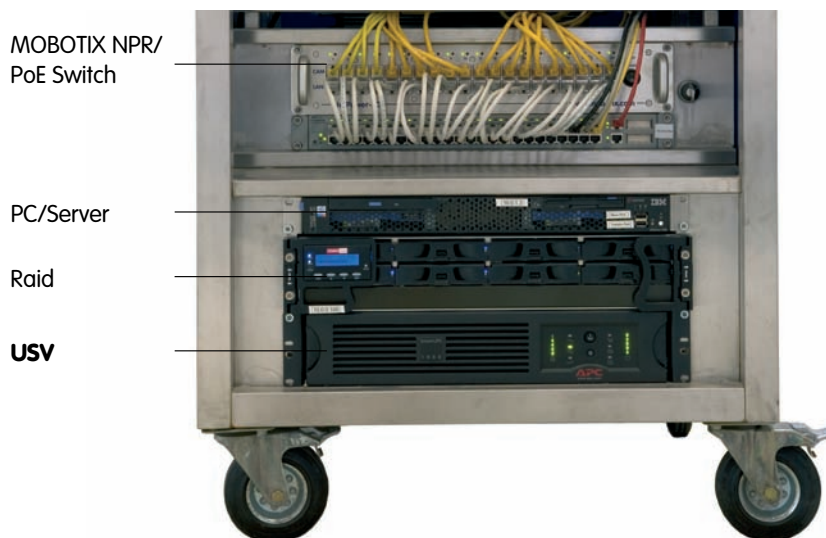

2.7 Determining Where to Mount the Camera

Before attempting to mount the camera to a wall or ceiling, make sure that you have found the best camera position. It is important that the camera's field of view is not obstructed in any way.

Once the camera has been mounted to a wall or ceiling, you can fine-tune its position. Thanks to the design of the SecureFlex mount, the camera can be turned horizontally and tilted vertically until the built-in stops are reached.

The camera can be **turned/tilted** within the following ranges (see section 2.11, *Mounting the MOBOTIX M12 to a Wall or Ceiling*):

- **horizontally**: approx. 180°
- **vertically**: approx. 70°

When using a wall outlet, the mounting position should be set in such a way that the wall outlet touches the upper rim of the mount's foot.

Caution: When using a wall outlet for an outside installation, you should use silicone sealant to seal off the SecureFlex mount's foot against the wall. For additional information on this topic, see section 2.14, *Mounting the Camera to Different Surfaces*.

The SecureFlex mount covers and protects an RJ45 wall outlet

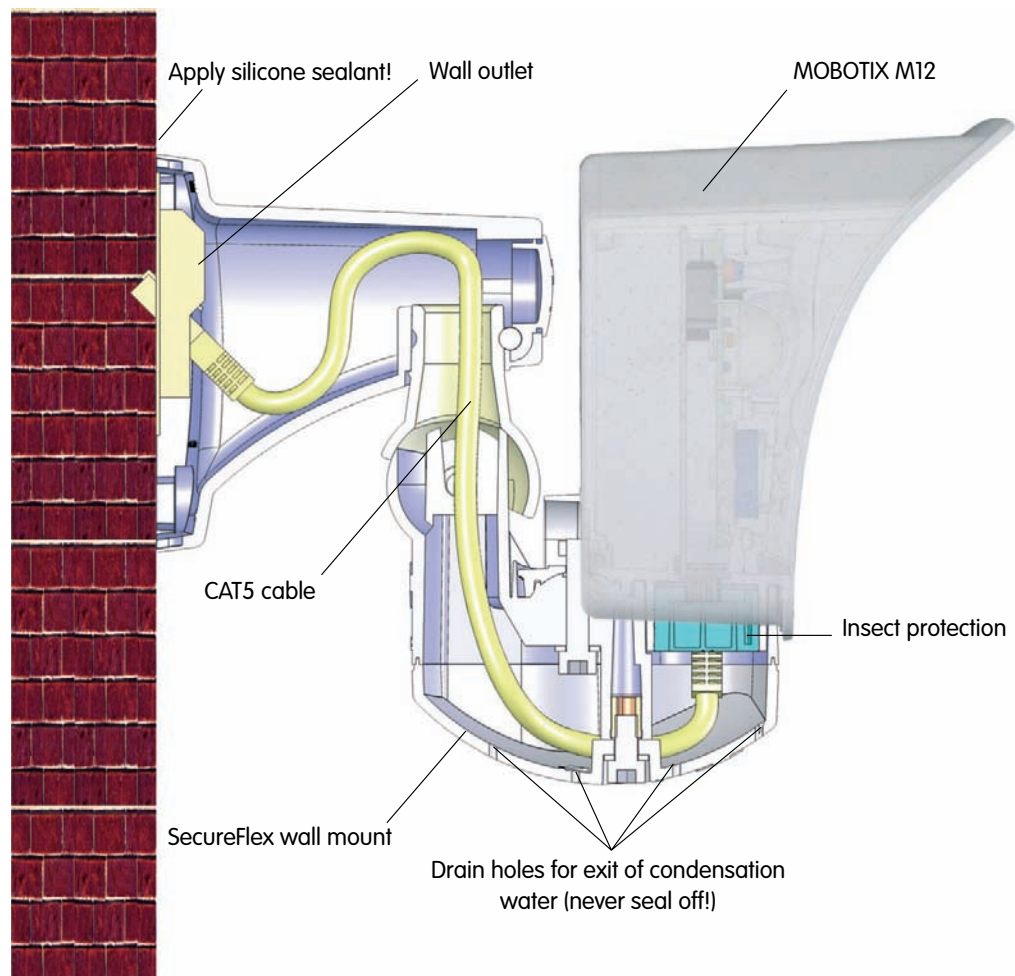

2.8 MOBOTIX M12 Lens Options



MOBOTIX currently offers five different lenses with M14 thread from **Super Wide Angle** (L22) with 22 mm to **Tele** (L135) with 135 mm focal length (equiv. to 35mm camera). Since MOBOTIX cameras are backlight-proof, these lenses do not require an auto iris. Without the iris as a mechanical component, these glass lenses are extremely robust and maintenance-free.

You can choose between the following lenses for the MOBOTIX M12: **L22 Super Wide Angle 90°**, **L43 wide-angle** and **L135 Tele**. The **L22 Super Wide-Angle 90°** has very little distortion, even when using the 4x digital zoom of the M12. Mounting a camera with the Super Wide Angle lens in the corner of a room will allow you to see the complete room (see figure right).



L22 Super Wide Angle 90°

The lenses are installed, focused and sealed at the factory to prevent the lenses from losing focus (e.g. from vibrations). The **L135 Tele** lens is an exception as it is focused using the supplied adjustment ring (see section 2.16, Adjusting the *Tele Lens Focus*).

	L22 Super Wide Angle 90°	L32 Wide Angle*	L43 Wide Angle	L65 Tele*	L135 Tele
MOBOTIX Lenses					
	approx. 90°H x 67°V at 10 m appr.: 20.0 x 13.3 m	approx. 60°H x 45°V at 10 m appr.: 11.5 x 8.2 m	approx. 45°H x 34°V at 10 m appr.: 8.2 x 6.1 m	approx. 31°H x 23°V at 10 m appr.: 5.5 x 4.0 m	approx. 15°H x 11°V at 10 m appr.: 2.6 x 1.9 m

* not available for M12 models

Focal lengths of MOBOTIX lenses are always given as compared to a 35 mm camera!





To determine the lens you need, simply use a camera with zoom lens to find a matching MOBOTIX lens

Note

The focal lengths of MOBOTIX lenses do not reflect the actual focal length of the lenses, but the focal length (L_{xx} mm) converted to 35 mm camera format. For example, the MOBOTIX Super Wide-Angle lens has an actual focal length of 4 mm. This would be the equivalent of 22 mm on a 35 mm camera and thus leads to the designation $L22$ for the lens.

Since the image sensors in digital cameras have different sizes, converting to 35 mm camera format provides for better comparing the image format and field of vision parameters of different lenses. Another benefit is that you can easily set a 35 mm camera (analog or digital) to the same focal length (L_{xx}) to obtain the same field of vision. This approach greatly facilitates lens selection.

Lens Table

Order name	L22	L32*	L43	L65*	L135
Original image					
Equiv. 35 mm camera	22 mm	32 mm	43 mm	65 mm	135 mm
Focal length	4 mm	6 mm	8 mm	12 mm	25 mm
F-Number	2,0	2,0	2,0	2,0	2,5
Image angle horizontally	90°	60°	45°	31°	15°
Image angle vertically	67°	45°	34°	23°	11°
Installed at 1 m	m	m	m	m	m
• Image width	2,0	1,1	0,8	0,5	0,3
• Image height	1,3	0,8	0,6	0,4	0,2
Installed at 5 m	m	m	m	m	m
• Image width	10,0	5,7	4,1	2,7	1,3
• Image height	6,6	4,1	3,0	2,0	1,0
Installed at 10 m	m	m	m	m	m
• Image width	20,0	11,5	8,2	5,5	2,6
• Image height	13,3	8,2	6,1	4,0	1,9
Installed at 20 m	m	m	m	m	m
• Image width	40,0	23,0	16,4	11,0	5,2
• Image height	26,6	16,4	12,2	8,0	3,8
Installed at 50 m	m	m	m	m	m
• Image width	100,0	57,5	41,0	27,5	13,0
• Image height	66,0	41,0	30,5	20,0	9,5

* not available for M12 models

2.9 The MOBOTIX SecureFlex Mount

The **SecureFlex mount** (item 1) enables easy mounting of the MOBOTIX M12 models to a **wall** or a **ceiling**. Its innovative and flexible design allows positioning the camera into virtually any direction. On top, the SecureFlex wall mount covers RJ45 wall outlets (without the frame) and the **concealed cabling** improves the security of the camera. The SecureFlex mount is **pre-installed on all MOBOTIX M12 models**.

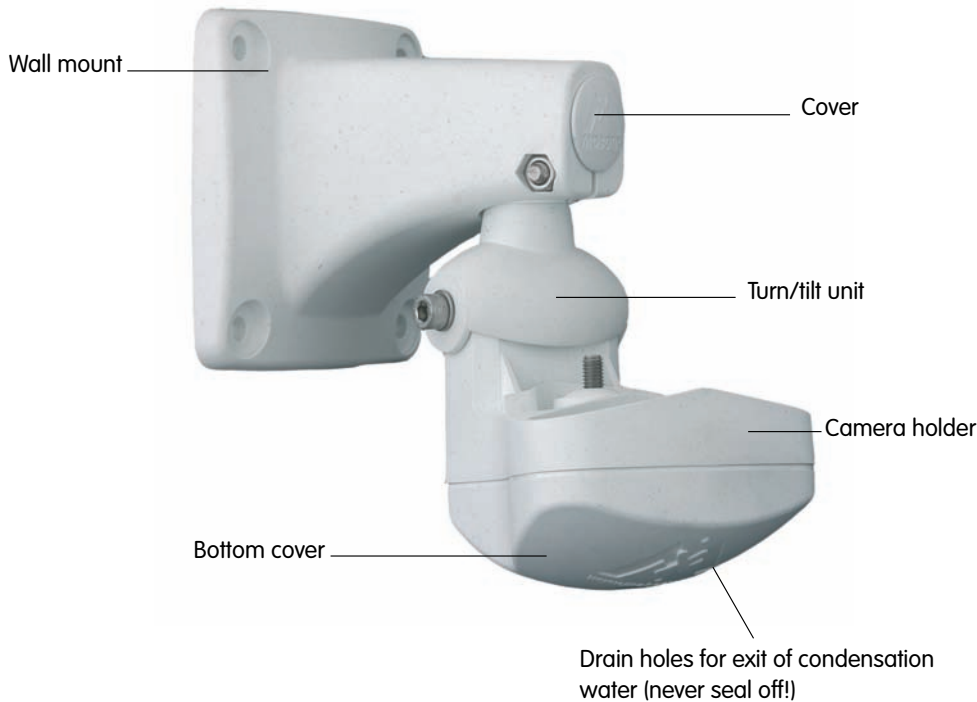

Note

Since the external power supply cannot be connected to the **ISDN** connector of the camera, it is recommended to use a **Network Power Adapter**, a **Network Power Rack** or a **standard PoE switch or router** to inject power into the Ethernet cabling. As an alternative, a suitable extension cable may also work.



MOBOTIX Network Power Adapter or Network Power Box/Rack or PoE-compatible switch/router should be used

Caution

The SecureFlex mount must not be installed upside-down, as the camera will not be dustproof and resistant against water jets (IP65) any more! The holes in the bottom cover always have to point downwards.

2.10 Dimensions (Ceiling Mount/Wall Mount)

2.10.1 Dimensions—Ceiling Mount

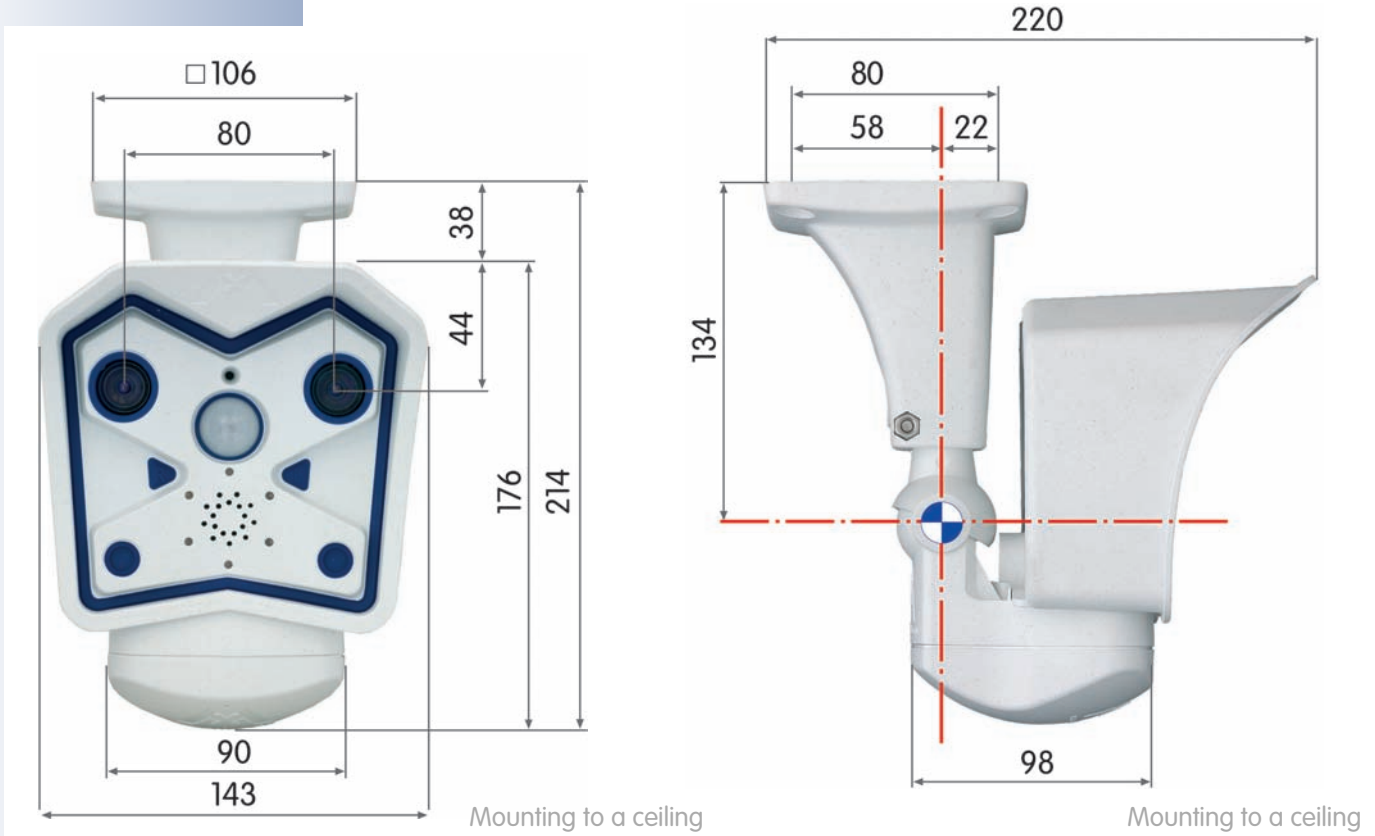

2.10.2 Dimensions—Wall Mount

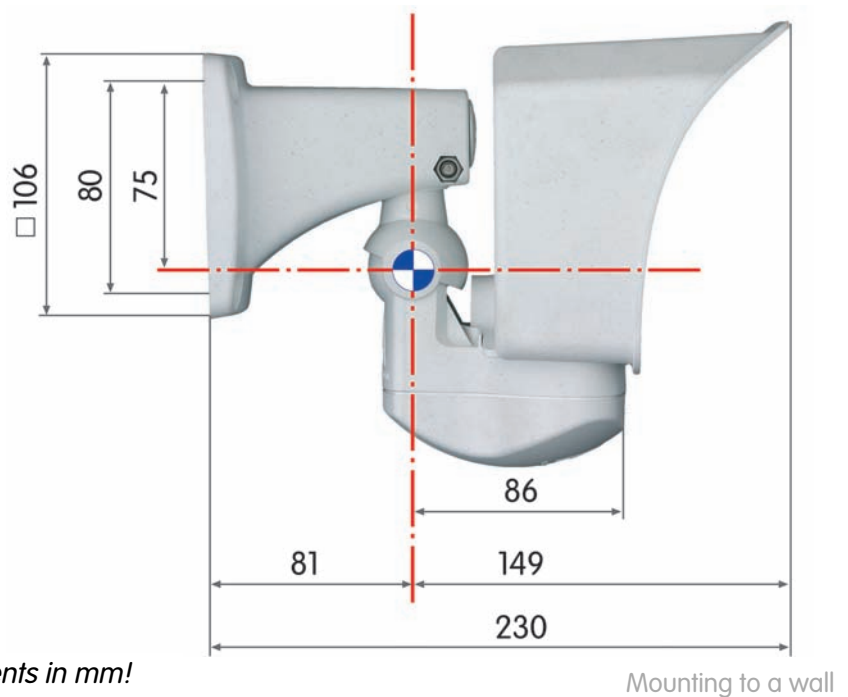

All measurements in mm!

2.10.3 Dimensions of the SecureFlex Mount's Foot

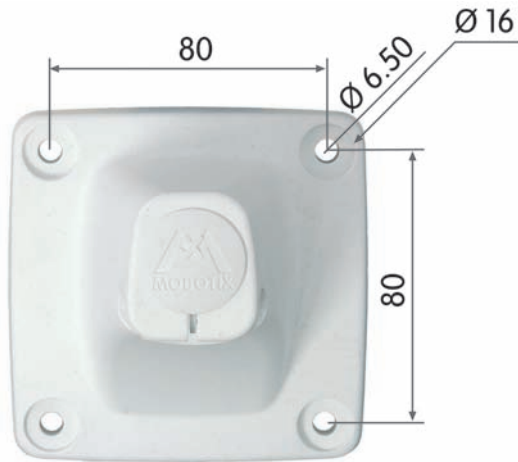

Available Space Within Foot

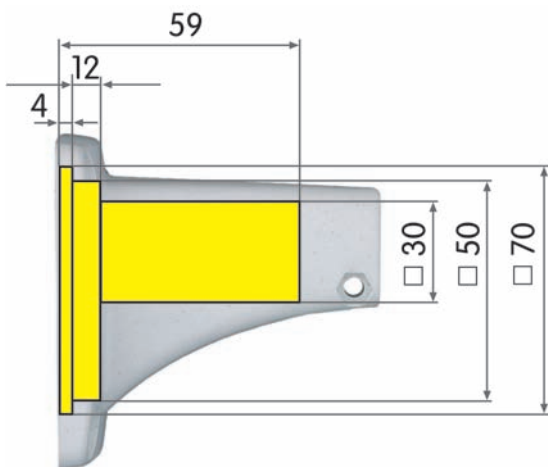

All measurements in mm!

Max. torque for all Allen screws: 4 Nm (2.95 lbf ft)

Note

Check the appendix for the drilling template, which will be helpful when drilling the holes. For more detailed information on planning, please download the **MOBOTIX Planning Aid** from www.mobotix.com.



The mount covers RJ45 wall outlets and completely conceals the cabling

When **mounted to a wall**, the camera can be **turned/tilted** as follows:

- horizontally: approx. 180°
- vertically: approx. 70°

When **mounted to a ceiling**, the camera can be **turned/tilted** as follows:

- horizontally: approx. 360°
- vertically: approx. 90°

2.11 Mounting the MOBOTIX M12 to a Wall or Ceiling

Caution

Never use screws with countersunk heads to fasten the mount, as these screws will destroy the mount.

The foot of the SecureFlex mount is large enough to **completely cover a wall outlet** (see section 2.12, *Preparing the Installation*).

2.11.1 Mounting to a Wall

Before attempting to mount the camera, make sure that you have found the best camera position. It is important that the camera's field of view is not obstructed in any way.

Once the camera has been mounted to the wall, you can fine-tune its position. Using the SecureFlex mount, the camera can be tilted horizontally and vertically.

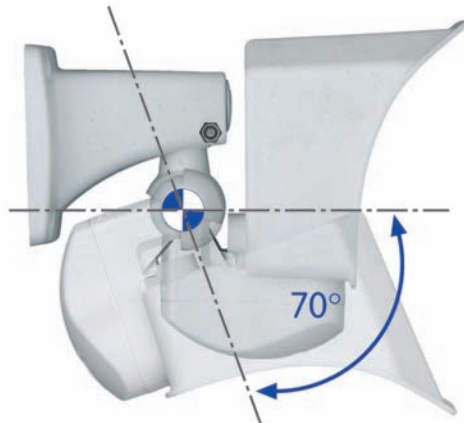

2.11.2 Mounting to a Ceiling

Before attempting to mount the camera to a ceiling, make sure that you have found the best camera position. It is important that the camera's field of view is not obstructed in any way.

Once the camera has been mounted to the ceiling, you can fine-tune its position. Using the SecureFlex mount, the camera can be tilted horizontally and vertically.



2.11.3 Converting the Wall Mount to Ceiling Mount

If the camera is to be mounted to a ceiling, the SecureFlex mount can be converted in four easy steps. Proceed as outlined in the following:

- (1) Unscrew the **upper Allen screw** in the foot of the mount, which holds the turn/tilt unit in place (5 mm Allen wrench, item 3). Remove the Allen screw, the washer and the hex nut from the mount and unplug the **cover**.
- (2) Gently pull the **turn/tilt unit** and all cables out of the vertical opening of the foot.
- (3) First insert the **cables**, then the turn/tilt unit into the horizontal opening of the foot (all the way to the stop).
- (4) Place the hex nut into the corresponding hole, insert the **Allen screw** with washer and lightly fasten the screw so that you can still easily move the camera.

Converting the ceiling mount back to wall mount follows the steps in reverse order. Only insert the supplied **cover** into the remaining opening once you have finished mounting the camera.

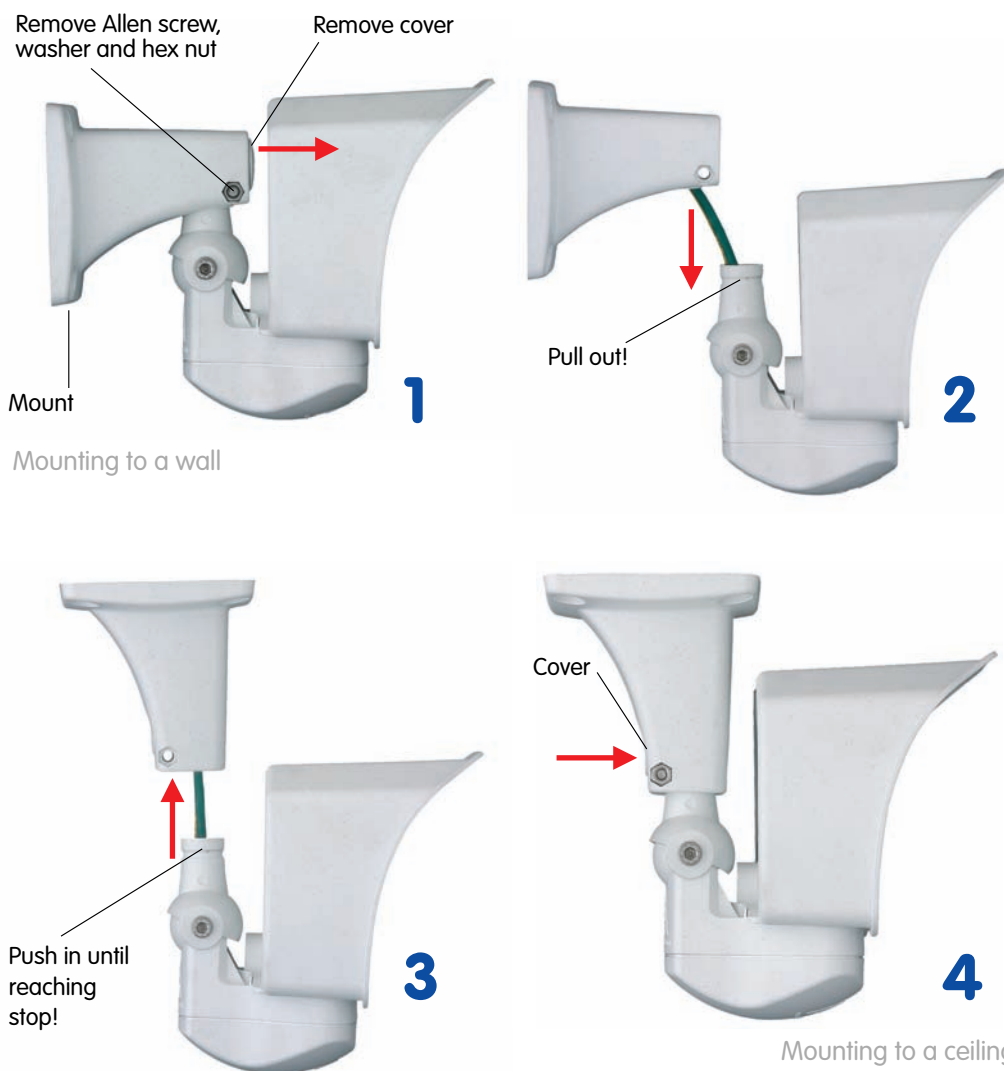

Converting from wall mount to ceiling mount in four easy steps

Max. torque for all Allen screws: 4 Nm (2.95 lbf ft)

The SecureFlex mount should completely cover the wall outlet



Insect protection (installed)

Simply connected to the network

2.12 Preparing the Installation

Mounting the SecureFlex mount to a wall allows **covering RJ45 wall outlets (without cover)** and also allows using a defined network end point.

When positioning the wall outlet, make sure that the outlet lines up with the upper rim of the mount later on (see figure below). If no wall outlet is present, use a suitable extension or an adapter to connect the camera to the network.

When installing an **above-the-wall assembly, breaking out one of the four openings in the mount's foot with suitable pliers** will provide for properly guiding the cable into the mount. When mounting the camera in outdoor scenarios, you should break out the opening that is pointing downwards. For additional information on this topic, see section 2.14, *Mounting the Camera to Different Surfaces*.



2.12.1 Insect Protection of the Camera

MOBOTIX cameras feature a pre-installed **insect protection** (item 8), which effectively prevents small animals from entering the camera. Make sure that the **condensation drain holes** remain open. These openings contain semi-permeable plugs, which allow condensation to exit the camera housing, but also prevent small animals from entering the camera.

Never push any objects into the drain holes as this may damage the plugs!

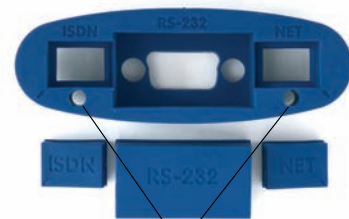

Drain holes with membranes for exit of condensation water

2.12.2 Connecting to the Network (Ethernet)

In order to connect to an Ethernet network, simply attach the pre-installed network cable into the wall outlet or the **extension**. Continue by mounting the wall mount at the camera location, as described in section 2.12, *Preparing the Installation*.

Never insert the pre-installed cable into an ISDN wall outlet! In order to **attach to an ISDN network**, see section 2.12.3, *Connecting Another Cable (ISDN/RS232)* on how to install an additional cable for ISDN connections.



2.12.3 Connecting Another Cable (ISDN/RS232)

In order to connect another cable besides the Ethernet cable (ISDN/RS232), it is necessary to open the bottom cover of the SecureFlex wall mount and to install the additional cables:

- Unscrew the Allen screw of the **bottom cover** using the supplied 5 mm Allen wrench (item 3) and remove the bottom cover, including the Allen screw and the washer.
- Guide the additional cable from below through the camera holder, the turn/tilt unit and the foot to the back of the foot (depending on the position of the wall/ceiling mount, it may help to remove the cover; see also section 2.11.3, *Converting the Wall Mount to Ceiling Mount*).
- Remove the corresponding rubber plug and push the cable into the connector of the camera.
- Reseat the bottom cover and fasten the Allen screw and the washer.
- **Mark the cable connector on the other end** to prevent confusion about the cable's position in the camera.



Easy installation of additional cables (e.g. ISDN/RS232/MX Interface Connector cable)

2.12.4 Inserting an SD Card (Optional)

The MOBOTIX M12 can use an SD card for storing events (available in future versions, after updating the software).

- Remove the bottom cover of the SecureFlex mount.
- Remove the cables (ISDN/Ethernet/power supply).
- Remove the insect protection.
- Insert the SD card until you feel a stop (see figure).
- After inserting the SD card, re-insert the insect protection and the cables and re-install the bottom cover of the SecureFlex mount.

To **remove the SD card**, gently press the card into the camera casing. The card pops out, allowing you to pull it out of the camera.

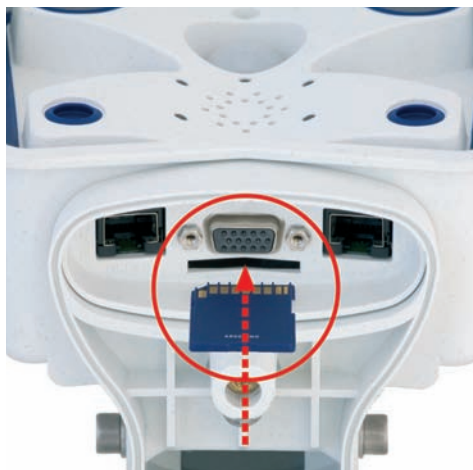

SD cards will be supported after installing a software update (supported in future versions)

2.13 Mounting the Camera

- Copy or print the **drilling template** for the SecureFlex mount at the back of the manual (make sure *not to scale* the template).
- Mark the holes; when using a **wall outlet**, make sure that the outlet lines up with the upper rim of the mount so that the cable is not bent too sharply later on.
- Drill the **holes** and insert the supplied dowels (this is usually not necessary for a wooden wall or structure that is thick enough). Make sure to follow the instructions in section 2.14, *Mounting the Camera to Different Surfaces*.
- Connect the **cables** (see section 2.12, *Preparing the Installation*).
- Properly fasten the SecureFlex mount using the supplied screws and the appropriate washers to the wall. Make sure to follow the instructions in section 2.14, *Mounting the Camera to Different Surfaces*.
- Establish a **connection** from your computer to the camera (see chapter 3, *Operating the Camera*) and adjust the camera position according to the **live image** delivered by the camera.
- Properly tighten the screws of the mount itself and make sure that all screws are properly fastened, then press the supplied caps onto the heads of the hex screws.



Max. torque for all Allen screws: 4 Nm (2.95 lbf ft)

Find the folded **drilling template** at the end of the manual!

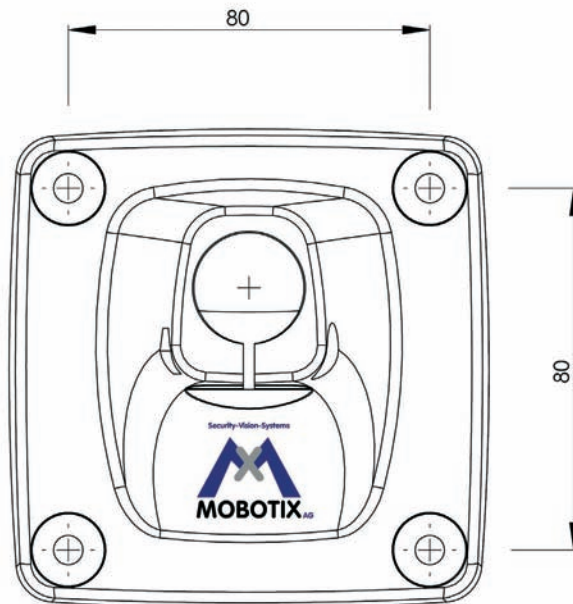

All measurements in mm!



Caution

Never use screws with countersunk heads to fasten the mount, as these screws will destroy the mount.

2.14 Mounting the Camera to Different Surfaces

Note

Above-the-wall assembly:

When installing an **above-the-wall assembly** instead of using a wall outlet, you can break out one of the four cable openings in the base of the mount to properly guide the cable into the mount.

Mounting the camera outdoors:

When using a **wall outlet for an outdoors installation**, you should use silicone sealant to prevent water from entering the wall outlet and the cabling by sealing off the mount's base against the wall. You should break out the lower cable opening in the mount's base to prevent condensation from accumulating. Make sure not to seal off this opening.

When using an **above-the-wall assembly**, make sure that you install the cable from the bottom-most cable opening in order to prevent rainwater from entering the mount. When using an **above-the-wall assembly**, sealing off the SecureFlex mount and the wall is not absolutely necessary. Make sure that condensation can exit the mount despite the above-the-wall assembly. Make sure not to seal off this opening.

Wall thickness:

Make sure that the wall is at least five centimeters (2") thick if you intend to use the supplied dowels and screws.



2.14.1 Mounting to a Wooden Wall or Surface

Use the supplied materials and suitable tools for mounting the SecureFlex mount to a wooden wall or surface. Follow the *Mounting Instructions* below to complete the installation.

Use the supplied wood screws without dowels, if you are mounting the camera to a thick wooden wall or structure. If the wooden wall or surface is too thin or if concrete or brick is behind the wood, you should also use the supplied dowels for mounting. Make sure that you know how thick the wooden wall or surface is, before you start drilling the holes. Please also follow the instructions in the following sections.



Required Materials:

- 4 hex head screws (Pos. 6)
- 4 washers (Pos. 5)

Required Tools:

- Wrench or ratchet for M6 hex heads
- Allen wrench 5 mm (item 3)
- Possibly power drill and drill bit for pre-drilling

Mounting Instructions:

- Slide a washer (item 5) over every hex head screw (item 6).
- Press the SecureFlex mount against the wooden wall or surface.
- Insert the four screws (with washers) into the openings in the foot of the SecureFlex mount.
- Tighten the screws using the wrench or ratchet.
- Check the screws for proper tightness and push the caps onto the hex heads.

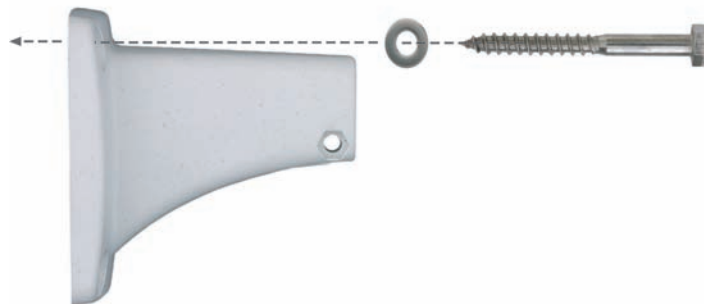

2.14.2 Mounting to a Drywall

Use the supplied materials and suitable tools for mounting the SecureFlex mount to a drywall. Follow the *Mounting Instructions* below to complete the installation.

Required Materials:

- 4 hex head screws (Pos. 6)
- 4 washers (Pos. 5)
- 4 dowels (Pos. 4)



Required Tools:

- Power drill
- Suitable drill bit
- Hammer (optional)
- Wrench or ratchet for M6 hex heads
- Allen wrench 5 mm (item 3)

Mounting Instructions:

- Hold the drilling template at the position where you would like to mount the camera.
- Mark the holes for drilling with a pencil or a sharp object, then remove the drilling template.
- Drill the holes with the power drill where you just marked.
- Insert a dowel into each of the holes you just drilled. If required, use the hammer to press the dowels into the holes.
- Slide a washer (item 5) over every hex head screw (item 6).
- Hold the SecureFlex mount against the wall. Make sure that the openings in the mount's foot line up with the dowels.
- Insert the four screws (with washers) into the openings in the foot of the SecureFlex mount and into the dowels.
- Tighten the screws using the wrench or ratchet.
- Check the screws for proper tightness and push the caps onto the hex heads.

Find the drilling template at the end of the manual

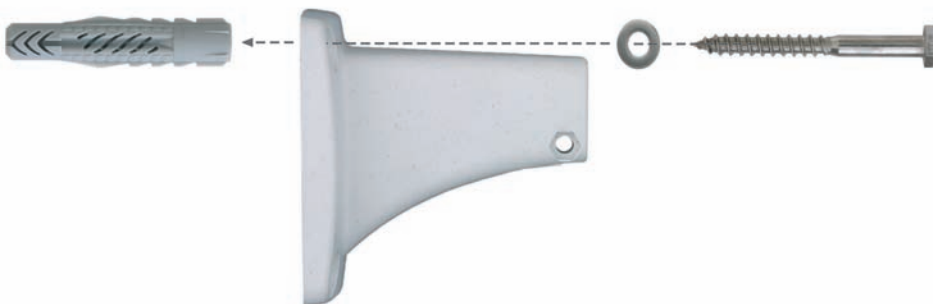

2.14.3 Mounting to a Concrete or Brick Wall

Use the supplied materials and suitable tools for mounting the SecureFlex mount to a concrete or brick wall. Follow the *Mounting Instructions* below to complete the installation.

Required Materials:

- 4 hex head screws (Pos. 6)
- 4 washers (Pos. 5)
- 4 dowels (Pos. 4)



Required Tools:

- Power drill
- Suitable drill bit
- Wrench or ratchet for M6 hex heads
- Hammer (optional)
- Allen wrench 5 mm (item 3)

Mounting Instructions:

- Hold the drilling template at the position where you would like to mount the camera.
- Mark the holes for drilling with a pencil or a sharp object, then remove the drilling template.
- Drill the holes with the power drill where you just marked.
- Insert a dowel into each of the holes you just drilled. If required, use the hammer to press the dowels into the holes.
- Slide a washer (item 5) over every hex head screw (item 6).
- Hold the SecureFlex mount against the wall. Make sure that the openings in the mount's foot line up with the dowels.
- Insert the four screws (with washers) into the openings in the foot of the SecureFlex mount and into the dowels.
- Tighten the screws using the wrench or ratchet.
- Check the screws for proper tightness and push the caps onto the hex heads.

Find the drilling template at the end of the manual

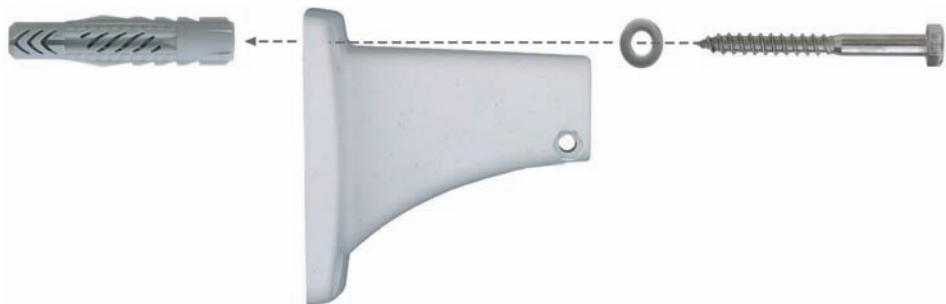

2.14.4 After Mounting the Camera

Controlling the image position and the focus

- Loosen both screws at the turn/tilt joints of the mount using the supplied Allen wrench (item 3) so that you can easily turn and tilt the camera.
- Display the camera images on a computer monitor, then turn and tilt the camera until you have found the best position.
- Tighten the screws at the turn/tilt joints of the SecureFlex mount using the Allen wrench (max. 4 Nm/2.95 lbf ft) to make sure that the position of the camera remains as set.
- If required, clean the lens' surfaces using a clean, lint-free cotton cloth.
- Check the image focus (tele lens L135 only) and the camera position on the computer monitor. Please also see section 2.16, *Adjusting the Tele Lens Focus*.

Max. torque for all Allen
screws: 4 Nm
(2.95 lbf ft)



Robust and maintenance-free: Pole mount made of 3 mm stainless steel

2.15 Installing the MOBOTIX SecureFlex Pole Mount

If you are intending to mount the camera on a pole, you should consider using the **MOBOTIX SecureFlex Pole Mount**. This mount is made of **3 mm powder-coated stainless steel (white)** and has been designed specifically for outdoor use. The supplied stainless steel straps allow fixing the mount to poles with diameters between **60 and 180 mm (2.4" to 7.1")**.

By design, the Pole Mount does *not* allow using a wall outlet for the camera cabling.



2.15.1 Delivered Parts of the SecureFlex Pole Mount

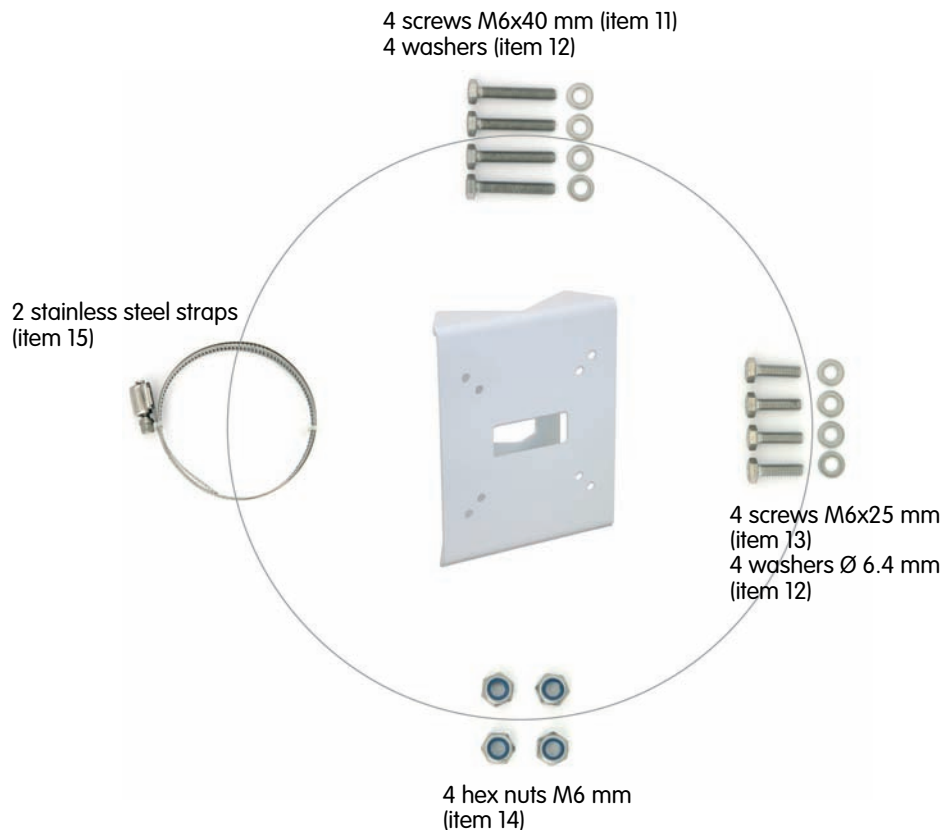

Item	Count	Part Name
11	4	Stainless steel screws M6x40 mm
12	8	Stainless steel washers Ø 6.4 mm
13	4	Stainless steel screws M6x25 mm
14	4	Stainless steel hex nuts M6
15	2	Stainless steel straps

2.15.2 Mounting the Pole Mount and the Camera

Use the supplied stainless steel straps (item 15) for affixing the pole mount to the pole.

- Guide the **connector cables of the camera** from behind through the opening at the center of the pole mount. In order to properly **protect the cabling**, you should let the cabling run from the inside of the pole through the pole mount directly into the camera.

Note: The cable to the camera should be running at least 50 cm (20") outside of the pole!

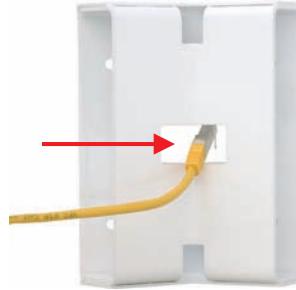

- Guide the stainless **steel straps** (item 15) through the pole mount (see figure). The stainless steel straps allow attaching the mount to **poles with diameters between 60 and 180 mm (2.4" to 7.1")**.

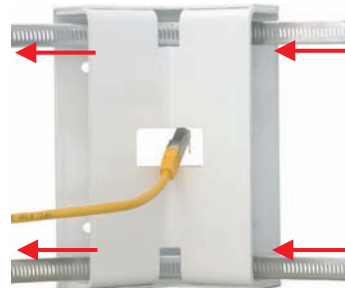

- **Firmly tighten the screws of the stainless steel straps.**



- Unscrew the **upper Allen screw** in the foot of the mount, which holds the turn/tilt unit in place (5 mm Allen wrench, item 3). Remove the Allen screw, washer and hex nut from the mount and pull out the **turn/tilt unit** out of the mount's foot. Remove the **Allen screw** of the **bottom cover** and take off the cover.



- Remove any installed **connection cables** and guide the connection cables through the foot of the mount and the turn/tilt unit of the SecureFlex mount. Hook up the cables to the camera connectors, as described in section 2.12, *Preparing the Installation*.

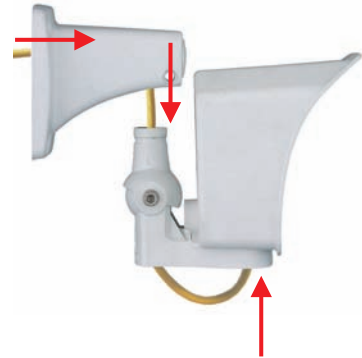

- Re-install the **turn/tilt unit** and the **bottom cover** of the SecureFlex mount and lightly tighten all screws of the turn/tilt unit so you can easily find the best camera position later on.



- Use the supplied **screws M6x25 mm (item 13)**, **washers dia. 6.4 mm (item 12)** and **nuts M6 (item 14)** to attach the pole mount to the pole, then press the white **caps (item 10)** onto the hex heads of the screws.
- Properly position the camera and then tighten all screws of the turn/tilt unit (max. 4 Nm/2.95 lbf ft) to make sure that the camera keeps its position.



Max. torque for all Allen screws: 4 Nm (2.95 lbf ft)

2.16 Adjusting the Tele Lens Focus (Cameras With L135 Tele Lens Only)

Note

How to recognize the 135 mm tele lens: The **135 mm tele lens** has two notches opposite from one another and is not covered by a glass pane. It can be removed using the supplied adjustment ring, which is also used for adjusting the tele lens focus.

Once the camera has been mounted, the tele lens should be checked for proper sharpness and should be adjusted, if required. Make sure that you have the supplied **adjustment ring** ready for this purpose.

- Make sure that you see the camera's live image on a monitor for this purpose.
- Position the adjustment ring on the tele lens. The two prongs fit exactly into the notches of the lens' rim!
- Cautiously turn the lens clockwise until the image is properly focused. **Never turn the lens to far into the lens mount and never apply excessive force when doing so as this would damage the lens mount otherwise.**



Properly adjust the image focus of the 135 mm tele lens. Adjusting the Sharpness software parameter cannot replace this step!



The 135 mm tele lens is focused using the supplied adjustment ring

Note

Use the **focusing aid** of the MOBOTIX camera to properly adjust the lens' focus (see Section 4.3.3, *Image and Audio Settings, Quick Controls* in the *Software Manual*).

3 OPERATING THE CAMERA

3.1 General Procedure

The MOBOTIX camera **does not require any software installation**; all you need is your preferred browser with JavaScript support to operate the camera. Thus, the MOBOTIX camera is supported by all common operating systems (such as **Windows, Macintosh and Linux, ...**).

3.1.1 Establishing the Power Supply of the Camera

You can choose between the following options:

- **External power supply and Network Power Adapter (MX-NPA-3-RJ):** Power supply of one camera injected into the network cabling (max. length 100 m/110 yd.), from the NPA to the **10BaseT/NET** connector of the camera (see section 2.3, *Optional Accessories*).
- **Network Power Box/Rack (MX-NPR-4, or 8/20):** Power supply of 4/8/20 cameras injected into the network cabling (max. length 100 m/110 yd), from the NPR to the **10BaseT/NET** connector of the camera (see section 3.3).
- **Power over Ethernet:** Power supply using network components that are conforming to the PoE standard **IEEE 802.3af**.

3.1.2 Connecting the Camera

The camera has been set at the factory to support the following connection methods:

- **Ethernet interface of the camera** (10/100 Mbps Ethernet): Connect directly from a computer (using a crossover cable) or by using a Network Power Adapter or a switch and a regular patch cable. Launch a browser and enter the IP address printed on the camera label (e.g. **10.1.0.99**).
If the computer does not have an IP address in the **10.x.x.x** network range, you should install **MxControlCenter** for Windows (see section 3.4.7), since the remaining process of connecting to the camera is based on Zeroconf/Bonjour. If this is not possible, you will need to briefly set the computer to the IP address range of the camera (see section 3.4.1).
- **ISDN interface of the camera:** From a computer with ISDN card using a RAS connection (**linux/tux**). Launch a browser and enter the IP address printed on the camera label (e.g. **10.1.0.99**).

Once a connection has been established, click on the **Admin Menu** button to start configuring the camera. The **Admin Menu** controls all network settings (IP address, netmask, DHCP, etc.), ISDN behavior and all other options.

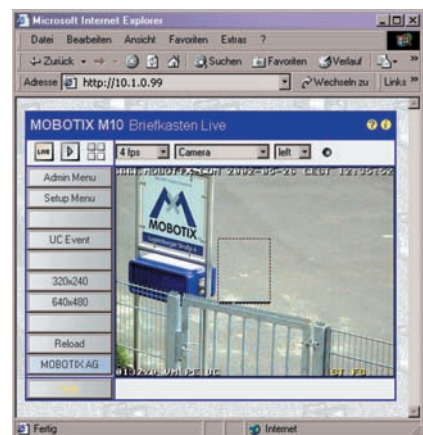

MOBOTIX PoE products do not have any fans and are robust and reliable!

PoE components (IEEE 802.af) should not have fans as this will increase the overall reliability of the entire system

Computer settings:

- IP address: 10.1.0.11
- Netmask: 255.0.0.0
- Gateway: none
- DNS: none

In the RAS box (computer):

- camera phone number
- User: **linux**
- Password: **tux**

Note

After first booting the new MOBOTIX camera or after resetting to factory defaults, accessing the Administration menu (**Admin Menu** button) will automatically start the **Quick Installation** wizard. This is where you configure the most important camera parameters in a step-by-step manner. If you have completed the Quick Installation wizard at least once, the standard Administration menu will open when you click on the **Admin Menu** button.

Always use Quick Installation for initial configuration

The configuration follows these five general steps:

- a) Establish the first connection (Ethernet or ISDN).
- b) Set the parameters for the desired connection type (Ethernet/ISDN) using the **Quick Installation**.
- c) Set the event control (events, actions and messages); see chapter 7, *Events, Actions and Messages*, in the *Software Manual*.
- d) Set the storage parameters (FTP, internal and external ring buffer storage).
- e) Store the configuration in the camera's permanent storage (flash).



Live image: <http://preparkcam.mobotixserver.de>

Always use Quick Installation for initial configuration

Admin Menu

User: **admin**
Password: **meinsm**

Setup Menu

Recommendation:
Always use factory image settings!

3.2 Overview of the Configuration Settings

Using the Quick Installation wizard

After first booting the camera or after resetting it to factory defaults, any access to the administration menu (**Admin Menu** button) will start the **Quick Installation**.

This wizard will guide you through the most important settings of the camera (configuration of the network interface, image control, etc.) and can also be used to reset the camera to its factory settings.

It is also recommended to use **Admin Menu > Quick Installation** later on as well, e.g. if you would like to change connection parameters or add a new connection type.

Administration and setup of the camera

Basic configuration tasks of the camera (e.g. passwords, interfaces, software updates) are carried out from the administration menu (**Admin Menu** button) which requires the corresponding access rights (*admins* group).

Open the **Setup Menu** (button) and find the dialogs for changing the image, event and recording settings in the **Image Control** and **Event Control** sections. These options are also available for users belonging to the *users* group.

Some of these settings can be changed using the corresponding pull-down menus above the image on the Live screen.

The image settings are already optimized

The factory image settings of MOBOTIX cameras deliver excellent images for most application scenarios and should not be changed. If you do wish to make changes, your changes should be minor and gradual. If you would like to reset changes without resetting the complete configuration to factory defaults, you can use the **Factory** button at the bottom of the dialog to reset only this dialog's settings. If you would like to reset all image settings, you may do so using the **Manage Settings > Restore Image Settings** pull-down menu above the image on the Live screen.

All changes are temporary

All changes to the configuration are only temporary and can thus be tested easily. Restoring the old configuration settings can be achieved using the **Restore** button in most dialogs or by running **Admin Menu > Restore last stored configuration from flash** (see also section 5.9, *Managing Settings*, in the *Software Manual*).

Once you have finished configuring the camera, you should always **store the settings in the camera's permanent memory**. You can do so in the **Configuration** section of the administration menu (**Admin Menu > Store current configuration into flash memory**) or in each dialog (clicking on **Set** at the bottom of each dialog will temporarily set the changes; clicking on **Close** will ask you to store the complete configuration in the camera's permanent memory).

The **Configuration** section of the administration menu provides more functions for storing, copying and managing camera settings. For additional information on this topic, see chapter 5, *Basic Camera Configuration*, in the *Software Manual*.

A camera that keeps time

Apart from a multitude of possibilities for controlling the camera using time (time tables, holiday and vacation, scheduled tasks, etc.), the camera can also **synchronize its internal clock**. This allows you to keep the camera in synch manually with a computer or fully automatic using a time server. The camera can use NTP time servers or time servers providing Time Protocol (RFC 868). For additional information on this topic, see section 5.4.2, *Date and Time / Time Zones and Time Servers*, in the *Software Manual*.

MOBOTIX cameras can do "More"

In order to provide a better overview, some of the camera dialogs hide less-often used options when showing the dialog. These dialogs have a **More** button in the bottom right corner; click on it to display the advanced options. If all options are displayed, the **Less** button appears. Clicking this button will hide the advanced options.

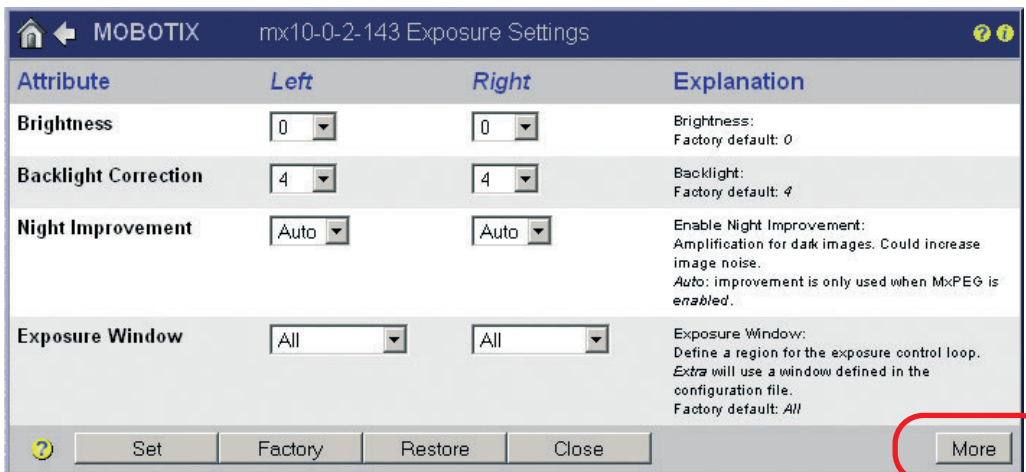

Make sure to permanently store changed parameters!

Automatic time synchronization using a time server

Click on the **More/Less** buttons to show/hide the advanced options

Use the MOBOTIX MX-NPR-4 for smaller installations

Use the 19" MOBOTIX Netpower rack-mount units to supply power to 8 or 20 cameras (MX-NPR-8 or 20)

Uninterruptible power supply (UPS) should be installed

3.3 Connecting the Camera

Notes

The MOBOTIX M12 **can only be powered using the 10BaseT/NET connector of the camera**. In order to inject the power supply into the network cabling, **MOBOTIX PoE products** have proven reliable and easy to install for one camera (**MX-NPA-3-RJ**), for up to four cameras (**MX-NPR-4**) and for 8 or 20 cameras (**MX-NPR-8/20**; see section 2.10, *Optional Accessories*).

It is highly recommended to use uninterruptible power supplies (UPS), which also protect the cameras and the network components against electrical surges. For more information on this topic, read section 2.6.1, *Using Uninterruptible Power Supplies (UPS)*.

Maximum Cable Lengths (Ethernet)

Data/power connection: max. **100 m (110 yards)**

3.3.1 Ethernet: Power Supply Using a Network Power Adapter (MX PoE)

Make sure that you only use switches or routers that support the **10/100 Mbps Ethernet interface** of the camera and check the LED activity of the corresponding port of the switch or router. For additional information on this topic, see section 4.11, *Operating Many Cameras*, in the *Software Manual*.

- (1) Connect the **Camera** connector of the Network Power Adapter to the **10BaseT/NET** connector of the camera.
- 2a) **Connecting to an Ethernet switch or router:**
 - Connect the **LAN/Power** connector of the NPA to an Ethernet connector of the switch/router or the Ethernet wall outlet.
 - Plug the RJ45 connector of the external power unit into the **PC/Power** connector of the Network Power Adapter.

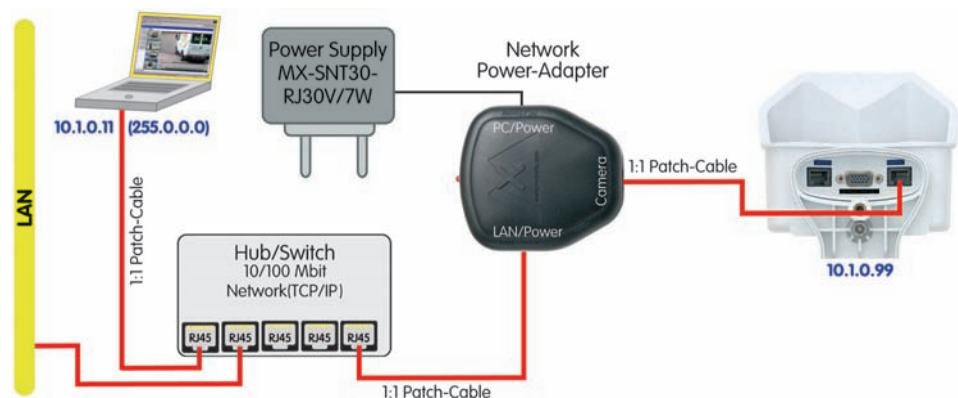

The Network Power Adapter replaces the crossover cable when directly connecting to a computer

2b) **Connecting directly to a computer:**

- Connect the **PC/Power** connector of the Network Power Adapter to the Ethernet port of the computer.
- Plug the RJ45 connector of the external power unit into the **LAN/Power** connector of the NPA.

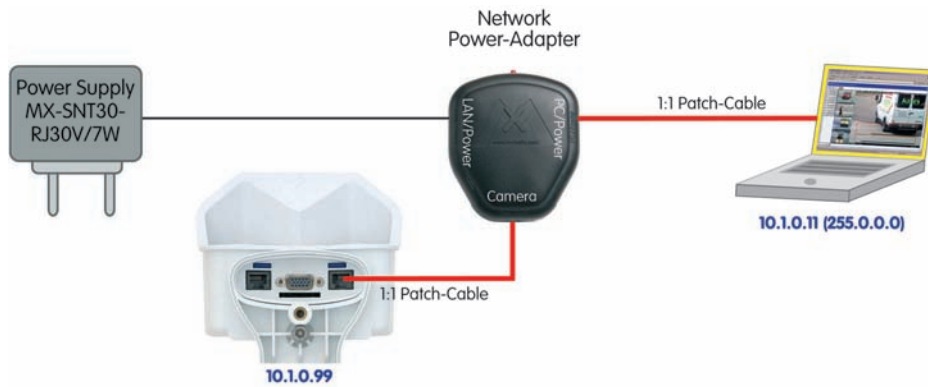

The Network Power Adapter replaces the cross-over cable when directly connecting to a computer

3.3.2 **Ethernet: Power Supply Using a Network Power Rack (MX PoE)**

- Connect the **CAM** connector of the **Network Power Rack (MX-NPR-8/20)** to the **10BaseT/NET** connector of the camera.
- Connect the **LAN** connector of the Network Power Rack to an Ethernet connector of the switch/router.

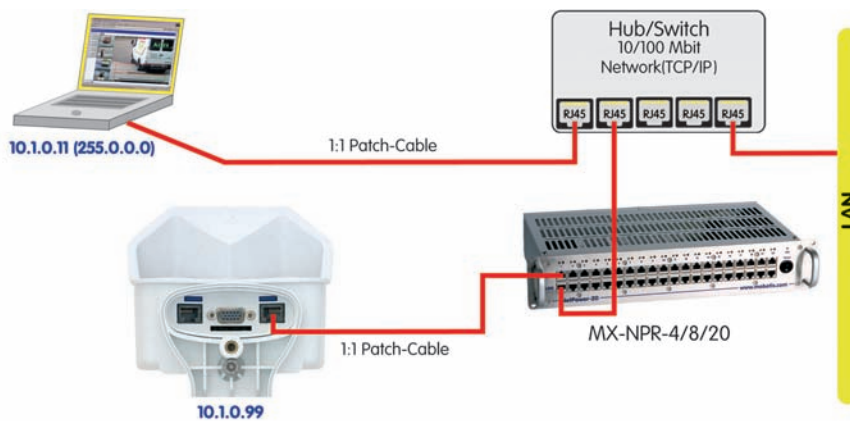

MOBOTIX PoE products have zero maintenance and are reliable as the systems do not require fans

A **Network Power Box (MX-NPR-4)** is connected in the same way.

Advantages of MOBOTIX PoE Products

- Zero maintenance and reliable as the systems do not require fans.
- Higher reliability of the system as a whole, since standard switches without PoE can be used (lower risk of failure).
- Easy installation on DIN rails (*MX-NPR-4*) or in 19" racks (*MX-NPR-8/20*).

3.3.3 Ethernet: Power Supply Using PoE Products (Power over Ethernet)

- Connect the **10BaseT/NET** connector of the camera to the Ethernet connector of the switch/router. The network components need to support the **PoE standard IEEE 802.3af**.

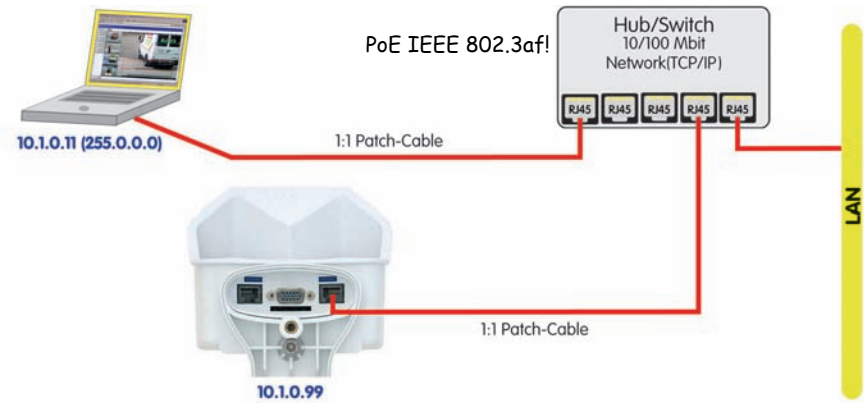

Note

If you are using **IEEE 802.3af Power over Ethernet network components** for supplying power to MOBOTIX cameras, make sure that these components do not have a fan. Since the power consumption of MOBOTIX cameras is very low compared to other products, this increases the reliability of the entire system and expands the life cycle of these components.

PoE components without fans increase overall reliability of the entire system

3.3.4 ISDN: Power Supply Using a Network Power Adapter

- (1) Push the designated connector of the ISDN split cable (*MX-OPT-ISDN-SPLIT*; optional accessory) into the **10BaseT/NET** connector and the remaining cable into the **ISDN** connector of the camera.
- (2) Use an 8-wire (patch) cable to connect the **Camera** connector of the Network Power Adapter to the socket of the **ISDN** split cable.
- (3) Connect the **LAN/Power** connector of the Network Power Adapter to the ISDN S0 bus/NT.
- (4) Plug the RJ45 connector of the external power unit into the **PC/Power** connector of the Network Power Adapter.

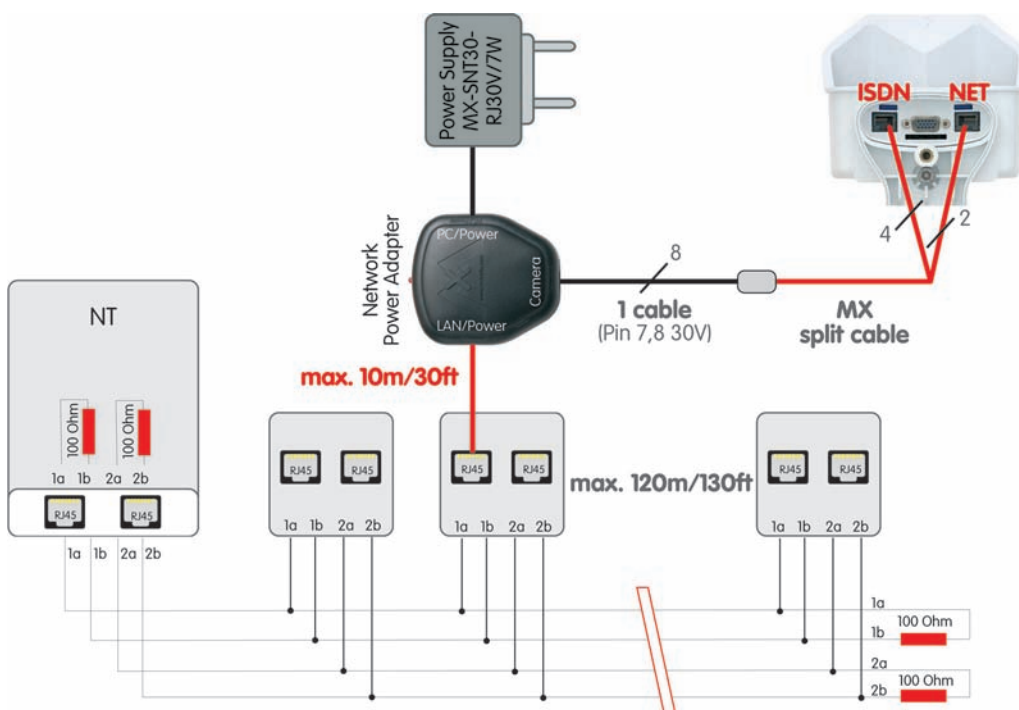

Maximum Cable Lengths (ISDN)

- Connection to **ISDN outlet**: max. **5-10 m (16 to 33 ft.)**
- Connection to **NT (without termination resistors)**: max. **5-10 m (16 to 33 ft)**
- Connection to **NT (with termination resistors)**: **120 m (130 yd)**

Make sure not to exceed the maximum cable lengths

Caution

Missing termination resistors and wrong cable lengths are the most common installation errors!
Always observe the instructions regarding maximum cable lengths and proper ISDN termination!

3.3.7 Camera Startup Sequence

As soon as the camera's power supply has been established, the six LEDs will show the progress of the starting sequence:

- **Hardware test:** After the power has been connected, the LEDs 1 and 5 will light up for about two seconds. The camera's computer (boot loader) checks the camera hardware.
- **Backup system test:** The camera checks the operating system. **In case of an error**, the camera will start using the backup operating system, allowing you to re-install the system software.
- **Unpacking the OS:** The boot loader unpacks the operating system from the Flash EPROM and copies it to the camera's memory (the LEDs 1 and 5 light up for about 10 seconds).
Starting the OS: The Linux operating system unpacks its data to the ramdisk and initializes the system. All operating system components are verified against their checksums in order to detect changes.
- **Boot mode:** As soon as all LEDs light up, you can either start the camera using DHCP ("R" key) or the factory default IP address ("L" key). See sections 3.5, *Starting the Camera With an Automatic IP Address (DHCP)*, and 3.6, *Starting the Camera Using the Factory IP Address*, respectively, for more information.
- **Starting the applications:** Once the application software is running, the LEDs 1 and 5 will start blinking (provided they have not been switched off for this configuration). You can now access the camera using a web browser.



Hardware Test

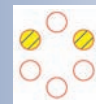

Backup System Test

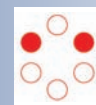

Unpacking/
Starting OS

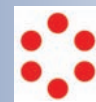

Boot Mode

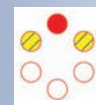

Ready

Note

During the startup sequence, the LEDs will always light up, even if they have been deactivated in **Admin Menu > LED Setup**.



Signals of the camera LEDs:

- 0 On
- 1 Camera
- 2 Ethernet
- 3 Serial interface
- 4 VoIP/ISDN
- 5 Camera

3.4 The First Image from the Camera

In order to establish the first connection to the MOBOTIX camera, choose one of the following options:

- **Ethernet** (10/100 Mbps network):
 - **Automatic camera search and configuration** using **MxControlCenter** (free Windows client for MOBOTIX cameras; section 3.4.8, *The First Image in MxControlCenter*)
 - **Manual configuration** (section 3.4.1, *Preparing the Ethernet Connection*)
- **ISDN** (section 3.4.2, *Preparing the ISDN Connection*)

Besides using **MxControlCenter**, you can also use a **browser** to access the camera (section 3.4.4, *The First Image in the Browser*).

In order to finish the camera configuration, you can use either **MxControlCenter** or the browser-based user interface of the camera (see section 4.3, *The Live Screen in the Browser*, in the *Software Manual*).

3.4.1 Preparing the Ethernet Connection

For this example, we will use a camera with the factory IP address **10.1.0.99**. **Replace this IP address with the IP address of your camera.** You will find this address on a **small sticker on the camera**. Accessing the camera is always the same and is independent of the connection type: simply enter the camera's IP address in the address field of the browser (see section 3.4.4, *The First Image in the Browser*).

Note

Pressing the **"R" key** on the front of the camera will let the camera **announce the current IP address of the camera on the loud-speaker.**

Your computer has to have a network or a wireless interface, and it should be in the same subnet as the camera. If your network also uses IP addresses of a class A network (e.g. **10.x.x.x**, network mask **255.0.0.0**), you should be able to access the camera directly (provided no other network device uses the same IP address).

Determine the IP address of your computer:

- Open a command shell (Windows) or a terminal (Linux/UNIX/OS X) and enter the following command:

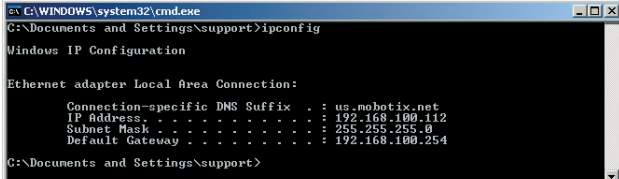

```

C:\WINDOWS\system32\cmd.exe
C:\Documents and Settings\support>ipconfig

Windows IP Configuration

Ethernet adapter Local Area Connection:

    Connection-specific DNS Suffix  . : us.mobotix.net
    IP Address . . . . . : 192.168.100.112
    Subnet Mask . . . . . : 255.255.255.0
    Default Gateway . . . . . : 192.168.100.254

C:\Documents and Settings\support>
  
```

Windows 2000/XP: **ipconfig**

Linux/UNIX/OS X: **ifconfig**

Automatic camera search and configuration using **MxControlCenter**

Caution:
Netmask 255.0.0.0

Open a Command Prompt (Windows):
Start > Run, enter "cmd", then press [Return]

You will find the IP address of your Windows computer under **IP address**; for Linux/UNIX/OS X computers, search for the **inet address** parameter of the **eth0** device (the first network interface). If your computer does not use an IP address in the 10.x.x.x range, you should change the network configuration of your computer or add a new IP address (see below).

Make sure that no other network device uses the camera's IP address:

- Open a command shell (Windows) or a terminal (Linux/UNIX/OS X) and enter the following command:
ping <factory IP address>

If you receive an answer from another network device although the camera is not connected, you will have to remove that device until you have reset the MOBOTIX camera to a free IP address. We recommend using the Quick Installation wizard for this task.

If your computer does not use an IP address in the 10.0.0.0 network (e.g. a 192.168.x.x or 172.x.x.x network), you should temporarily set a new IP address in the 10.x.x.x range:

Windows 2000/XP

- (1) Open the **Network Connections** and open the **Properties of LAN Connection**.
- (2) Double-click **Internet Protocol (TCP/IP)**.
- (3) On the **General** tab, activate the **Use the following address** option.
- (4) Enter an IP address (e.g. **10.1.0.11**) in the class A network (10.x.x.x) that is unique in your network and that is not the same as the camera's IP address.
- (5) Close all dialogs by clicking on **OK**.

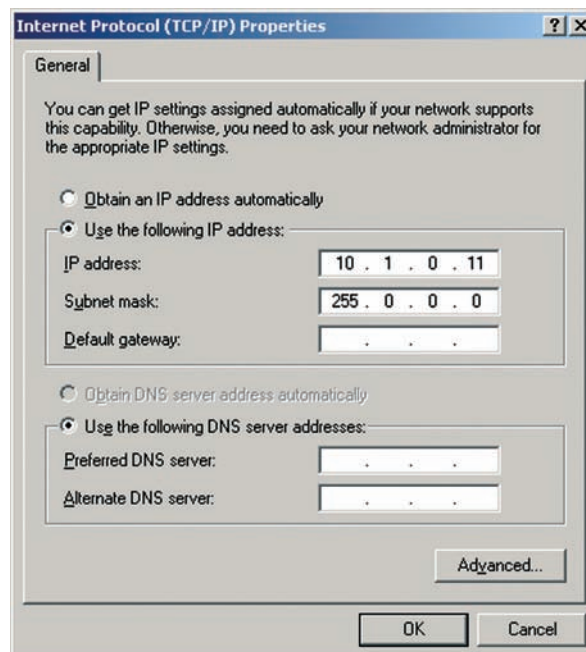

The factory IP address is printed on the sticker on the camera housing

Example: 10.1.0.99

Make sure that you use the IP address of your camera instead of 10.1.0.99!

Setting up an IP address on Windows computers

Linux/UNIX/OS X

- (1) Open a terminal as **root** user and enter the following command (**eth0** usually is the first network interface):
ifconfig eth0:1 10.1.0.11

The computer now has the additional IP address **10.1.0.11**, allowing it to access the camera with its factory IP address in the 10.x.x.x network (**10.1.0.99** in this example).

Setting up a second IP address on Linux/UNIX computers

Requires an ISDN interface card in the PC

Assign different MSNs (phone numbers) to the cameras if they are on the same SO bus

Routing allows reaching different network addresses using different connection types/routes

3.4.2 Preparing the ISDN Connection

Your computer must have a properly configured ISDN card to establish a connection. If your network has an ISDN router, contact your network administrator for more information.

- (1) Create a new Point-to-Point connection (PPP) on your computer.
- (2) Enter **linux** as user name and **tux** as password.
- (3) Enter the phone number (a free MSN) of the ISDN port to which you connected the camera. If your computer is connected to an internal telephone system, make sure that you enter the prefix that is required to obtain an outside line.

The MOBOTIX camera can **automatically determine the MSN** (see section 5.2.2, *Quick Installation Pages in Detail*, in the *Software Manual*).

- (4) Establish the connection.



By factory default, the camera will react to every MSN of an ISDN port (you may change this in **Admin Menu > ISDN Connections**).

Note

Default ISDN access credentials for RAS connections

User Name: **linux**
Password: **tux**

3.4.3 Simultaneously Using ISDN and Ethernet Connections (Gateway)

In most cases, MOBOTIX cameras will be used either on an Ethernet LAN **or** on ISDN, not both. The gateway (for accessing computers outside of the local network) needs to be set manually for Ethernet; it is usually obtained automatically for ISDN.

In order for the camera to open an ISDN dial-out connection while both Ethernet and ISDN are used, the **default route** has to be set to the preferred ISDN dial-out connection (**Admin Menu > ISDN Data Connections > Dial-Out Connections**). Section 5.2, *Quick Installation* in the *Software Manual*, contains more information on this topic.

If you would like to use connections to different networks for other tasks (e.g. backup to an FTP server), you can set more network routes in **Admin Menu > Routing**. See the **Routing** topic in the camera help for more information.

3.4.4 The First Image in the Browser

Now that you have successfully started the camera for the first time, you can access the camera using your preferred browser to see the live video stream and the user interface. Internet Explorer, Mozilla, Firefox, Safari or any other graphical browser with activated JavaScript is suitable. The operating system is of no importance, even PDAs can be used without any problems.

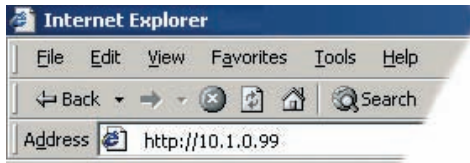

Camera access:
http://10.1.0.99 (example IP)

The factory IP address is printed on the sticker on the camera

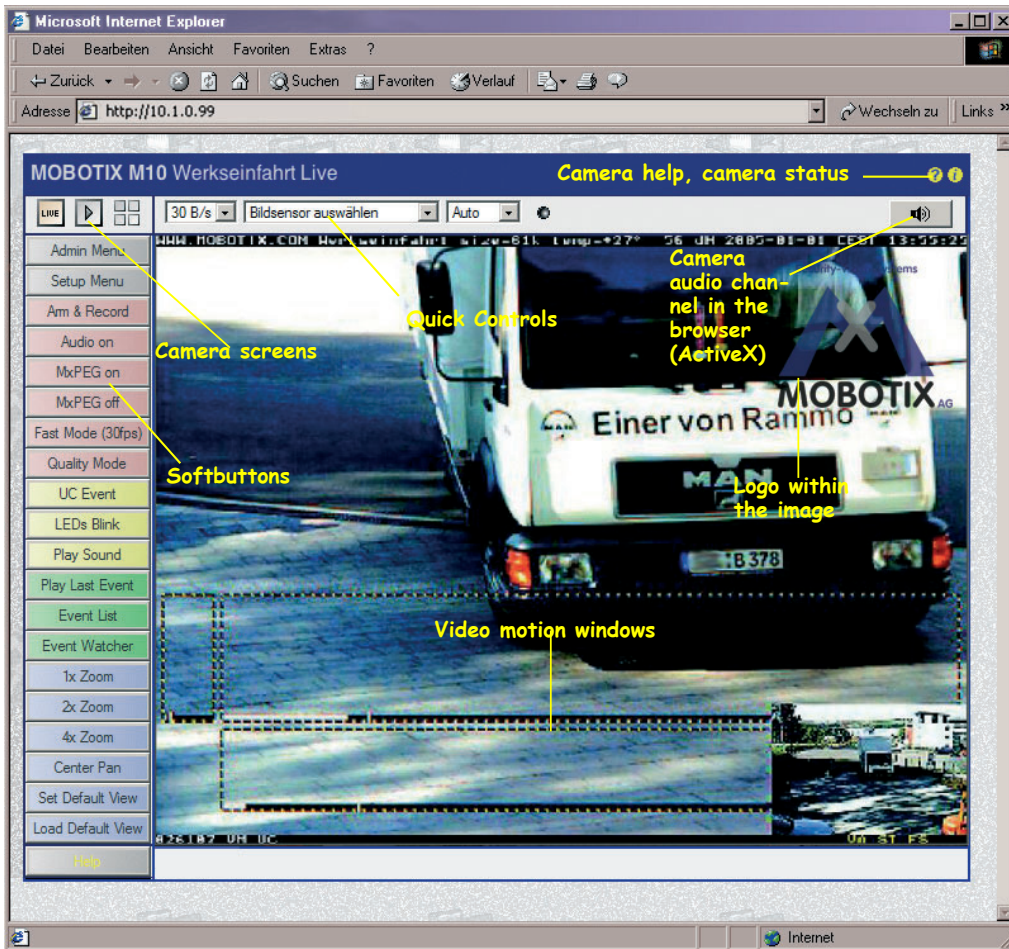

Administration menu:
User Name: **admin**
Password: **meinsm**

Softbuttons are **freely configurable**

After entering the camera's IP address in the browser address bar (e.g. **http://10.1.0.99**), you will see the **Live** screen of the MOBOTIX camera with its user interface controls, such as softbuttons, buttons for the different camera screens, **pull-down menus** (*Quick Controls*), icons for accessing the **online help** and the **camera status**, and status information elements above and below the live image.

Make sure that you use the IP address of your camera instead of 10.1.0.99!

Note	
Credentials for accessing the Administration Menu	
User Name:	admin
Password:	meinsm

Changing the factory IP address: Always use Admin Menu > Quick Installation

Audio announcement of the IP address works on all cameras

Notes

Factory Defaults: Every MOBOTIX camera has its individual factory IP address (e.g. **10.1.0.99**). You will find this address on a small sticker on the camera housing. If you have started the camera using DHCP or you have set the IP address manually, use the new IP address (e.g. **192.168.0.99**) instead of the factory IP address. Pressing the **"R" key** on the back of the camera will prompt the camera to announce its current IP address. For additional information on this topic, see section 3.5, *Starting the Camera With an Automatic IP Address (DHCP)*.

Troubleshooting: If your web browser does not show the camera's **Live** screen after you have entered the IP address, you should try to locate and resolve the error as described in chapter 12, *Troubleshooting*, in the *Software Manual*.

MxControlCenter: In order to see the live image of the camera, you can also use other applications or the integrated programming interface of the MOBOTIX camera. **MxControlCenter** for Windows is such an application and is provided **free of charge** by MOBOTIX. Besides its ability to display fast live video of up to **30 cameras simultaneously at 30 fps each** on one PC, MxControlCenter also allows recording and playing back video clips with realtime audio via the network and can control pan/tilt heads using a joystick or the mouse. Download the newest version of MxControlCenter from the MOBOTIX website. The website contains more information on MOBOTIX systems as well as the MxControlCenter help.

3.4.5 Additional Information

For more information on this topic, see the **News** and **Functional Overview** pages in the online help of the camera's browser interface. Click on the yellow  icon in the top right corner to open the camera's online help.

In order to obtain more information on the camera and its current configuration, open the Camera Status dialog by clicking on the yellow  icon in the top right corner of the camera's browser interface.

Another source of information on all dialogs and parameters of the MOBOTIX camera is the **Reference Manual** that you can download from **www.mobotix.com**. The Reference Manual consists of the MOBOTIX camera's online help in one PDF file.



 Camera Help

 Camera status

3.4.6 Camera Screens in the Browser

Per factory default, the MOBOTIX camera first shows the **Live** screen. You can set a different start page in order to prevent others from changing the settings. In addition to this, you can assign user names and passwords to prevent unauthorized access or you can restrict access to the current live image only by setting the **Guest** screen as the start page.

The following screens are available:

- **Guest** screen: Only shows the current live image with reduced frame rate (see section 4.7, *Guest Screen*, in the *Software Manual*).
-  **Live** screen: Shows the current live image and allows changing the image and event settings of the camera (see section 4.3, *The Live Screen in the Browser*, in the *Software Manual*).
-  **Playback** screen: Shows all recorded images or video clips with extended functions for searching and downloading images, regardless of where the images are stored (in the internal or the external ring buffer on a file server or PC; see section 4.4, *The Playback Screen in the Browser*, in the *Software Manual*).
-  **MultiView** screen: Shows multiple cameras or the last events in a freely definable layout (see section 4.5, *The MultiView Screen in the Browser*, in the *Software Manual*).
- **PDA** screen and **PDA Event List**: Both screens are optimized for PDAs with a focus on fast data transmission with low bandwidth requirements (GSM, GPRS) on devices with small displays (PDAs, mobile phones, sub notebooks). The **PDA Event List** in particular gives a quick overview over the last events since the live image is not transferred (see section 4.6, *The PDA Screen*, in the *Software Manual*).

Note

Use MxControlCenter's **Layout Editor** to design the layout of the camera display on the screen (number of cameras, arrangement, size). The editor supports Drag&Drop, MxPEG clips, and allows using building or property plans and similar graphics as a background image.

For more information on camera screens, see the **online help** of the camera's browser interface. Click on the yellow  icon in the top right corner of the Live screen to open the corresponding page of the online help.



Use the Administration menu to set the camera screen that should appear initially when accessing the camera IP address

<http://10.1.0.99/pda> opens the PDA screen

Live/Playback/MultiView: Click on  to open the online help pages for the camera screens

Automatic network configuration for MOBOTIX cameras using Zeroconf/Bonjour

MOBOTIX cameras support Bonjour by default from software version 3.0.3.37!

3.4.7 Access Using Zeroconf/Bonjour

Zeroconf (short for *Zero Configuration Networking*) describes the networking method of automatically establishing an IP-based network without the help of servers and without changing any settings. Zeroconf-capable devices automatically announce their name and the service they are providing (printer, email server, etc.) in the network. As a basic technology, Zeroconf is part of the current Windows, Linux and Mac OS X operating systems.

Bonjour is the implementation of this service under Apple Mac OS X from version 10.4; in Mac OS X 10.2 and 10.3, this service is called **Rendezvous**.

Bonjour is available free of charge for **Windows** computers from the Apple web site www.apple.com/bonjour.

For **Linux** and **Unix**, **Avahi** provides the corresponding functionality.

For further information on Bonjour and Zeroconf, please consult www.apple.com/macosx/features/bonjour and the Zeroconf web site www.zeroconf.org.

From software version **3.0.3.37**, MOBOTIX cameras automatically offer their web service via Zeroconf/Bonjour. This means that the cameras will announce themselves automatically in a Bonjour list in the web browser and in MxControlCenter. Selecting a MOBOTIX camera in the browser will display the camera's user interface in the browser window; likewise, MxControlCenter will be able to find the camera.



Apple Bonjour

Note

It is the huge **advantage of Zeroconf/Bonjour**, that **you do not need to know the IP address or the name of the MOBOTIX camera in order to access it**.

Another advantage of Bonjour is the fact that **cameras are found regardless if they are in the same subnet as the computer or in other subnets, as long as they are in the same physical network**. If the cameras are not in the same subnet, actually connecting to them is not as easy. The name of the camera is listed in the web browser, but connecting via HTTP will not work, however. Using **MxControlCenter** allows reconfiguring the camera automatically for the subnet of the computer. You can now easily reach the camera in a web browser and MxControlCenter.

Prerequisites for using Zeroconf/Bonjour

MOBOTIX camera:

- Activated **Zeroconf (Admin Menu > Ethernet Interface)**. This is the **factory default** for MOBOTIX cameras from software version 3.0.3.37.
- The camera needs to be in the same subnet as the computer (**Admin Menu > Ethernet Interface**).

Operating system:

- **Microsoft Windows (2000, XP, 2003, Vista):** Bonjour for Windows has to be installed (www.apple.com/bonjour). The application also configures the Windows firewall, installs an add-on for Internet Explorer and the Java Bonjour libraries. The list of Bonjour-enabled network devices is shown in Internet Explorer once the **Bonjour** add-on has been activated in the main toolbar of Internet Explorer.

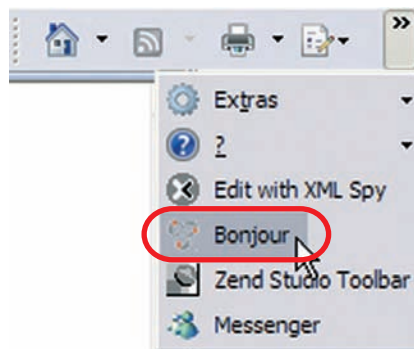

Internet Explorer (Windows): Activate Bonjour add-On

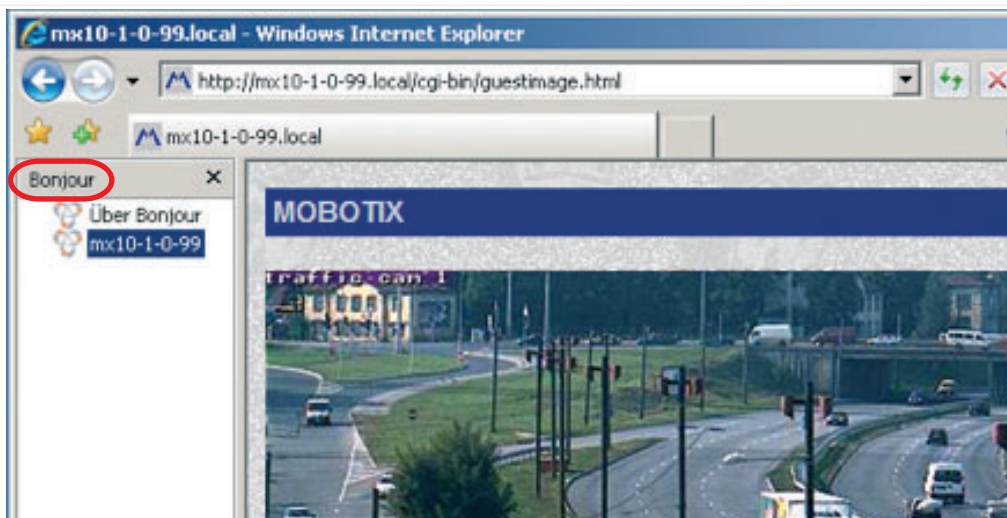

Internet Explorer with activated Bonjour sidebar

- **Macintosh OS X (10.2 or higher):** Bonjour is included in the Apple operating system. There is no other configuration required. The list of Bonjour-enabled network devices is displayed in Safari after clicking on the **Bonjour** button.

Bonjour is enabled by default in Safari (Mac OS X)

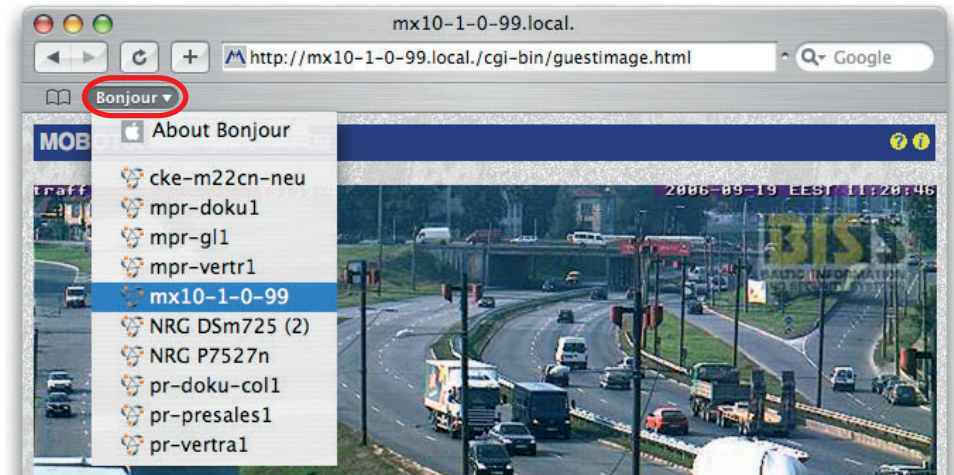

- **Linux:** Zeroconf is included in KDE from version 3.4 and in Gnome from version 2.8. The list of Bonjour-enabled network devices is displayed after entering **zeroconf:/** in the Konqueror address bar. The displayed list contains all Zeroconf-enabled network services (see figure below). Clicking on **/www servers** displays the list of all available MOBOTIX cameras (and all other Bonjour-enabled devices). Linux users can also use the **mdns-scan** application in a terminal to search for Bonjour-enabled devices on the network.

Konqueror on SuSE

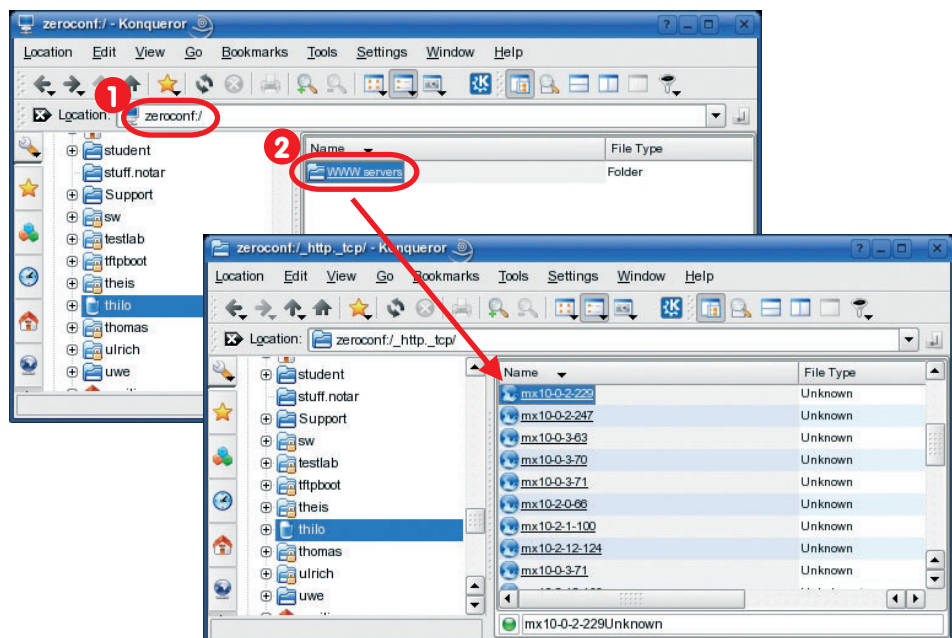

Note

If a **proxy server** is used in your network, you may get an error message when trying to access a MOBOTIX camera in the web browser. Make sure that the list of proxy exceptions in your browser contains the following entry:

- * **.local** (Windows)
- * **.local.** (Mac OS X)
- .local.** (Linux)

To find the **proxy exceptions** in **Internet Explorer** under **Windows**, open **Tools > Connections > LAN Settings > Settings > Proxy server > Advanced** and add the entry in the **Exceptions** text field.

To find the **proxy exceptions** in **Mac OS X**, open **System Preferences > Network > Proxies** and add the entry in the **Bypass proxy settings for these Hosts and Domains** text field.

As an alternative, your network administrator can reconfigure the proxy server so that it does not block **.local** addresses.

Caution: **Proxy servers** may cause errors when trying to establish a connection

Download MxControlCenter free of charge from www.mobotix.com

MxControlCenter Windows client with alarm list, background image and freely positioned cameras

3.4.8 The First Image in MxControlCenter

MOBOTIX MxControlCenter is a free Windows application that allows displaying **multiple MOBOTIX cameras** on one computer and provides alarm management functions. It can easily handle displaying **30 cameras with CIF resolution simultaneously at 30 fps each** in **MxPEG** format on one standard PC with Intel Pentium 4 and 3 GHz.

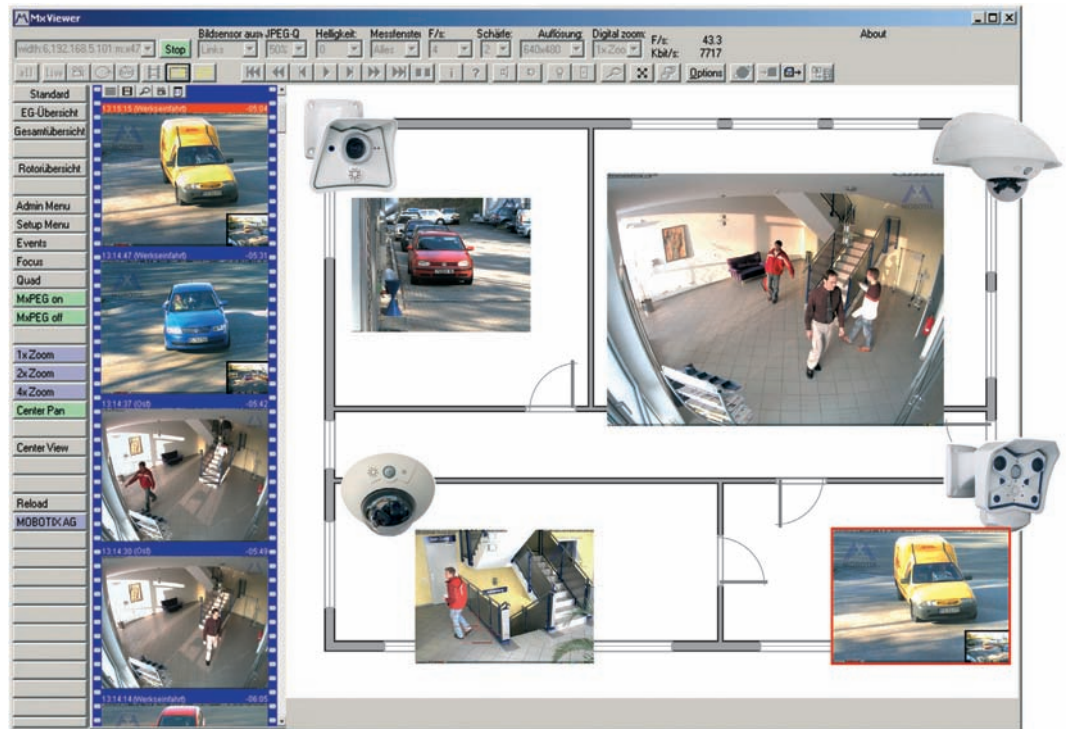

MxControlCenter can do quite a bit more than simply display the video and audio data from MOBOTIX cameras. The unique features of MxControlCenter in combination with the MOBOTIX cameras create a full-featured security system: intelligent alarm handling, various ways of arranging the camera views on different layouts (MultiView screens), ability to display cameras that are sending alarm notifications, the integrated camera management functions, and an array of other interesting features.

Further Information on MxControlCenter

For further information on **MxControlCenter**, download the *MxControlCenter User Manual* from www.mobotix.com:

- Saving and loading MxPEG video clips
- Creating and editing layouts using the Layout Editor

Further Information in the Software Manual

- Section 4.3.5: *JPEG, MxPEG and Audio*
- Section 4.3.6: *Background Information on JPEG, MxPEG and Audio*
- Section 4.10: *Fast Video Streaming*

Installing MxControlCenter

If you have an **MxControlCenter installation CD**, insert it into your computer drive.

If this is not the case or if you would like to update an older version, you can download the latest Windows installer (**MSI** file) from the MOBOTIX website and then manually install the current version. The latest version is available at **www.mobotix.com > Support > Software-Downloads** in the **MxControlCenter** section.

If you are using the installation CD, the installation process starts automatically and leads you through the necessary steps. If you have downloaded the Installer, simply double-click the **MSI** file to begin the process.

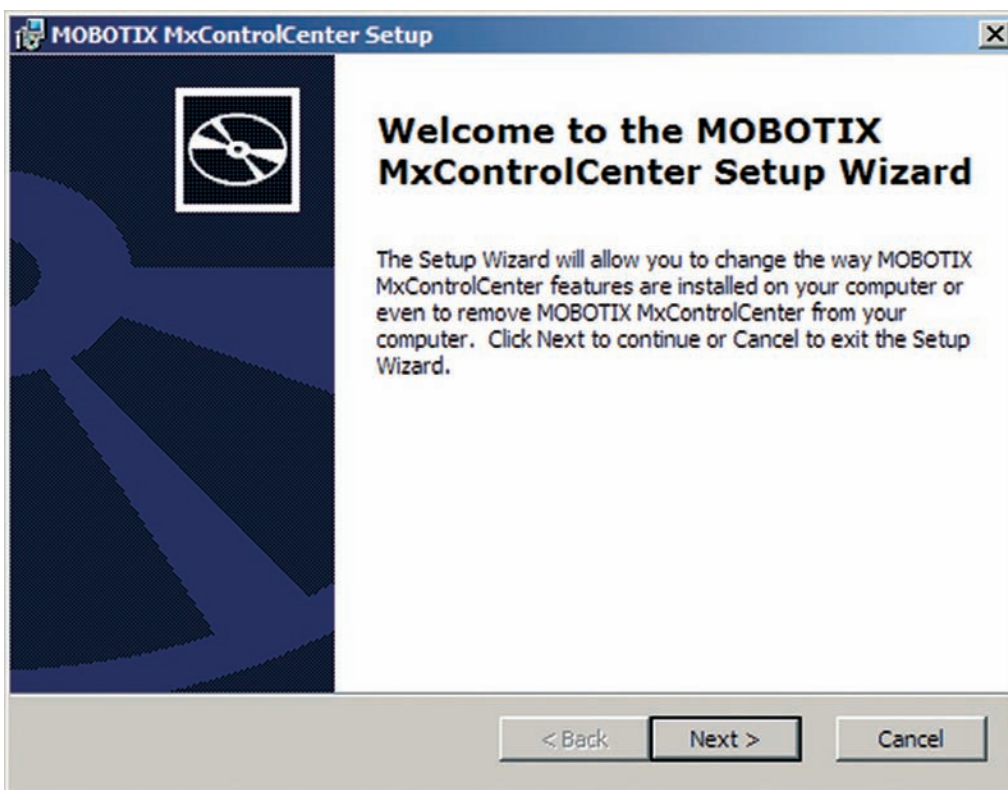

Automatic installation of MxControlCenter with Windows Installer (MSI)

The installer automatically creates the shortcuts selected in the installation process (desktop, start menu, etc.).

Using MxControlCenter for the First Time

Double-click on the shortcut created by the installer (see *Installing MxControlCenter*) or the program file itself to start MxControlCenter.

Automated Search for MOBOTIX Cameras

If you start MxControlCenter for the first time or if you have not yet stored a start layout with the desired video sources (i.e. MOBOTIX cameras), the **Open Video Sources** dialog will open and automatically starts scanning the network.

Automatic search for MOBOTIX cameras!

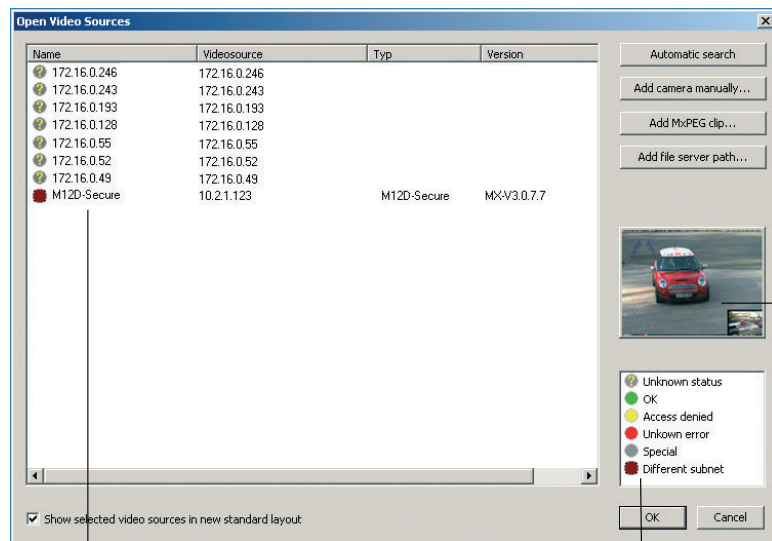

Video sources

Legend Camera preview

After all MOBOTIX cameras have been identified, MxControlCenter performs an operational test on the cameras to determine their status and then lists them according to the legend.

Next, MxControlCenter **automatically selects all cameras**.

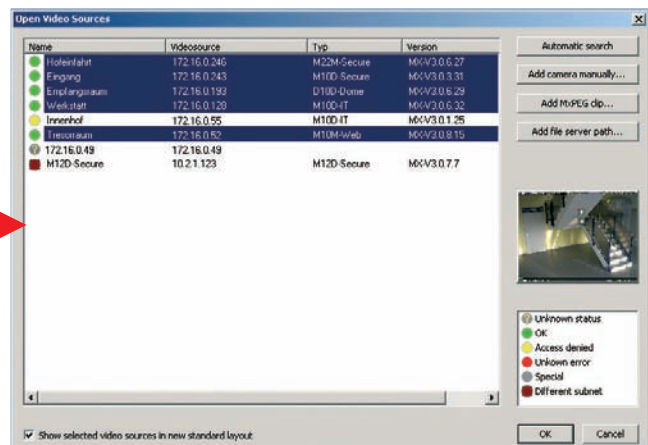
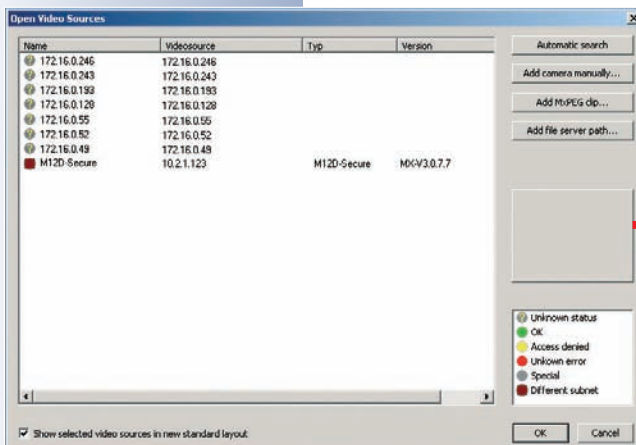

Click on **OK** to add the selected cameras to the **Open Video Sources** dialog.

Anytime you connect a new camera to the local network, you can initiate the search in the **Open Video Sources** dialog again by pushing the [Objekt] button.

If the desired MOBOTIX cameras are highlighted in the video source list, proceed to *Selecting Video Sources*.

Configuring MOBOTIX Cameras for a Different Network

Using Bonjour, MxControlCenter finds not only cameras on the same subnet (network range) but also **MOBOTIX cameras located in other subnets** (status: *Different subnet*). You will not be able to establish any connection to cameras in a different network or subnet (without going into much further detail about the complicated details of TCP/IP network configurations). This can happen, for example, when a camera with a factory IP address is connected to a network in which a DHCP server automatically assigns the IP addresses.

Click on *Configure network* in the context menu and **MxControlCenter will automatically reconfigure this camera** so that it is "integrated" into your existing subnet. However, MxControlCenter first needs some information about the subnet into which the camera will be integrated. You can make these changes in the **Configure Cameras** dialog that is opening automatically.

If your computer gets its IP address automatically from a DHCP server, then this is certainly the best choice for the new camera and most likely for all other cameras which have been found in a different subnet (**Apply to all inaccessible cameras** checkbox).

If you have assigned a fixed IP address to your computer, you will certainly prefer to assign fixed IP addresses (issued by your system administrator) to every camera. In most cases, you should enter a similar configuration as the one found for your computer's **Network Connections** in the **Properties of Internet protocol (TCP/IP)** dialog.

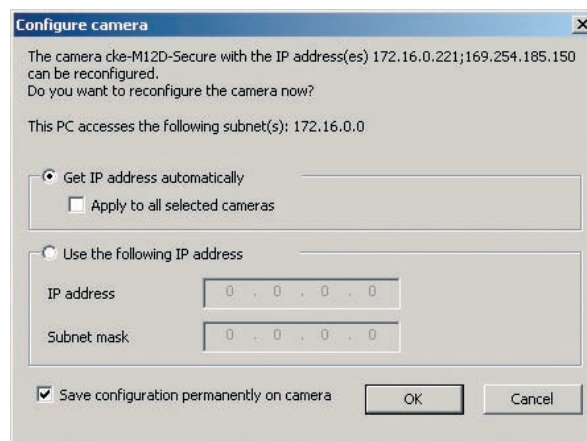

MxControlCenter automatically configures cameras

MxControlCenter changes the network configuration of the current camera and, after a short time, the camera also appears in the list with a new IP address and in the same subnet as your computer.

Make sure that the **Save camera configuration permanently** checkbox is activated so that the new network settings will be used from now on and not just until the camera's next reboot.

Note

If you have set a different user name and password for administration than the factory-preset ones (**admin**, **meinsm**), you will need to have these user credentials ready and enter them in the appropriate dialog. To open the dialog, click on the *Enter password* context menu entry.

Defining Additional Video Sources

Besides automatically detecting MOBOTIX cameras, you can also **manually add other video sources** to the list of available video sources in MxControlCenter.

- **Automatic search:** Scans the (physical) network and finds all MOBOTIX cameras, even if they are not in the same subnet as the computer.
- **Add camera manually:** Enter a known IP address or the DNS name of a MOBOTIX camera if this camera had not been detected during the automatic search in the first place.
- **Add MxPEG clip:** Adds an MxPEG video clip previously recorded by a MOBOTIX camera as a video source.
- **Add file server path:** Adds the alarm images previously stored by a MOBOTIX camera on an external file server as a video source.

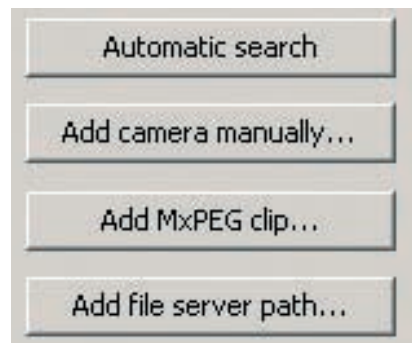

Selecting Video Sources

Highlight the desired video sources you would like to manage and display in MxControlCenter in this list.

Camera preview

If you select a camera with a status of *OK*, MxControlCenter **automatically displays the live images from the camera in the preview window**. If you are using [Ctrl]-click to select several cameras, the image from the camera selected last is shown in the preview window. This feature facilitates identifying the cameras you would like to use.

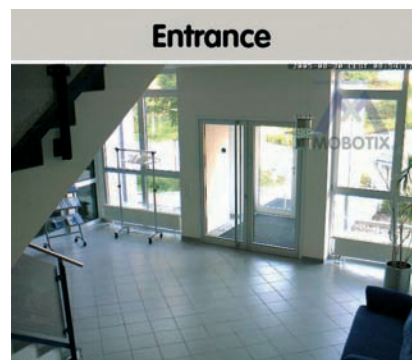

Editing the video source list

This list provides a popup menu (right mouse key), allowing you to select/deselect all video sources at once. Similarly, you can highlight some or all of the listed video sources and remove them from the list if they are not to be displayed or managed in MxControlCenter.

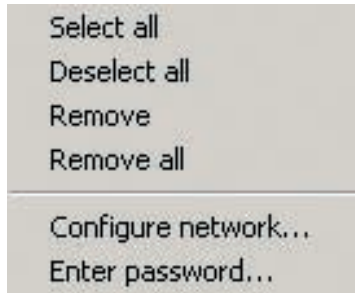

If you interrupt the discovery process (section *Configuring MOBOTIX Cameras for a Different Subnet*) or require a password that is different from the factory preset one, you can always launch the configuration process from the popup menu at a later time and enter the appropriate user name and password.

Using the selected video sources

Clicking on **OK** instructs MxControlCenter to use the highlighted cameras. Activate the **Show selected video sources in new standard layout** checkbox and MxControlCenter automatically generates a layout with the live images of all highlighted cameras.

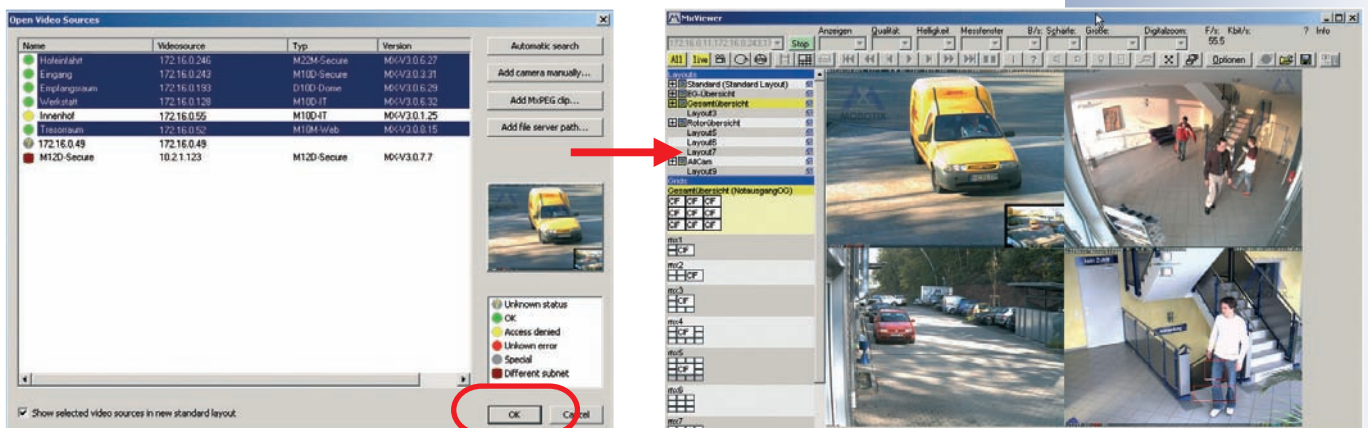

3.5 Starting the Camera With an Automatic IP Address (DHCP)

If your network has a DHCP server, you can start the camera with DHCP support. In this case, the DHCP server automatically assigns an IP address.

As soon as startup has been completed, the camera automatically announces its IP address, its network mask and its MAC address. Please note that this feature needs to be activated for this to work. Note that this announcement function can be deactivated (**Admin Menu > Loudspeaker and Microphone**).

Proceed as follows to start the camera using DHCP:

- If the camera is powered on, disconnect the power supply of the camera by unplugging the corresponding cable.
- Reconnect power to the camera and observe the LEDs.
- Wait until **all six LEDs are lighting up simultaneously**.
- **After the LEDs have lit up, press the "R" key for about one second.**
- LED 5 briefly blinks to acknowledge the command and the camera plays a sound ("Boing, Boing").
- After about another 10 seconds, the camera will announce the network parameters.

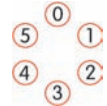

You can now access the camera using the IP address it just announced.



Activate the camera speaker!

Announce IP address:
Press "R" key

In case of an error, the camera uses its last IP address

Note

Simply press the **"R" key** once if you would like to prompt a running camera to announce its network settings.

Caution

When starting the camera with DHCP support, make sure that the network has a properly functioning DHCP server. If this is not the case, the camera cannot obtain a valid IP address and will fall back to its last known IP address.

3.6 Starting the Camera Using the Factory IP Address

Under certain circumstances, you may have to reset the camera to its factory IP address. This could be the case if the IP address of the camera has been lost or the camera does not react to the last known IP address.

Passwords and camera settings will not be changed!

Proceed as follows to start the camera using its factory IP address:

- If the camera is powered on, disconnect the power supply of the camera by unplugging the corresponding cable.
- Reconnect power to the camera and observe the LEDs.
- Wait until **all six LEDs are lighting up simultaneously**.
- **After the LEDs have lit up, press the "L" key for about one second.**
- LED 1 briefly blinks to acknowledge the command and the camera plays a sound ("Boing").



The camera is now accessible again using its factory IP address (see label on the camera housing).



Press "L" key



until this LED blinks



Note

If you use the camera's **"L" key** to load the factory network configuration, this configuration is not automatically saved to flash memory. Upon restarting the camera the next time **without** using the camera's **"L" key**, the *last stored network configuration* will be used. To permanently store the new network configuration in the camera's flash memory, open **Admin Menu > Store ...**

Make sure you store the factory network configuration to the permanent flash memory

Caution

As opposed to resetting the camera using Admin Menu > Reset configuration to factory defaults (see section 1.4.5), the users and passwords defined in the camera will not be reset if the camera is being booted using the factory IP address.

Users and passwords will **not** be changed!

3.7 Connecting External Devices and Sensors: MX Interface Connector and MOBOTIX Cam-IO

3.7.1 MX Interface Connector for Direct Connections



The MOBOTIX camera's MX Interface Connector (D Sub 15 HD) features **one signal input pin** and **one signal output pin for switching loads**. In addition, the interface also provides **two signal inputs and two signal outputs of the RS232 interface**. You can use the camera's signal input/output pins to detect an opening door (using a Reed switch) or to switch an external device (e.g. a lamp).

The interface connector also has Line In/Out pins for external audio devices. You can use the Line In pin to have the camera transmit and record external audio signals (e.g. from an external microphone with pre-amplifier). On the other hand, the camera can use the Line Out pin to transmit sound to external devices (e.g. an audio amplifier). This in turn opens new possibilities as the camera can feed external loudspeakers (such as announcement systems on a train station) or it can use external and more sensitive microphones that can be placed farther away from the

Pin-out of MX Interface Connector D Sub 15 HD					
	Pin	Signal	Alternative	Description	Remarks
	5	GND		Ground for RS232, USB, Backup V-In	
Audio	4	Line-In +		Audio input , Line signal level $U_{RMS}=1V$	Galvanically isolated by transformer (DC decoupled)
	6	Line-In -			
	10	Line-Out +		Audio output , Line signal level $U_{RMS}=1V$	Galvanically isolated by transformer (DC decoupled)
	14	Line-Out -			
In/Out	9	In 1		Signal input , active <0.5V, inactive >+3V, max. voltage 24V	
	1	Out 1		Signal output , OpenCollector, active vs. GND, max. 24V/50mA, inactive 10kOhms vs. 3.3V	
USB	13	USB +5V		Power supply for USB devices 5V/100mA vs. GND	With backup power (12V) or PoE, 500mA also possible
	11	USB D+		USB master data signals , 0V to 3.3V	
	12	USB D-			
Serial interface	2	RxD	RxD RS232	active = -3V to -12V, inactive +3V to +12V	
			RxD I/O	Signal input , inactive: open or voltage >3V, active : GND or voltage <0V, max. $\pm 12V$	
	3	TxD	TxD RS232	active = -3V to -12V, inactive +3V to +12V	
			TxD I/O	Signal output , inactive: <3V max. 3mA, active : >+3V max. 3mA, max. voltage $\pm 12V$	While the system boots, the signal state is undefined
	7	RTS	RTS RS232	active = +3V to +12V, inactive -3V to -12V	
			RTS I/O	Signal output , inactive: <3V max. 3mA, active : >+3V max. 3mA, max. voltage $\pm 12V$	While the system boots, the signal state is undefined
8	CTS	CTS RS232	active = +3V to +12V, inactive -3V to -12V		
		CTS I/O	Signal input , inactive: open or voltage >3V, active : GND or voltage <0V, max. $\pm 12V$		
	15	Backup V-In		Backup power 6V to 12V vs. GND, max. 1A	



camera (e.g. when using a MOBOTIX camera as a video conferencing system and in access control scenarios).

3.7.2 MOBOTIX Cam-IO: Expansion Module for Easy Installation

This expansion module has the following main tasks:

- It represents a unified installation platform with power supply for the MOBOTIX M12 and M22 models with SecureFlex mount.
- It is a unified interface for attaching external sensors (using the signal inputs) and to control external devices using the camera's signal outputs.
- It hooks up directly to utility power and thus can power lamps with up to 500 W (230 V) or 250 W (115 V) or other devices with a power consumption of max. 4 A.
- It can control one more external device using an external relay.
- It allows connecting external amplifiers and microphones (using a pre-amplifier) in order to implement announcement systems or door communication/intercom systems, for example.

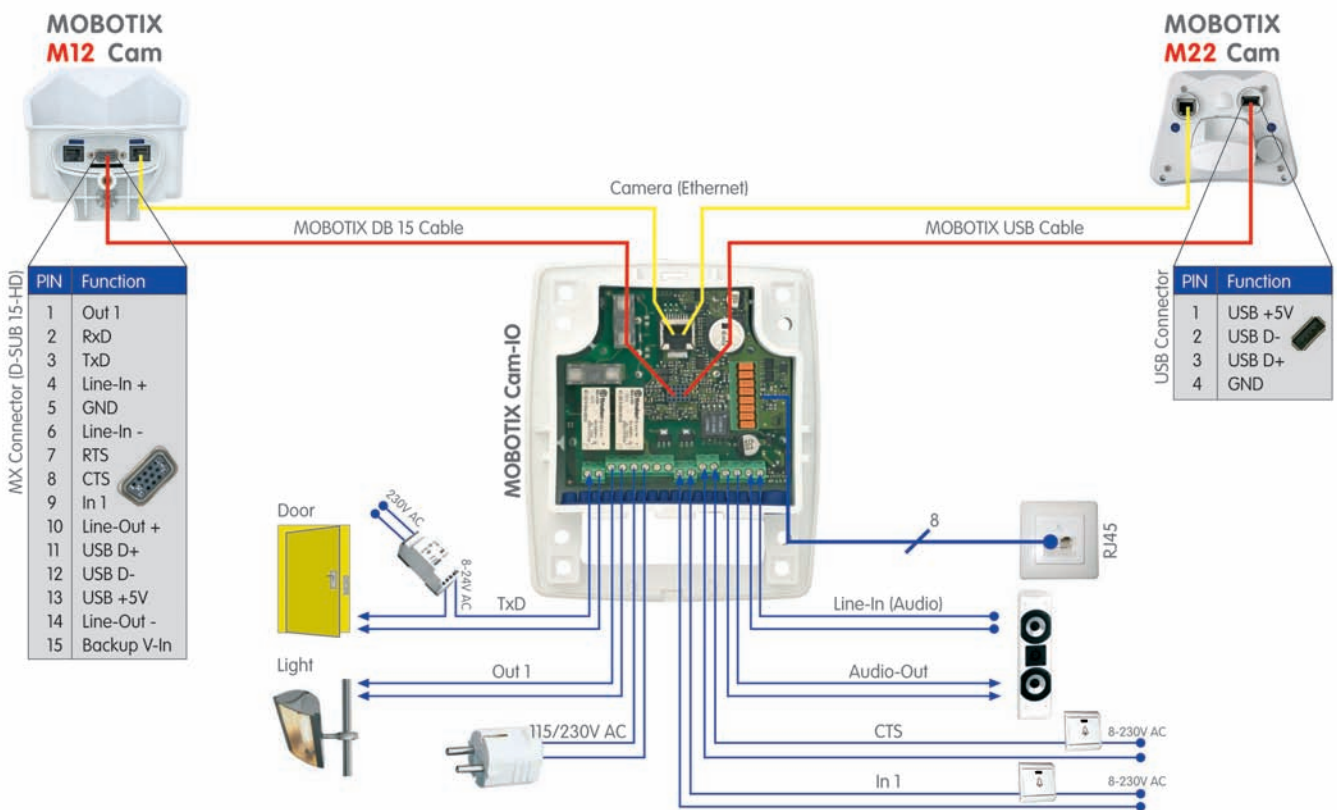
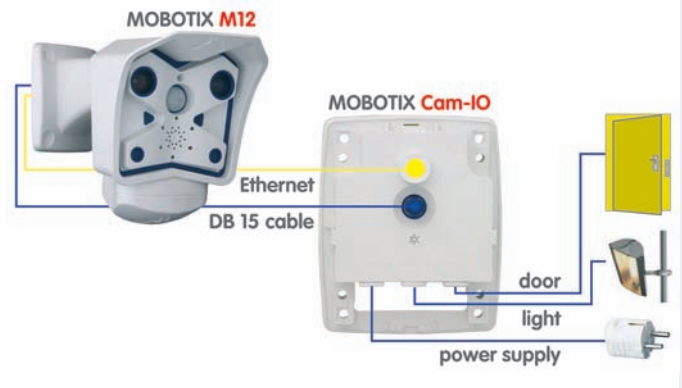

The signal lines of the serial interface can also be programmed as additional signal inputs. **Setup Menu > Event Settings > Second/Third/Fourth Signal Input > Signal Input 1/2/3**. This means that you can use three additional signal input lines

Polarity can be switched

Bridge < 2 kOhms

Integrated low-pass filter: 10 kOhms, 10 nF

3.8 Signal Input/Output, RS232 Interface

The MOBOTIX camera provides a signal input/output as well as two additional signal input pins and two signal output pins on its RS232 interface (not available on WEB and BASIC models). You can use the camera's signal input/output to detect an opening door (using a Reed switch) or to switch an external device (e.g. a lamp using a relay). The signal input/output pins of the RS232 interface can be used for attaching additional sensors and devices.

3.8.1 Signal Input Pins

Pin 9 of the D Sub 15 HD connector is used for detecting the signal input. To trigger the signal input, simply connect pin 5 (ground) to pin 9 (no current required). You can also connect other devices (e.g. SPS machines) that close a contact (0V) to trigger the signal input.

Click on **Setup Menu > Event Settings** to specify which state of the signal input should create an event—an open loop or a closed loop. For example, if you would like to secure all windows and doors of a building, connect all closed switches in a serial loop and connect the wires to signal input (pin 9) and ground (pin 5). The loop should have a resistance of less than 2 kOhms. This pin of the camera is already equipped with a low pass filter (10 kOhms/10 nF).

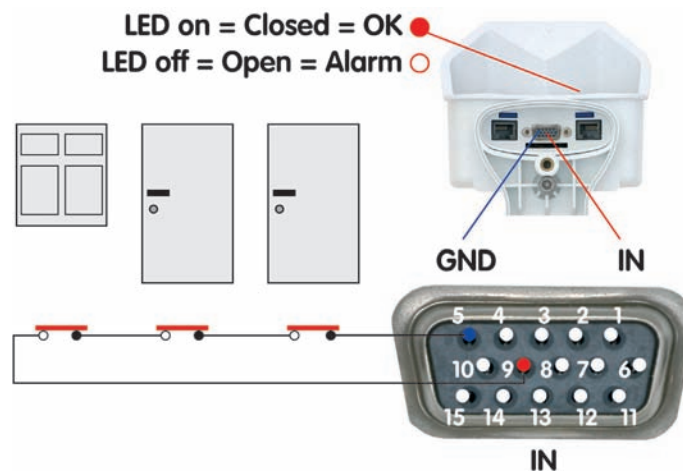

Open **Setup Menu > Event Settings** to activate the additional signal input pins of the RS232 interface (*Closed/Low* or *Open/High* option; CTS: pins 8-5, RxD: pins 2-5). Open **Admin Menu > Setup of serial interface and modem** and configure the serial interface accordingly (**Serial: Data, Mode: I/O Mode**).

Click on **Admin Menu > LED Setup** and set one or more LEDs to *Signal input* to display the state of the input signal for testing (*Signal input* option: loop closed = LED on).

"0": Current higher than +3 V ==> inactive ==> LED off

"1": Current lower than 0.5 V ==> active ==> LED on

3.8.2 Signal Output Pins

When an event is detected, the MOBOTIX camera can switch the signal output (pin 1). Use the corresponding options in **Setup Menu > Actions** to set how long the camera should close the signal output.

- **Off:** Signal output is open (10 kOhms on 3.3 V)
- **1s, 2s, 5s, 10s, 30s, 1min, 5min:** Closes the contact between pin 1 of the D Sub 15 connector and ground (pin 5). The signal output is protected against power surges and unwanted feedback (± 48 V) and switches up to 50 mA. It can thus switch a 12 V relay with 0.6 W and a 24 V relay with 1.2 W.

Open **Setup Menu > Enhanced Signal Out Options** to set custom switching times for any combination of events (not WEB and BASIC models). This dialog also allows using a time table and setting a dead time.

Click on **Admin Menu > LED Setup** and set one or more LEDs to *Signal input* to display the state of the input signal for testing (*Signal input* option: loop closed = LED on).

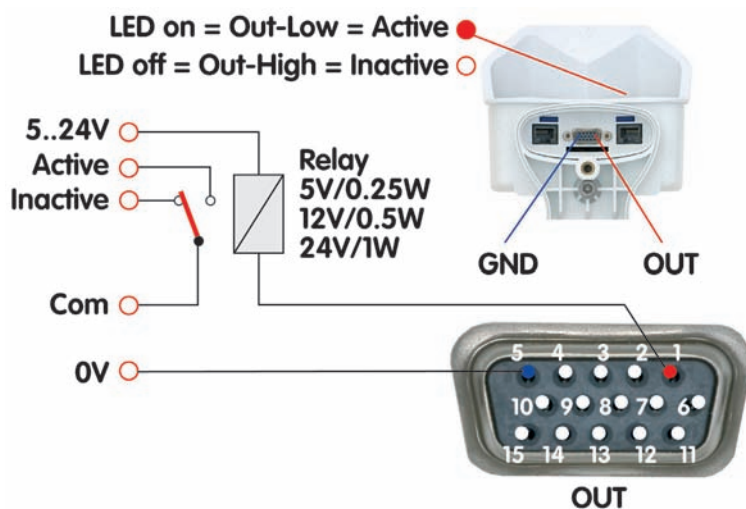

Activate the signal output in **Admin Menu > LED Setup** or for specific events in **Setup Menu > Event Settings**

The event settings allow activating the signal output for a certain time only (to generate an impulse)

Example setup

Select the trigger condition:

- Open (high)
- Closed (low)
- Rising (low to high)
- Falling (high to low)
- Change: (rising or falling)

Besides detecting the current state (open or closed), you may also trigger upon rising, falling or changing signal flanks.

Notes

In contrast to the signal output pins of the RS232 interface (pins **3** and **7**), the signal output pin **1** assumes an inactive state and will stay inactive while the camera is booting.

The *Pin-out of MX Interface Connector D Sub 15 HD* table in section 3.7.1, *MX Interface Connector for Direct Connections*, contains a detailed explanation of the individual pins.

3.9 M12 Drilling Templates (Scale 1:1)

SecureFlex wall mount

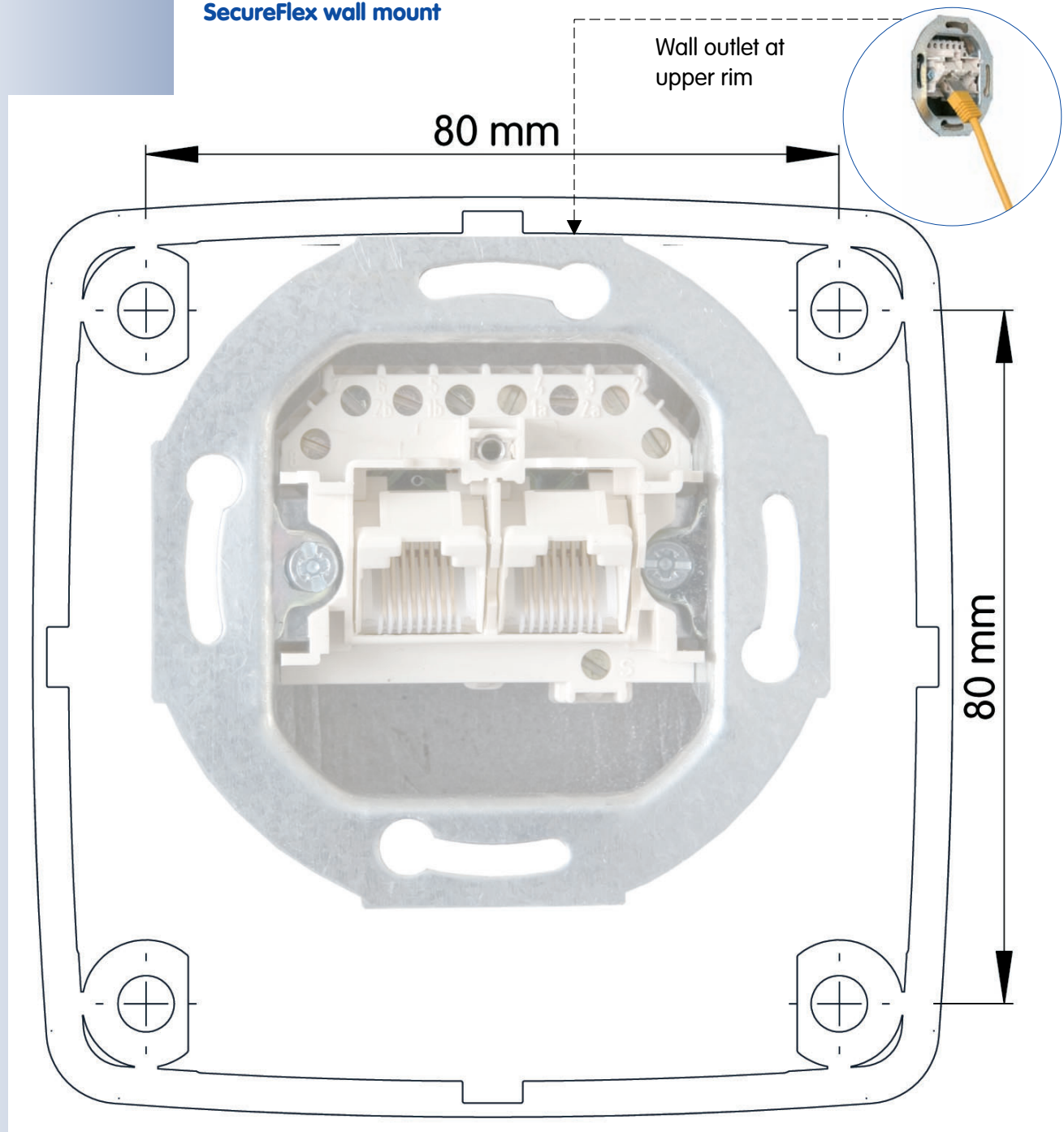

Note

Make sure that the drilling templates are not scaled nor adjusted to the paper size when printing.

When printing the PDF file, you should print two pages onto one to obtain an unscaled printout of the drilling templates.

SecureFlex wall mount (centered wall outlet)

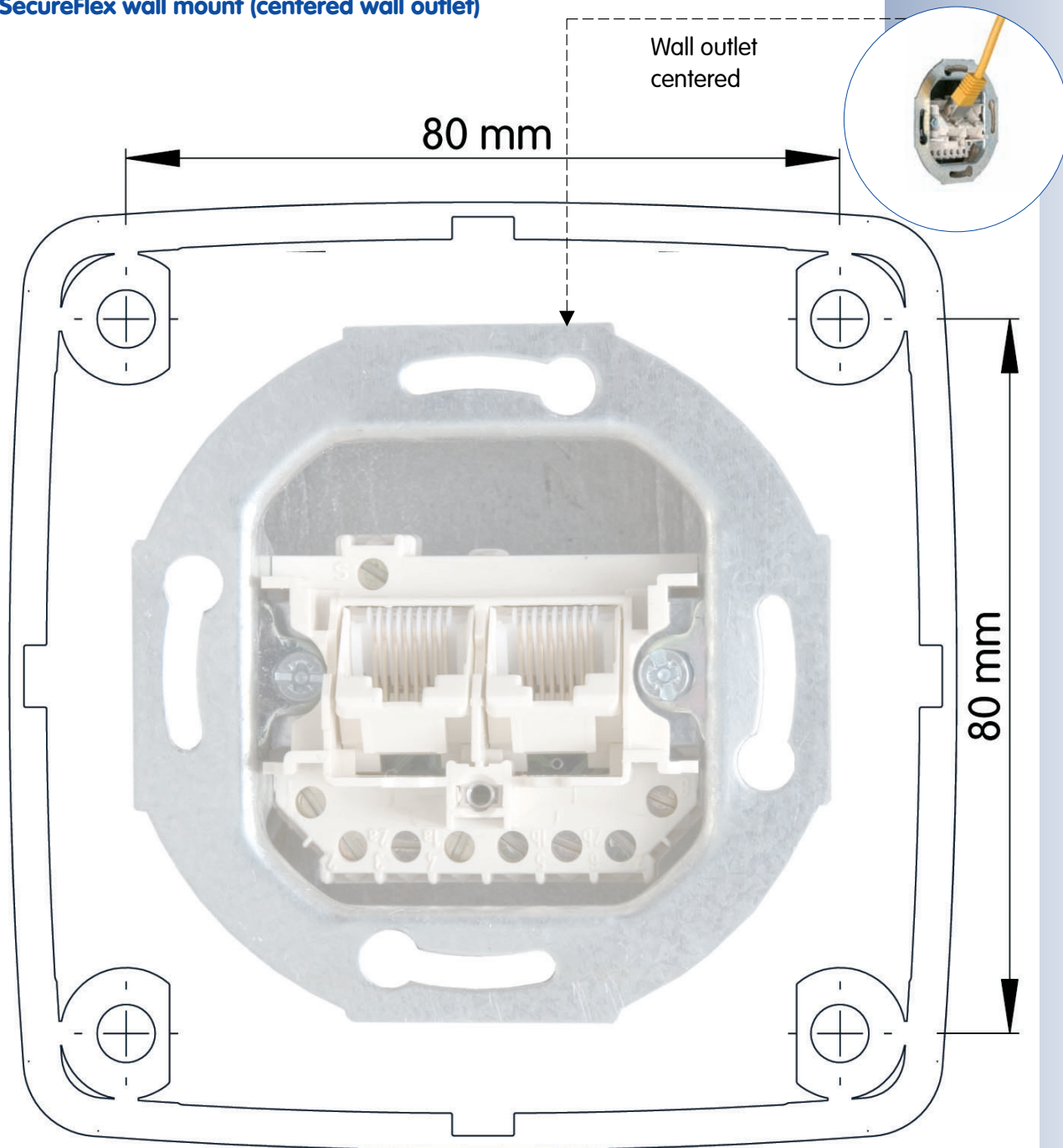







M12 Hardware Features

Outdoor weatherproof (IP65)	IP65	IP65	IP65	IP65	IP65	IP65
Ethernet, ISDN, USB, RS232	E / / - / -	E / / - /R	E / / - /R	E / / - /R	E / / - /R	E / / - /R
SD card	1	1	1	1	1	1
Microphone/speaker	-/S	M/S	M/S	M/S	M/S	M/S
Mono (M) / Dual (D)	M	D	D-Night	D	D-Night	D-Night
Image sensor	Color	Color	Color & BW	Color	Color & BW	Color & BW
Standard lens	L43	L43/L135	L43/L43	L22/L135	L43/L43	L135/L135
Image size	Mega	VGA	VGA	Mega	Mega	Mega
Resolution horizontal x vertical	1280x960	640x480	640x480	1280x960	1280x960	1280x960
Max. frame rate CIF/VGA/Mega	30/30/10	30/30/-	30/30/-	30/30/10	30/30/10	30/30/10
Sensitivity at 1/60 second (Lux)	1	1	0.1	1	0.1	0.1
Sensitivity at 1 second (Lux)	0.05	0.05	0.005	0.05	0.005	0.005
Automatic night lens switch	-	-	X	-	X	X
Storage (MB)	64	64	64	128	128	128
Video ring buffer (MB)	12	32	32	64	64	64
CIF images approx.	750	2.000	2.000	4.000	4.000	4.000
VGA images approx.	450	1.250	1.250	2.500	2.500	2.500
Mega images approx.	150	-	-	800	800	800
External audio (Line-In/Out)	-	X	X	X	X	X
Switch/signal input pins	-	1/2	1/2	1/2	1/2	1/2
Switch/signal output pins	-	1/2	1/2	1/2	1/2	1/2
Concealed cabling	X	X	X	X	X	X
In stock	Yes	Yes	Yes	Yes	Yes	Yes



* not available for M12

 M12  D12  M22M  D22M	Basic Models	Web Models	IT Models	Secure Models
Software Features (All Models)				
Digital zoom (2x, 4x) with panning		X		X
Motion JPEG/MxPEG video streaming	X/X	X/X	X/X	X/X
Custom exposure windows	X	X	X	X
Video Motion detection	X	X	X	X
Time and event control (FTP, email, logos)	X	X	X	X
Time tables with holidays		X	X	X
Web functionality (FTP, email)	X	X	X	X
Quad/MultiView in browser	X	X	X	X
Recording/Playback in browser	X	X	X	X
Logo generator, animations		X	X	X
Single image recording (pre-/post-alarm images)	3	3	10	50
Terabyte ring buffer (Win/Lin/Mac) via network			X	X
Continuous video/audio recording, 0.2 to 30 fps			X	X
Video/audio recording (event-triggered)			X	X
Event-controlled frame rate with continuous audio			X	X
Flexible event logic				X
Master/Slave arming by one camera				X
Scheduled privacy zones, several areas				X
Bidirectional audio (IP) from/to browser			X	X
Customized voice messages			X	X
VoIP telephony (Audio/Video, SIP)			X	X
Alarm calls to softphones (SIP) e.g. Xten			X	X
Remote alarm notification (via TCP/IP, IP Notify)			X	X
RS232 Data Logger/Terminal			X**/**	X**/**
Programming interface/HTTP API			X	X
Model Limitations				
Image size	VGA	Mega	VGA	Mega
Image sensor (color / BW)	Color	Color	Color & BW	Color & BW
Standard lens for software version	L22	L22*	L22*	L22*
Audio support (Microphone/Speaker)	-/-	-/-	M/S	M/S

The Web version is available only as M12 model

The Basic version is available only as D22 model

D22 IT and Secure models allow connecting an external speaker and microphone. From the factory, the D22 does not have a speaker nor a microphone

* M12 models are delivered with L43 lens

** M22M models require the Cam-IO for this feature

*** Not available for D22M models

IP65 Certificate

VDE Prüf- und Zertifizierungsinstitut

VDE VERBAND DER ELEKTROTECHNIK
ELEKTRONIK INFORMATIONSTECHNIK e.V.

**ZERTIFIKAT
CERTIFICATE**

010924

Auftraggeber / Hersteller
Client / Manufacturer

MOBOTIX AG
Luxemburger Strasse 6



67657 Kaiserslautern

Erzeugnis
Product

Autarke Webcam
Autonomous Webcam

Typenbezeichnung
Type designation

M1M-1
M1D-1

Technische Merkmale
Technical characteristics

IP65

Prüfbericht Nr. / Test Report Ref. No.
Ausstellungsdatum / Date of issue

25147-9010-0001/400WM F33/bhl-wu
2001-08-17

Angewandte Normen
Applied standards

DIN EN 60529/VDE 0470 Teil 1:2000-09
EN 60529:1991 + A1:2000

Geprüfte Abschnitte
Tested clauses

12; 13; 14

Ein Muster dieses Erzeugnisses wurde geprüft und die Übereinstimmung mit den angewandten Normen festgestellt. Der oben genannte Prüfbericht ist Grundlage dieses Zertifikates.

A sample of the product has been tested and found to be in conformity with the applied standards. The above mentioned Test Report is part of this certificate.

Dieses Zertifikat darf Dritten nur in Verbindung mit dem oben genannten Prüfbericht im vollen Wortlaut und unter Angabe des Ausstellungsdatums zur Kenntnis gegeben werden.

This certificate may only be passed to a third party in combination with the above mentioned Test Report in its complete wording and the date of issue.

VDE Prüf- und Zertifizierungsinstitut**VDE Testing and Certification Institute**

Fachbereich F3
Department F3

D-63069 Offenbach am Main, 01. Juli 2003
Merianstraße 28



Tel. (+49) (069) 8306-0 · Fax (+49) (069) 8306-716 · e-mail: pi.f33-1@vde.com

DAT-P-024/92-31

Declaration of Conformity

Konformitätserklärung gemäß dem Gesetz über Funkanlagen und Telekommunikationsendeinrichtungen (FTEG) und der Richtlinie 1999/5/EG (R&TTE)

Declaration of Conformity in accordance with the Radio and Telecommunications Terminal Equipment Act (FTEG) and Directive 1999/5/EC (R&TTE Directive)

Déclaration de conformité selon la loi sur les équipements hertziens et les équipements terminaux de télécommunication (FTEG) et la directive 1995/5/EC (R&TTE)

Hersteller/verantwortliche Person: Manufacturer/responsible person: Fabricant/personne responsable :	MOBOTIX AG
erklärt, dass das Produkt: declares that the product: déclare que le produit :	Netzwerk-Kamera Network camera Caméra de réseau
Typ: Type: Type :	M12
Telekommunikations(Tk-)endeinrichtung Telecommunications terminal equipment Équipement de terminal de télécommunication	Netzwerk-Kamera zum Anschluss an das EURO-ISDN Network camera for connection to the EURO ISDN Caméra de réseau pour connecter au RNIS EURO
Verwendungszweck: Intended purpose: Le but suivi :	Übertragung von Bildern und Toninformationen Transmission of images and audio information Transmission d'images et du son
bei bestimmungsgemäßer Verwendung den grundlegenden Anforderungen des § 3 und den übrigen einschlägigen Bestimmungen des FTEG (Artikel 3 der R&TTE) entspricht. complies with the essential requirements of §3 and the other relevant provisions of the FTEG (article 3 of the R&TTE Directive), when used for its intended purpose. est conforme aux exigences fondamentales du paragraphe 3 du FTEG (article 3 du R&TTE) et des autres clauses s'y rapportant.	
Gesundheit und Sicherheit gemäß § 3 (1) 1. (Artikel 3 (1) a)) Health and safety requirements pursuant to § 3 (1) 1. (article 3 (1) a)) Santé et sécurité conformes au paragraphe 3 (1) 1. (article 3 (1) a))	
angewendete harmonisierte Normen: harmonised standards applied: normes harmonisées :	EN 60950:2000 (NSR 73/23/EWG & 93/68/EWG) (LVD 73/23/EWG & 93/68/EC) (Directive Basse Tension 73/23/EWG & 93/68/EC)
Schutzanforderungen in Bezug auf die elektromagn. Verträglichkeit § 3 (1) 2, Artikel 3 (1) b)) Protection requirements concerning electromagnetic compatibility § 3 (1) 2, (article 3 (1) b)) Exigences de protection concernant la compa tibilité électromagnétique, paragraphe 3 (1) 2; (article 3 (1) b))	
angewendete harmonisierte Normen: harmonised standards applied: normes harmonisées :	EN 61000-4-2 EN 55022, Class B (EMV-RL 1995/5/EG (R&TTE)) EN 61000-4-3 EN 55024 EN 61000-4-4 EN 61000-6-2 (EMCD 1995/5/EG (R&TTE)) EN 61000-4-5 EN 61000-6-3 (Directive EMC 1995/5/EG (R&TTE)) EN 61000-4-6 EN 61000-4-11
Anschrift: Address: Adresse :	MOBOTIX AG Luxemburger Str. 6 67657 Kaiserslautern Germany
+ TK-Nr. / Phone number / N° de communication:	
Fon: Fax: E-Mail:	+49 (631) 3033-100 +49 (631) 3033-190 info@mobotix.com
Kaiserslautern, 01.08.2006	
Ort, Datum Place & date of issue Lieu et date	Dr. Ralf Hinkel Vorstand/CEO, MOBOTIX AG Name und Unterschrift Name and signature Nom et signature

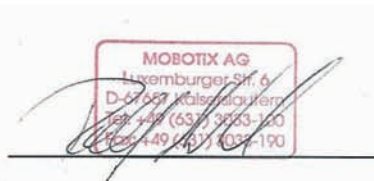

MOBOTIX – The HiRes Video Company

Security-Vision-Systems



To demonstrate our confidence in the quality of our products,
MOBOTIX cameras were used to capture all the images that
appear in this manual.

Manufacturer

MOBOTIX AG

Kaiserstrasse

D-67722 Langmeil

Germany

Tel : +49 6302 9816-103

Fax: +49 6302 9816-190

<http://www.mobotix.com>

sales@mobotix.com

Executive Board

Dr. Ralf Hinkel

Registration Office: Kaiserslautern Local Court

Registration Number: HRB 3724

Tax Code: 44/676/0700/4

Tax Office: Worms-Kirchheimbolanden, Germany

VAT ID:

DE202203501

You can find the latest version of this document
at www.mobotix.com under **Support**.



Technical specifications subject to change without notice!

© MOBOTIX AG • Security-Vision-Systems • Made in Germany

www.mobotix.com • sales@mobotix.com

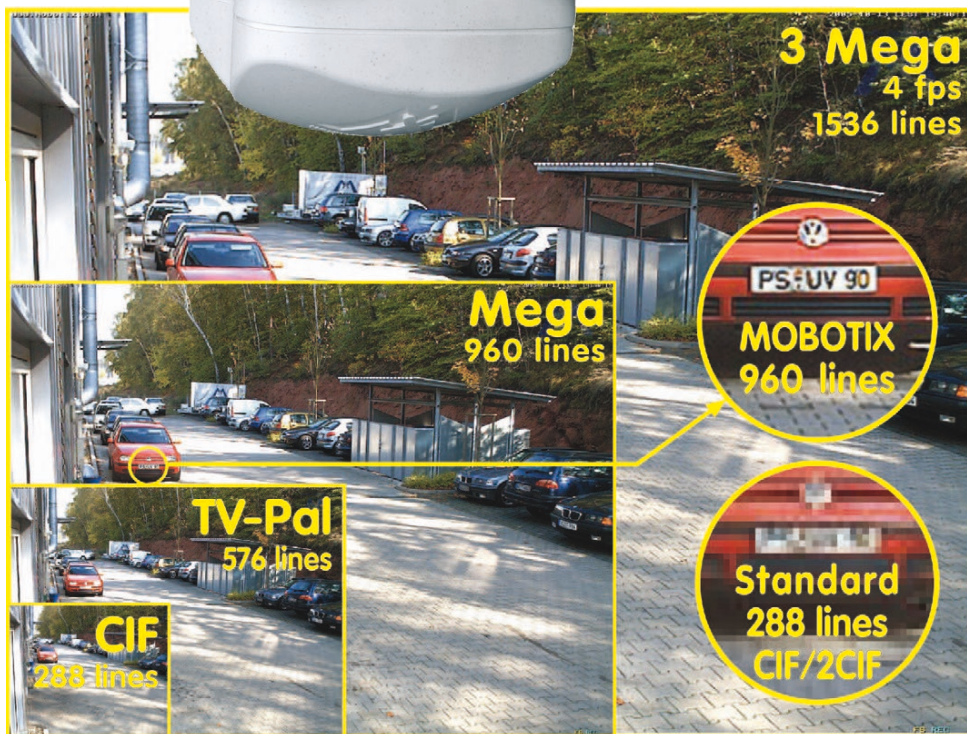

Two Eyes. 100,000 Reasons.

MOBOTIX dual lens, day/night camera with two separate HiRes image sensors is successfully in use in over 100,000 installations worldwide. Brilliant color for the day and extremely light-sensitive black/white sensor for the night. The intelligent and robust professional solution from MOBOTIX with no moving parts!

HiRes
3 Megapixels
 2048 x 1536
 Software zoom

Skyline
Format free
 Each image format
 freely definable

MxPEG
30 Frames/s
 VGA (640 x 480)
 10 F/s 3Mega

Virtual PTZ
 Digital pan, tilt,
 zoom

Backlight
 Safe using CMOS
 without mechanical iris

Internal DVR
 Internal via Flash,
 external via Network

Win/Lin/Mac
Recording
 Via Netzwerk on PC
 up to 1 Terabyte

Microphone & speaker
Audio
 Bi-directional, via IP,
 variable frame rates

SIP client with video
IP Telephony
 Alarm notify,
 camera remote control

VideoMotion
 Multiple windows,
 precision pixel-based

-22 to +140°F
Weatherproof
 -30 to +60°C, IP65,
 no heating necessary

IEEE 802.3af
PoE
 Network power
 even in winter

Robust
 No moving parts,
 fiber glass housing

MxCC/MxEasy
License free
 Video Management
 Software

HiRes Video Innovations

The German company MOBOTIX AG is known as the leading pioneer in network camera technology and its decentralized concept has made high-resolution video systems cost efficient.

MOBOTIX AG • D-67722 Langmeil • Tel: +49-6302-9816-103 • Fax: +49-6302-9816-190 • sales@mobotix.com