

Conettix Universal Dual Path Communicator

B465



BOSCH

en Installation and Operation Guide

Table of contents

1	Safety	5
2	Introduction	6
2.1	About documentation	6
2.2	Bosch Security Systems, Inc. product manufacturing dates	7
2.3	Installation workflow	7
3	System overview	9
3.1	Module overview	9
3.2	PSTN input reporting format compatibility	13
3.3	Digital communication	13
3.3.1	Telephone line voltage	13
3.4	B46 overview (optional)	14
4	Installation	16
4.1	Remove enclosure knockouts	16
4.2	Mount the enclosure	17
4.3	Insert wiring label	18
4.4	Insert D101 lock (optional)	19
4.5	Insert B46 LED cover (optional)	19
4.6	Install the module	20
4.6.1	Mount the module	20
4.6.2	Mount the B46 (optional)	22
4.6.3	Connect earth ground	24
4.7	Insert the cellular communication module (optional)	25
4.8	Wiring installation	25
4.8.1	System wiring	25
4.8.2	Control panel to dialer capture wiring	27
4.8.3	Control panel to dry contact wiring	27
4.8.4	B46 module wiring (optional)	28
4.8.5	Input loop wiring	29
4.8.6	Output wiring	31
4.8.7	Input power supply wiring	32
4.8.8	D1640-120W1 transformer wiring (optional)	34
4.8.9	12 VDC battery wiring	34
5	Communications	39
5.1	IP communication	39
5.1.1	On-board Ethernet connection	39
5.1.2	Conettix Plug-in Cellular Communicators	40
5.1.3	Compatible receivers for IP communication	40
5.1.4	Communication routing	41
6	Configuration	43
6.1	Use USB to configure the B465	43
6.2	Install a serial communication program	44
6.3	Log into the USB interface	47
6.3.1	USB Main menu screen	48
6.3.2	USB menu structure	50
6.3.3	USB menu options	52
6.3.4	Status menu	54
6.3.5	Advanced Status menu	57

6.3.6	Standard Communication Configuration	59
6.3.7	Advanced Communication Configuration	60
6.3.8	System Configuration	63
6.3.9	Input Configuration	67
6.3.10	Relay Configuration	68
6.3.11	Maintenance	70
6.4	Firmware Update page	71
7	Maintenance and troubleshooting	75
7.1	LED status indicators	75
7.2	Show the firmware version	81
7.3	Diagnostic log	82
7.4	Understanding network polling	82
7.5	Troubleshooting procedures	82
7.5.1	No power on the B465	82
7.5.2	Initialization - cellular	82
7.5.3	Hardware	83
7.5.4	Firmware	83
7.5.5	SIM card	83
7.5.6	PIN code	83
7.5.7	Cellular network registration	84
7.5.8	USB COM port error	84
7.6	Testing the system	85
8	Specifications and certifications	87
8.1	Technical specifications	87
8.1.1	B465 power supply specifications	88
8.1.2	Application environment	89
8.1.3	Standby battery requirements and calculations	90
8.1.4	24 VDC Input power requirements	91
8.1.5	Required programming to meet UL 864	91
8.1.6	Required programming to meet ULC-S304	92
8.1.7	Compatible UL listed components	93
8.2	Certifications	96

1

Safety

ESD precaution



Please note that the B465 and optional cellular communication modules come in a plastic bags, and are protected from ESD. All plug-in cellular communicator components may potentially be exposed to finger touches - therefore extra attention must be paid to ESD (electrostatic discharge) precaution. Make sure there is no static interference when using the board. Appropriate ESD protections must be taken and wearing electrostatic equipment is recommended, such as anti-static wrist strap.

ESD damage can range from subtle performance degradation to complete device failure. Precision integrated circuits may be more susceptible to damage because very small parametric changes could cause the device not to meet its published specifications.



Warning!

Failure to follow these instructions can result in a failure to initiate alarm conditions. Bosch Security Systems, Inc. is not responsible for improperly installed, tested, or maintained devices. Follow these instructions to avoid personal injury and damage to the equipment.



Notice!

Inform the operator and the local authority having jurisdiction (AHJ) before installing the module in an existing system.

Disconnect all power to the control panel before installing the module.

2 Introduction

The B465 Conettix Universal Dual Path Communicator (referred to as the B465) links the PSTN digital dialer and/or dry contact inputs from a control panel to an IP connection (Ethernet or Cellular) to the D6600 or D6100i Communication Receiver/Gateway through an internet connection.

The need to reprogram the control panel's automation from PSTN to IP operations is not required when the B465 is installed. This conversion occurs within the Bosch Conettix Receiver. All messages generated internally by the B465 are sent to the central station in Contact ID format.

When the control panel's PSTN dialer sends a message, the module simulates a public switched telephone network (PSTN) connection to the central station. The module decodes the control panel's PSTN dialer report and sends the decoded reports by IP connection using Bosch's Conettix Protocol to the Conettix D6600, D6100IPv6, or D6100i Communication Gateway/Receiver (referred to as the receiver). When the receiver acknowledges receipt of the message, it sends an acknowledgement report to the module which in turn sends an acknowledgement to the connected control panel. This process maintains true end-to-end security.

The module has the following connections:

- Ethernet connects to the network
- dry contact programmable inputs (4x)
- 3 programmable relay outputs, if necessary, to indicate conditions to the control panel, if required
- Control panel Phone line inputs to the B465 (2x).
- B44x Cellular Module (optional)
- B46 External Annunciator (optional)

2.1 About documentation

Copyright

This document is the intellectual property of Bosch Security Systems, Inc. and is protected by copyright. All rights reserved.

Trademarks

All hardware and software product names used in this document are likely to be registered trademarks and must be treated accordingly.

Bosch includes the open source software modules listed below in the firmware for this control panel. The inclusion of these modules does not limit the Bosch warranty.

Software acknowledgement

Time routines

Copyright © 2002 Michael Ringgaard. All rights reserved.

This software [Time routines] is provided by the copyright holders and contributors "as is" and any express or implied warranties, including, but not limited to, the implied warranties of merchantability and fitness for a particular purpose are disclaimed. In no event shall the copyright owner or contributors be liable for any direct, indirect, incidental, special, exemplary, or consequential damages (including, but not limited to, procurement of substitute goods or services; loss of use, data, or profits; or business interruption) however caused and on any theory of liability, whether in contract, strict liability, or tort (including negligence or otherwise) arising in any way out of the use of this software, even if advised of the possibility of such damage.

Redistribution and use in source and binary forms, with or without modification, are permitted provided that the following conditions are met:

1. Redistributions of source code must retain the above copyright notice, this list of conditions and the following disclaimer.
2. Redistributions in binary form must reproduce the above copyright notice, this list of conditions and the following disclaimer in the documentation and/or other materials provided with the distribution.
3. Neither the name of the project nor the names of its contributors may be used to endorse or promote products derived from this software without specific prior written permission.

RSA data security

Copyright © 1991-2, RSA Data Security, Inc. Created 1991. All rights reserved. The "RSA Data Security, Inc. MD5 Message-Digest Algorithm" is included in the module firmware.

RSA Data Security, Inc. makes no representations concerning either the merchantability of this software or the suitability of this software for any particular purpose. It is provided "as is" without express or implied warranty of any kind.

2.2 **Bosch Security Systems, Inc. product manufacturing dates**

Use the serial number located on the product label and refer to the Bosch Security Systems, Inc. website at <http://www.boschsecurity.com/datecodes/>.

2.3 **Installation workflow**

To install and configure the module, use the workflow below and follow in sequential order from top to bottom, checking off each box as you complete a step.



Caution!

Always power down the B465 when connecting a module. To power down the B465, unplug the transformer and disconnect the battery.

Installation workflow checklist

- Plan the installation of the B465
- Unpack the device contents
- Power down the system
- Install the enclosure (Refer to *Mount the enclosure, page 17*)
- Mount the B465 into the enclosure (Refer to *Install the module, page 20*)
- Mount the B46 (module and cover) into the enclosure (Refer *Insert B46 LED cover (optional), page 19*)
- Insert the desired plug-in communicator into the B465 (if required) (Refer to *Insert the cellular communication module (optional), page 25*)
- Wire the B465 to a compatible control panel (Refer to *Wiring installation, page 25*)
- Power up the system
- Install a communication program (if required) (Refer to *Communications, page 39*)
- Configure the communication module
- Verify LED activity (Refer to *LED status indicators, page 75*)
- Review signal strength on the cellular communicator (if required). Refer to your cellular communicator Installation Guide for more information on signal strength.
- Installation is complete

3 System overview

Refer to the figure below for the complete module configuration.

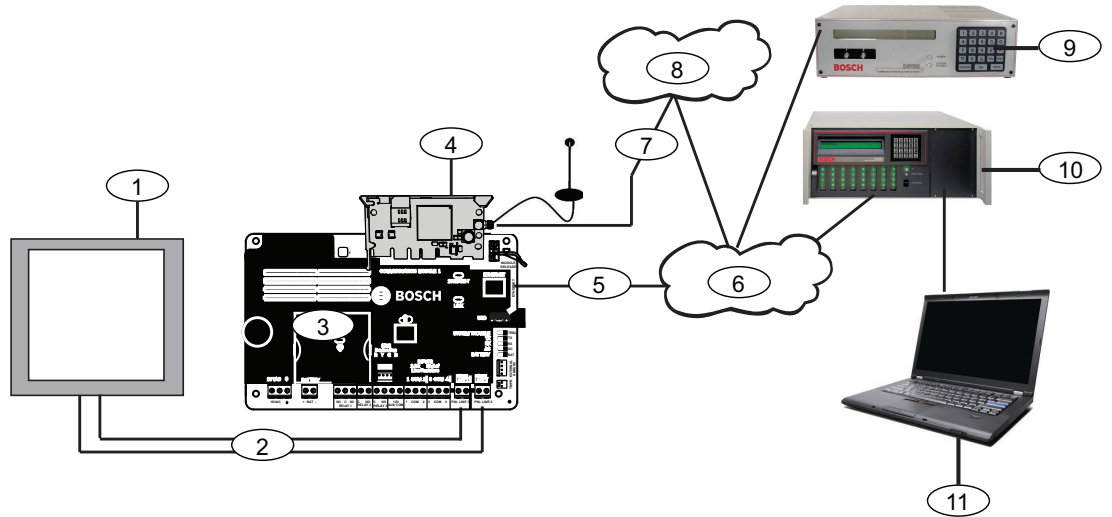

Figure 3.1: System connection overview

Callout — Description	Callout — Description
1 — Intrusion/fire control panel	7 — Cellular communication to cellular carrier
2 — Phone line connections (phone line 1 and phone line 2)	8 — Cellular carrier network
3 — B465 Conettix Universal Dual Path Communicator	9 — Conettix receiver/gateway (D6100IPv6 shown)
4 — B44x plug-in cellular communicator	10 — Conettix receiver (D6600 shown)
5 — Ethernet connection (RJ-45 cable connection to the LAN/WAN)	11 — Monitoring center automation (classified per UL 1981)
6 — Internet	

3.1 Module overview

The B465 Conettix Universal Dual Path Communicator allows any fire and intrusion control systems with PSTN dialers and/or dry contact inputs to communicate with Bosch receivers to the central monitoring station over Ethernet or cellular networks through IP. This allows customers using control panels developed before the introduction of networking and cellular to eliminate costly phone lines and gain some of the modern performance that IP networking enables

The B465 Conettix Universal Dual Path Communicator is suitable for use with any one of the following standard digital dialer formats:

- Ademco Contact ID (SIA DC-05) +10 digit account codes
- Pulse 3/1, 3/1 Checksum (2300 Hz ACK Tone)
- Pulse 3/1, 3/1 Checksum (1400 Hz ACK Tone)
- Pulse 4/2 (2300 Hz ACK Tone)
- Pulse 4/2 (1400 Hz ACK Tone)

- SIA (SIA8, SIA20)

This process described is why Bosch provides true end-to-end security. The module links the control panel's PSTN dialer to the internet and then to one of the Bosch Conettix receivers.

The B465:

- Connects with the control panel's PSTN dialer or relay output connected to the B465 inputs
- Decodes and delivers alarm messages to a Conettix D6600, D6100i or D6100IPv6 Communications Receiver/Gateway through network communications
- The Conettix receiver replies to the B465 with an acknowledgement of the message
- The B465 sends an acknowledgement back to the control panel through the PSTN interface which completes the signal transmission

Refer to the following illustration for component locations on the module.

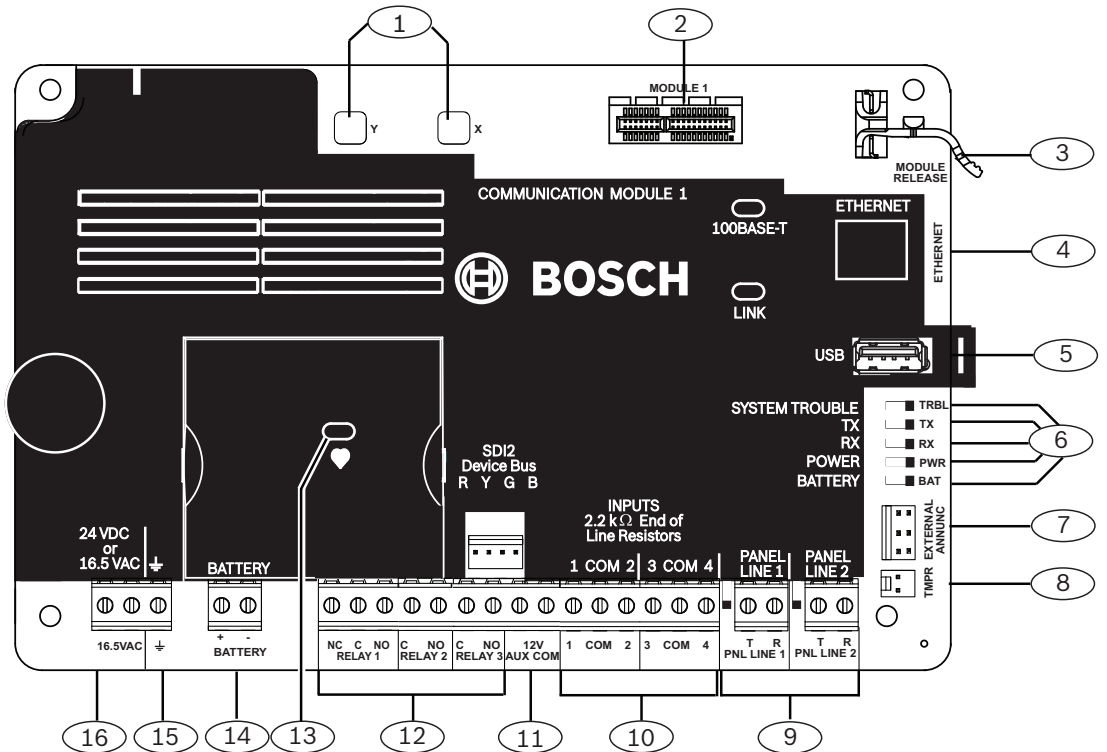

Figure 3.2: module overview

Callout — Description	Callout — Description
1 — Holes to stabilize the plug-in cellular module	9 — Control phone line terminals
2 — Plug-in module connector	10 — Input terminals – end-of-line resistor (EOL) loop supervised (1 to 4)
3 — Plug-in module retention clip	11 — 12V auxiliary (AUX)/COM terminals (optional output power source, Special Application 9.9 – 13.8 V)
4 — On-board Ethernet connection	12 — Programmable output relays for connection to a control panel
5 — USB connector	13 — Heartbeat LED
6 — Status LEDs (Trouble, TX, RX, PWR, Bat)	14 — 12 VDC lead-acid battery terminals
7 — B46 External annunciator interface connector	15 — Earth ground terminal
8 — Tamper switch connector	16 — 16.5 VAC or 24 VDC power supply input terminals



Notice!

The *SDI2 Device Bus* terminal connector located about callouts 11 and 12 is for future use. The *SDI2 Device Bus* terminal connector has not been tested by UL.

Component details

- ① Stabilization holes. Insertion holes used to stabilize the cellular plug-in modules
- ② Plug-in module connector. Insertion location for the cellular module board into the B465.
- ③ Module retention clip. This clip is used to attach/release the cellular module by pulling the tab towards you.
- ④ On-board Ethernet connection. This connection is used for IP communications to the D6600 or D6100IPv6 receiver.
- ⑤ USB connection. Used for programming, viewing status, and troubleshooting. Temporary connection.
- ⑥ TRBL, TX, RX, PWR, BAT. Status LEDs used for providing status and operational conditions of the B465. TRBL, PWR and BAT signals are transmitted through the B46 cable to the B46 external annunciator. These LED states display through an external cover plate mounted on the exterior of the B10/B10R, or D8103 enclosure door.
- ⑦ EXTERNAL ANNUNC. Optional B46 interface connector. Connects to the B46 external annunciator module through a cable that displays LED status on the exterior of a B10, or D8103 enclosure door. LEDs displayed are System Trouble (TRBL), Power (PWR), and Battery (BAT).
- ⑧ TMPR. Used for installing the ICP-EZTS Tamper Switch. Use this tamper switch on B10(R) and B11(R) enclosures. By default, this connection is disabled. Tamper is required for Commercial Burglar installations.
- ⑨ PNL LINE 1, PNL LINE 2. Phone line inputs used to connect/communicate to supporting fire control panels. Both lines run 28 VDC and support DTMF (Contact ID), Pulse 3/1, Pulse 4/2, and SIA Communication formats. Each individual phone line connection on the B465 can be configured to be disabled if there is a comm fail on the B465. This will cause a trouble at the connected control panel if its configured for supervised phone lines.
- ⑩ 1 COM 2, 3 COM 4. These four inputs on the B465 connect to dry contact outputs on the control panel and generate reports instead of using a phone line connection. These functions are configurable from the USB menu:
 - Panel System Trouble
 - Panel AC Fail
 - Panel Battery Trouble
 - Fire Alarm
 - Fire Trouble
 - Burg Alarm
 - Burg Trouble
 - Fire SupervisoryEach input allows of dry contacts or powered outputs up to 30 VDC if needed. The inputs use 2.2K EOLs (P/N: F01U034506) to monitor the dry contact outputs when connected to dry contacts. The inputs recognize the following thresholds: 2.0 to 3.0 VDC = Normal, 3.7 to 5.0 VDC = normal, 0.0 to 1.3 VDC = short.
- ⑪ 12V AUX/COM. Used to support a 12 VDC – 0.5 A auxiliary power supply for other applications as needed (Special Application 9.9 – 13.8 V).
- ⑫ RELAY 1 output has a rating of 30 VDC, 0.5 A. RELAY 2 and RELAY 3. Are programmable outputs with a rating of 30 VDC, 0.1 A. Potential output responses include:
 - System Trouble
 - AC Fail

- Battery Trouble
 - ALL Comm Fails
 - Ethernet Comm Fail
 - Cellular Comm Fail
- ⑬ Heartbeat. Used to give operational status of the B465 module.
- ⑭ BATTERY. A 12 V 7-18 Ah Lead Acid battery that provides back-up power for the B465 module.
- ⑮ Earth Ground. Used for earth ground transient protection and reduced emissions.
- ⑯ 24 VDC or 16.5 VAC. Used to attach the D1640 plug-in transformer, D1640-CA plug-in transformer, D1640-120WI wired-in transformer. These transformers have a rating of 16.5 VAC, 40 VA. The input also accepts an optional 24 VDC from a UL listed fire control panel or power supply.

**Notice!**

A D8004 Transformer Enclosure is required for Commercial Fire applications if you are using either the D1640 or D1640-CA plug-in transformers.

3.2

PSTN input reporting format compatibility

The module is suitable for use with of the following standard digital dialer formats:

- Ademco Contact ID (SIA DC-05) +10 digit account codes
- Pulse 3/1, 3/1 Checksum (2300 Hz ACK Tone)
- Pulse 3/1, 3/1 Checksum (1400 Hz ACK Tone)
- Pulse 4/2 (2300 Hz ACK Tone)
- Pulse 4/2 (1400 Hz ACK Tone)
- SIA (SIA8, SIA20)

3.3

Digital communication

The B465 module uses its built-in Ethernet connection, and/or a Conettix Plug-in cellular module (B440/B441/B442/B443) to send reports to the central station receiver. The system routes event reports to the primary and backup destinations using ethernet or cellular communication, depending on configuration.

3.3.1

Telephone line voltage

The module simulates a conventional phone line to the control panel it is connected with. The module supplies a constant phone voltage of 28 VDC (on hook) to satisfy the connected control panel's phone line monitor. The module's phone voltage is between 3-8 VDC when the control panel attempts to communicate (off hook).

The module can be programmed to remove the phone voltage when there is a communication failure between the B465 and connecting control panel. This allows the local control panel to be notified that there is a problem by removing the phone line voltage from the terminal. This causes a trouble to occur at the connected control panel as intended.

3.4 B46 overview (optional)

The B46 is an optional module that provides external B465 LED and sounder status when installed in a supported enclosure. The module has 3 LEDs (System Trouble, Power, and Battery) which illuminate through the B46 LED cover. The LED cover snaps into a knockout in the enclosure door. The B46 fits in the B10/B10R, D8103 enclosure. Refer to the following figure for component locations.

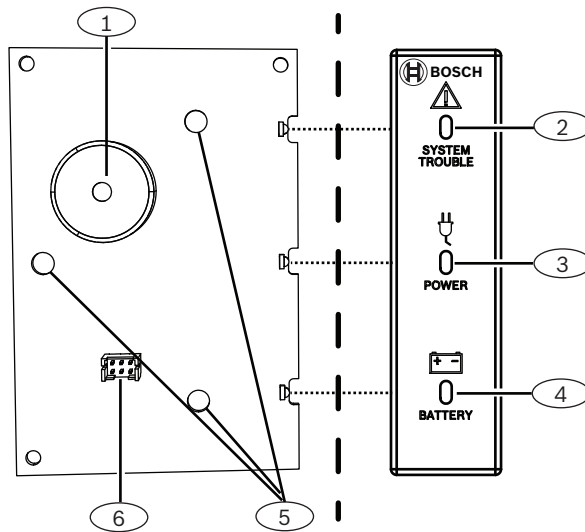

Figure 3.3: B46 module overview

Callout	Description
1	— Sounder
2	— SYSTEM TROUBLE LED
3	— POWER LED
4	— BATTERY LED
5	— 3-hole mounting pattern
6	— B46/B465 cable connection

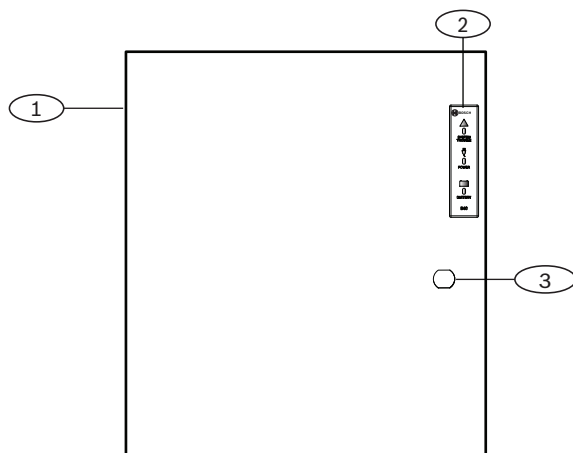

Figure 3.4: B46 LED cover (B10 enclosure shown)

Callout — Description
1 — B10 Medium Control Panel Enclosure, door closed
2 — B46 LED cover
3 — Enclosure lock (D101 supplied separately)

For LED patterns, refer to *LED status indicators*, page 75.

4 Installation

Perform the following steps to install the module.

**Notice!**

Notify the central station and any additional local authority before installing the B465 in an existing system.

**Notice!**

B46 External Annunciator installation

Refer to the *B46 External Annunciator Installation Guide* (P/N: F01U312441) prior to installing the enclosure for B465 module. There is a specific installation sequence you must follow to avoid damaging the B46 module during the installation process.

**Caution!**

Remove all power (AC and battery) before making any connections. Failure to do so might result in personal injury and/or equipment damage.

4.1 Remove enclosure knockouts

Review knockout locations before installing the enclosure on the wall. Each enclosure is slightly different regarding knockout locations and your desired use. Use a hammer and a punch-out tool to remove knockouts. Refer to the figures in this section for knockout locations.

Removing knockouts:

1. Review your wiring environment and decide on the appropriate knockouts to remove.
2. Lightly strike the wiring knockouts with a hammer and a punch-out tool.
3. Remove the metal knockout from the enclosure using pliers.
4. Lightly strike the 3-hole mounting knockouts with a hammer and a punch-out tool.
5. Remove the metal knockout from the enclosure using pliers.
6. Lightly strike the four corners of the enclosure door knockout when installing the B46 LED cover.
7. Remove the metal knockout from the enclosure using pliers.

**Caution!**

Insert conduits into the enclosure knockout areas when running wire or cabling to reduce wire/cable damage.

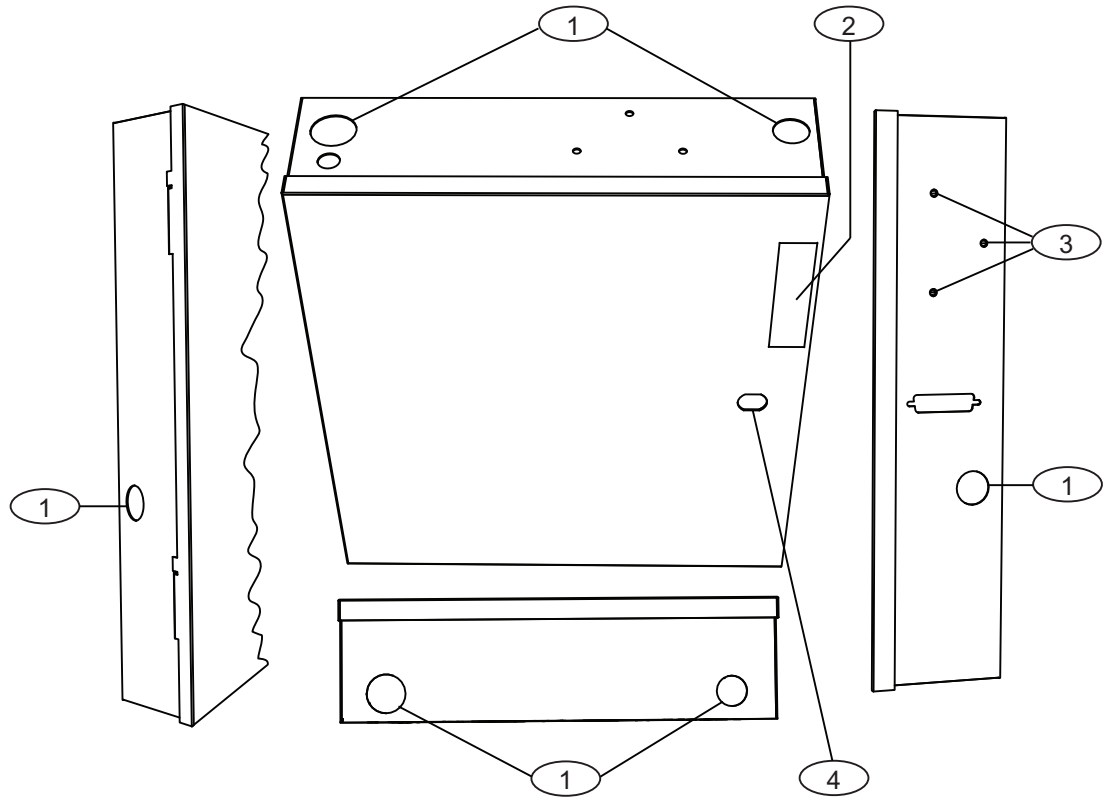

Figure 4.1: Suggested knockout locations

Callout	Description
1	Suggested knockout locations for B465 wiring
2	Knockouts in enclosure door for B46 LED cover (optional for non-fire applications)
3	3-hole mounting knockouts for B46
4	Lockset mounting knockout

4.2 Mount the enclosure

Mount one of the following enclosures in the desired location to meet desired UL requirements:

- B10 Medium Control Panel Enclosure (white)
- B10R Medium Control Panel Enclosure (red)
- B11 Small Control Panel Enclosure (white)
- B11R Small Control Panel Enclosure (red)
- D8103 Universal enclosure (this enclosure requires the B12 mounting plate)
- D8108A Attack Resistant Enclosure (this enclosure requires the B12 mounting plate)

Installing the enclosure:

1. Remove any knockouts prior to installing the module.
2. Mount the enclosure in the desired location. Use all enclosure mounting holes. Refer to the mounting instructions supplied with the selected enclosure.
3. Pull any necessary wires/phone lines into the enclosure.

**Notice!**

Electromagnetic interference (EMI) can cause problems on long wire runs.

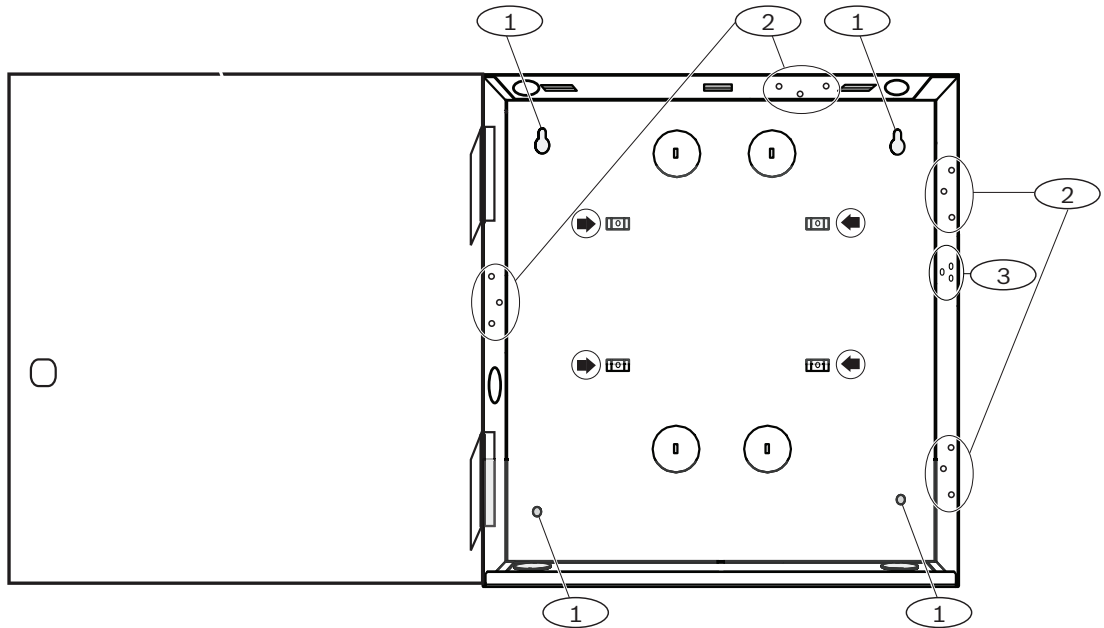

Figure 4.2: Enclosure mounting (B10 shown)

Callout — Description
1 — Enclosure mounting holes (4)
2 — 3-hole mounting locations (3)*
3 — Tamper switch mounting locations
*Use the upper, right-hand 3-hole mounting location for installing the optional B46 module in the enclosure so it lines up with the enclosure door hole.

4.3

Insert wiring label

Apply the supplied wiring label onto the inside of the enclosure door. Refer to the following figure.

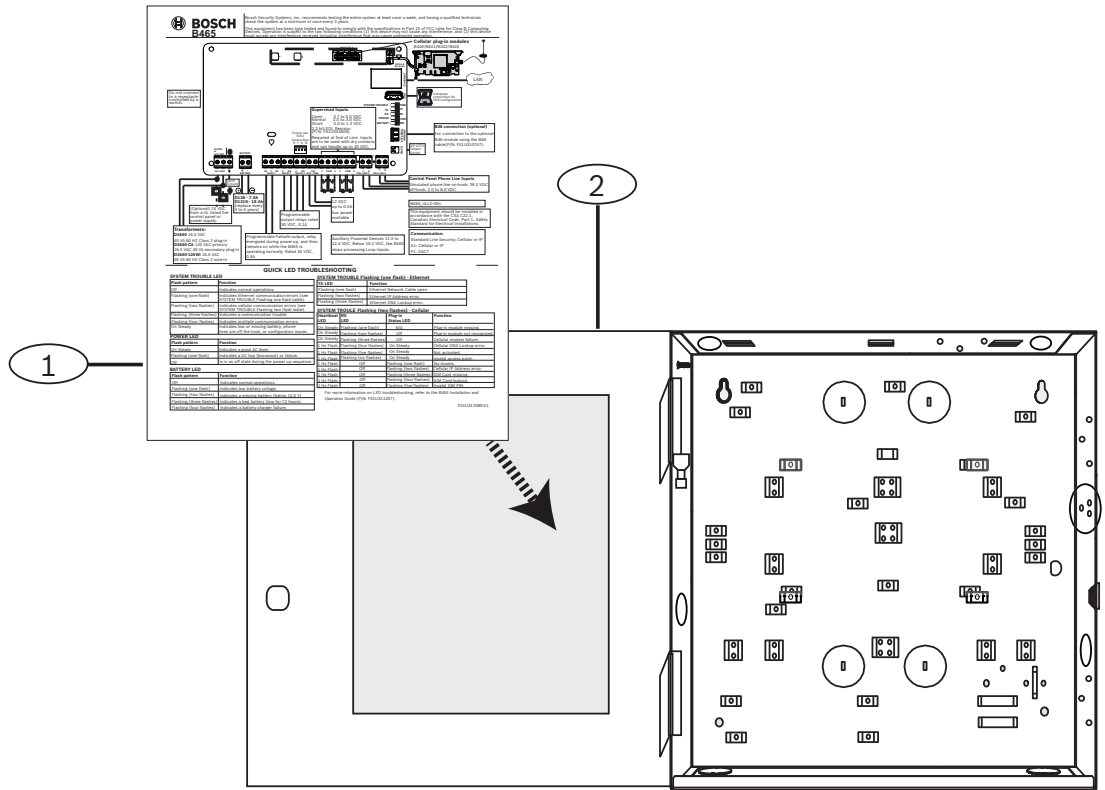

Figure 4.3: Applying the wiring label

Callout — Description
1 — Wiring label (supplied with the B465)
2 — Enclosure door (inside view)

4.4 Insert D101 lock (optional)

Refer to the instructions provided with the D101 for installation.



Notice!
The D101 lock is required for commercial fire installations.

4.5 Insert B46 LED cover (optional)

The B46 has an LED cover so that the user can view the main B465 LED status indications from outside the supported enclosure. Perform the following to insert the LED cover.
Installing the LED cover:

1. Locate the knockout area on the enclosure door. Refer to *Remove enclosure knockouts*, page 16.

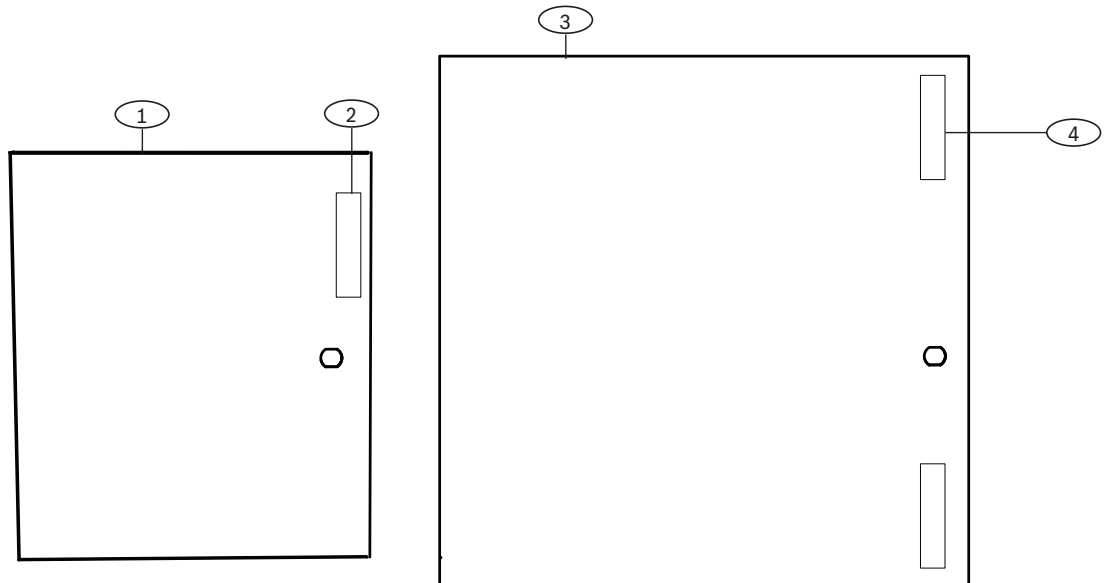

Figure 4.4: Knock-out locations (B10/B10R/D8103 shown)

Callout — Description
1 — B10/B10R
2 — Knockout location
3 — D8103
4 — Knockout location

2. Insert the plastic LED cover into the knockout area of the enclosure door. Refer to the following figure.

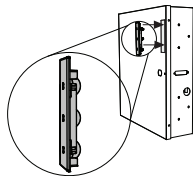

Figure 4.5: LED cover insertion

3. Snap the cover into place.
 4. Verify that the cover is secure.
- Cover installation is complete!

4.6 Install the module

Perform the following to install the module.



Warning!

The module is static sensitive. Touch earth ground before handling the circuit board to discharge any static electricity from your body. Use a grounding strap while installing the circuit board.

4.6.1 Mount the module

Identify the B465 mounting location in the enclosure before you begin mounting the module.

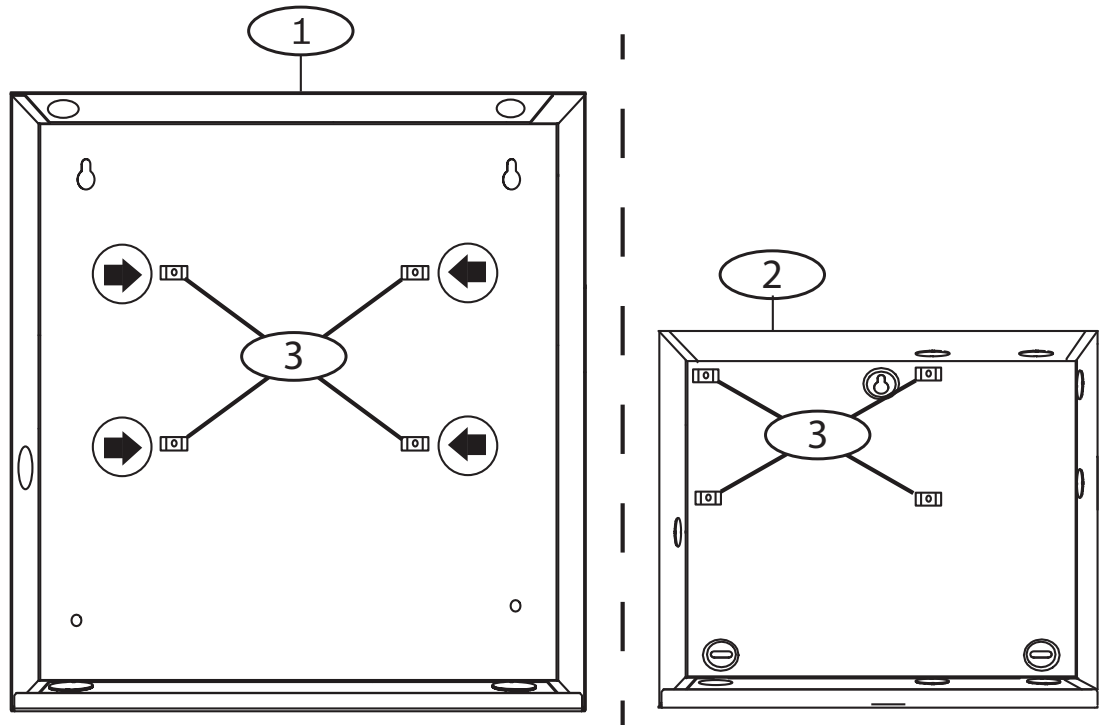

Figure 4.6: B10 and B11 mounting, wiring, and control panel placement locations

Callout — Description
1 — B10R Medium Control Panel Enclosure (Red)/B10 Medium Control Panel Enclosure
2 — B11R Small Control Panel Enclosure (Red)/B11 Small Control Panel Enclosure
3 — Mounting clip locations for the B465 Conettix Universal Dual Path Communicator

1. Snap the four supplied plastic standoffs onto four enclosure support posts.

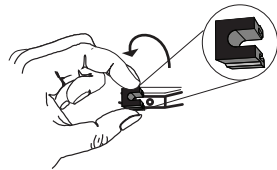

Figure 4.7: Inserting plastic standoff onto enclosure posts

2. Place the module on top of the standoffs. Align the holes in the corners of the module with the openings at the top of each standoff. Secure the module to the standoffs with supplied, self-threading screws.

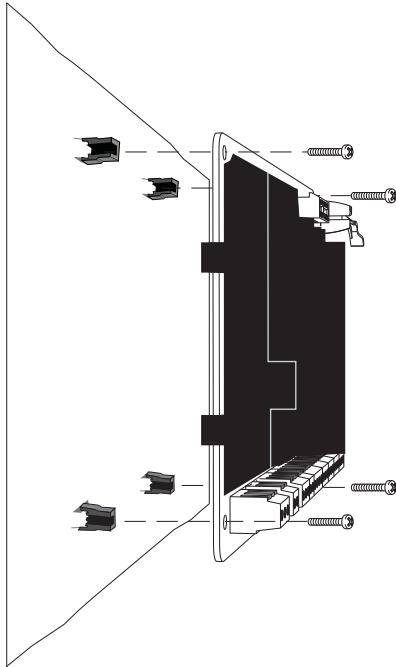

Figure 4.8: Mounting B465 on standoffs

D8103 installation

Refer to the B12 *Mounting Plate Installation Instructions* (P/N: F01U262949) for installing the required B12 mounting plate if in the D8103 Universal enclosure, or D8108A Attack Resistant Enclosures. Use the included hardware to install the B465 to the B12 Mounting Plate.

4.6.2

Mount the B46 (optional)

The B46 is an optional module which provides LED status from the B465. The B46 cover mounts externally to the enclosure door and is installed internally inside the enclosure.



Notice!

The B46 is required when the FACP is not able to indicate B465 troubles locally

Mount the module into the enclosure's 3-hole mounting pattern using the supplied mounting screws and mounting bracket. Refer to the figure below.

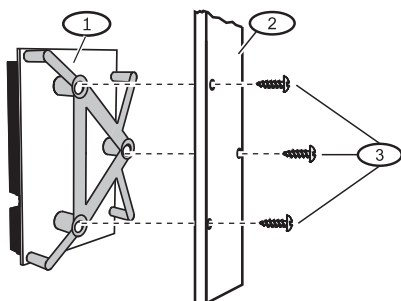

Figure 4.9: B46 mounting into B10 enclosure

Callout — Description
1 — Module with mounting bracket installed
2 — Enclosure
3 — Mounting screws (3)

Refer to the figure below for B46 enclosure mounting locations.



Notice!

Install the B46 in the upper, right-hand corner of the enclosure as shown in the following figure.

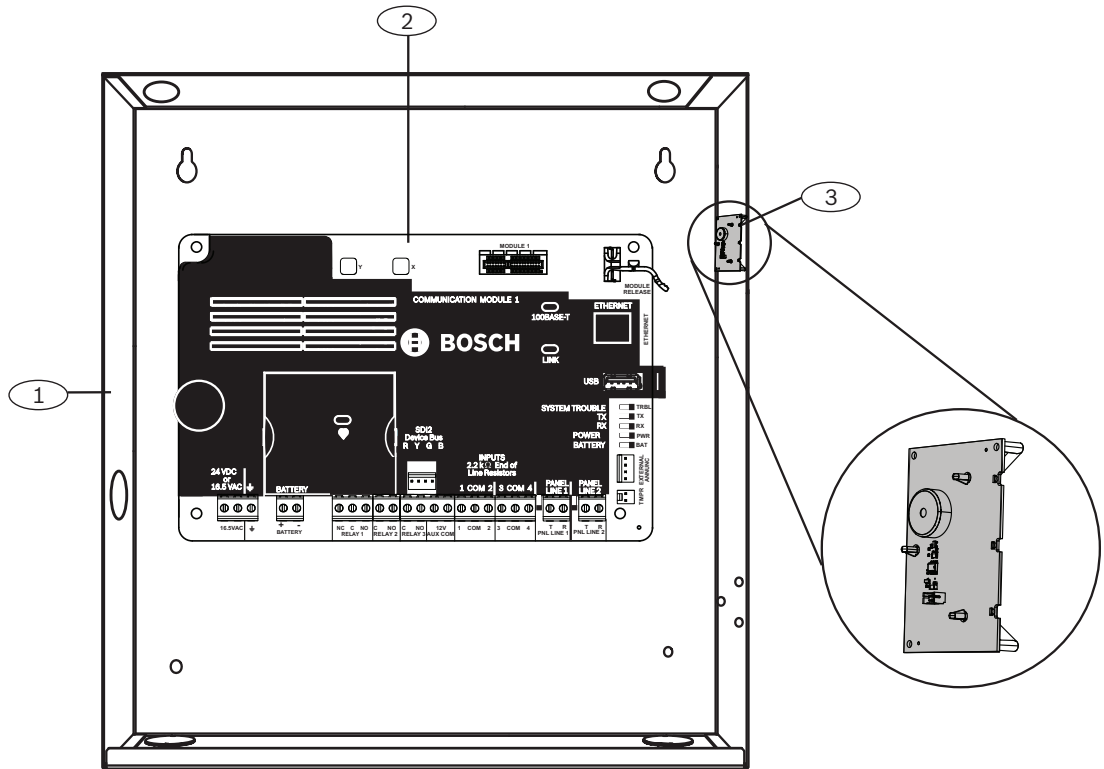

Figure 4.10: Mounting the B46 into an enclosure

Callout	Description
1	Enclosure (B10/B10R shown)
2	B465 module
3	B46 module

4.6.3 Connect earth ground

To help prevent damage from electrostatic discharges or other transient electrical surges, connect the system to earth ground before making other connections. The ⚡ icon indicates the earth ground terminal. Use a recommended earth ground reference, such as a grounding rod or a metal cold water pipe. Make the connection using 14 AWG (1.8 mm) to 16 AWG (1.5 mm) wire.



Notice!

Do not use telephone or electrical ground for the earth ground connection. Do not connect other control panel terminals to earth ground.



Caution!

Avoid electrostatic discharge. Always touch the earth ground connection with the ⚡ icon first, before beginning work on the control panel.



Notice!

In ground fault enabled systems, you might cause a ground fault when connecting a computer to the B465 for programming.

4.7 Insert the cellular communication module (optional)

Insert the desired B44x communication module into the slot of the module until you feel the module “click” into place.

For cellular communication, use one of the following:

- B440 Conettix Plug-in Cellular Communicator (3G Verizon – US only)
- B441 Conettix Plug-in Cellular Communicator (Verizon – US only)
- B442 Conettix Plug-in GPRS Cellular Communicator (outside the USA where approved)
- B443 Conettix Plug-in HSPA+ Cellular Communicator (where approved)

Install the cellular module

1. Power down the B465.
2. Insert the communication module into the stabilizing plug-in holes and plug-in module connector as shown in callouts #2 and 3 in *Module overview, page 9*.
3. Connect the antenna to the module by screwing onto the threaded connector.
4. Route the antenna cable through a wire knockout in the top of the enclosure.
5. Secure the antenna cable to the outside of the enclosure.



Notice!

If you experience a weak signal, place the antenna on top of a metal surface that has a radius of 10.16 cm (4 in) or larger for optimal performance.

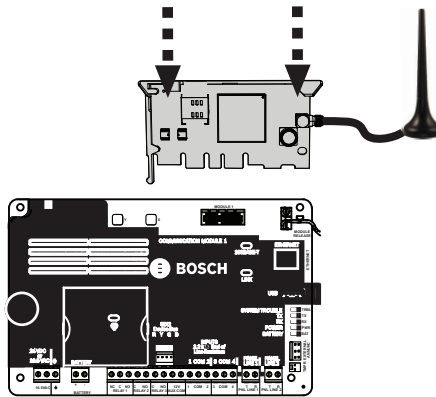

Figure 4.11: Cellular plug-in module insertion

4.8 Wiring installation

Refer to the following sections for detailed wiring information.

4.8.1 System wiring

You can use the B465 with a variety of intrusion and fire control panels that support the B465’s compatible protocols.

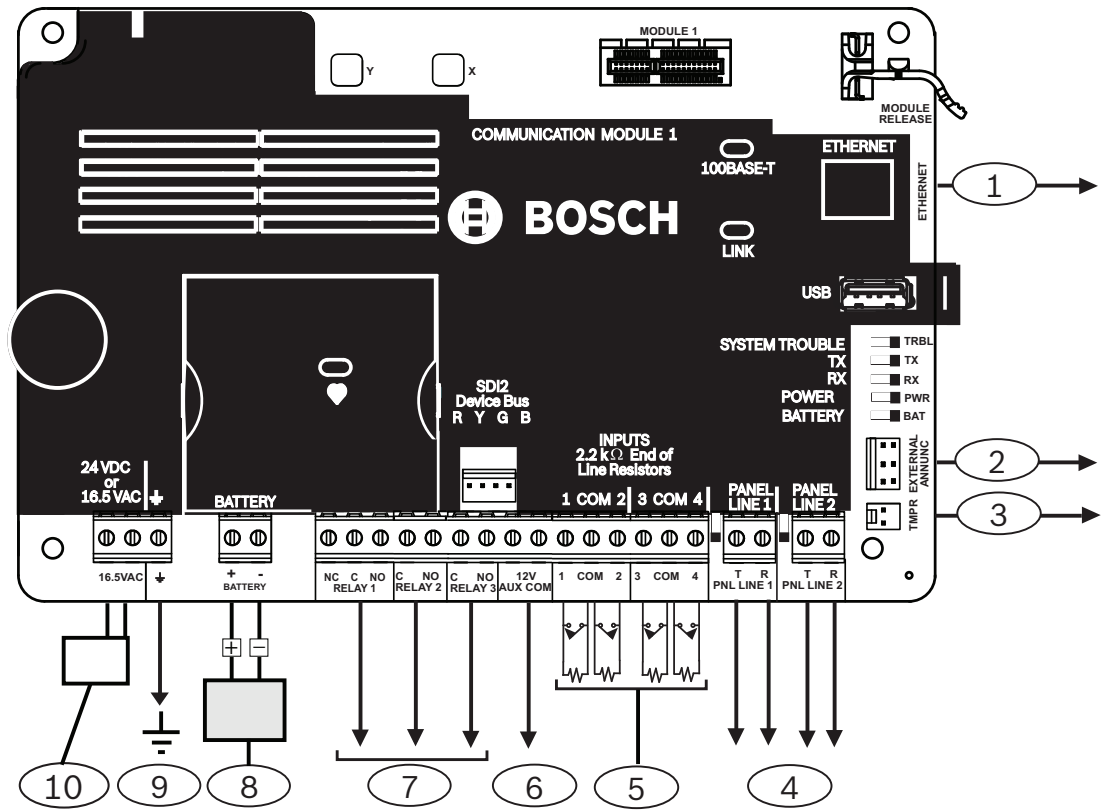

Figure 4.12: System wiring

Callout — Description	Callout — Description
1 — RJ-45 modular jack for Ethernet IP communications (optional)	6 — 12V AUX/COM terminals (optional output power source, Special Application 9.9 – 13.8 V)
2 — Connector for External Annunciator (connected to optional B46)	7 — Programmable output relays (Relay 1, Relay 2, Relay 3)
3 — To tamper switch	8 — 12 VDC lead-acid battery (7-18 Ah)
4 — Phone Line 1/2 (to control panel terminals if required)	9 — To earth ground
5 — Four EOL input loops	10 — D1640 plug-in transformer, D1640-CA plug-in transformer, D1640-120WI wired-in transformer or optional 24 VDC from a UL listed fire control panel or power supply.



Notice!

For Ground Fault detection, a wire must be run between AUX – (internal common ground, not earth ground) of both the FACP and the B465.

Wiring to a SDI2 device

The SDI2 Device Bus terminal connector is designed for future use.



Notice!

The SDI2 Device Bus terminal connector has not been tested by UL.

4.8.2

Control panel to dialer capture wiring

Use the correct wire gauge when connecting a B465 to an intrusion/fire control panel terminals (14-24AWG). Refer to the following figure for wiring information.

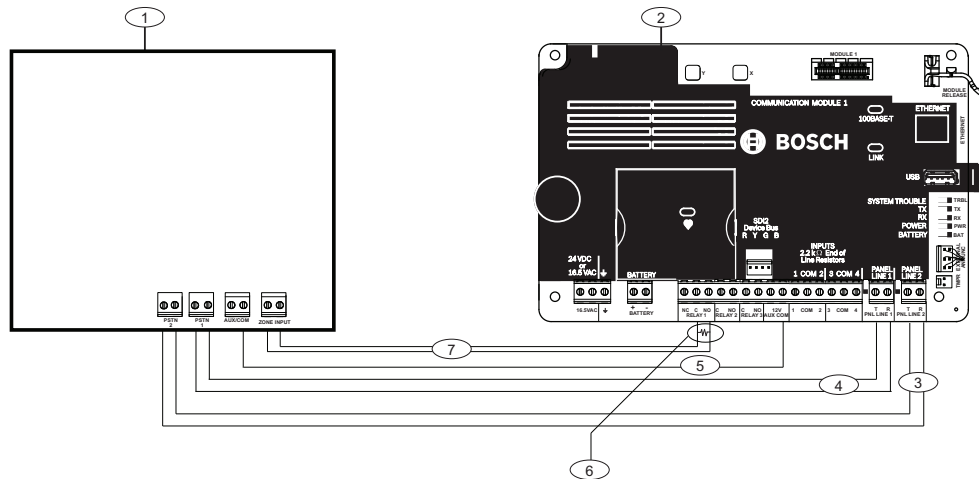

Figure 4.13: Panel to dialer capture wiring

Callout — Description
1 — Fire/intrusion control panel
2 — B465
3 — Optional second panel phone connection depending on equipment
4 — Primary phone connection
5 — Internal Ground (AUX Power negative or internal Common) required for Commercial Fire
6 — Control panel EOL resistor (required for supervision with callout #7)
7 — Optional for local B465 troubles

4.8.3

Control panel to dry contact wiring

Use the correct wire gauge when connecting a B465 to an intrusion/fire control panel terminals (14-24AWG). Refer to the following figure for wiring information.

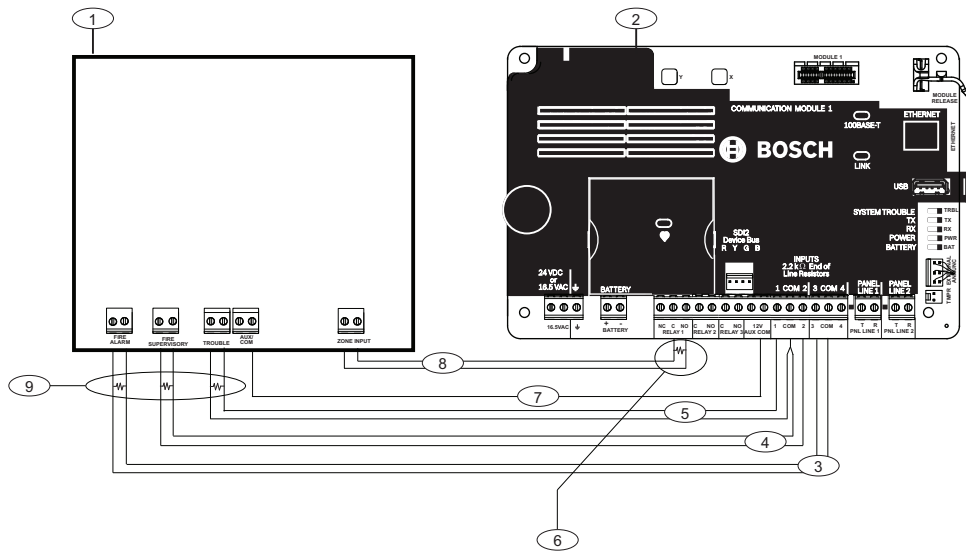

Figure 4.14: Panel to dry contact wiring

Callout	Description
1	Fire/intrusion control panel
2	B465
3	Fire alarm connection
4	Fire supervisory connection
5	Trouble (AC Fail, Low Battery, etc)
6	Control panel EOL resistor (required for supervision with callout #8)
7	Internal Ground (AUX power negative or internal Common) required for Commercial Fire
8	Optional panel inputs for B465 troubles
9	B465 EOL resistors

4.8.4

B46 module wiring (optional)

Use the cable supplied with the B46 to connect to the B465 module. Refer to *System overview*, page 9 section for component location. Refer to the figure below.

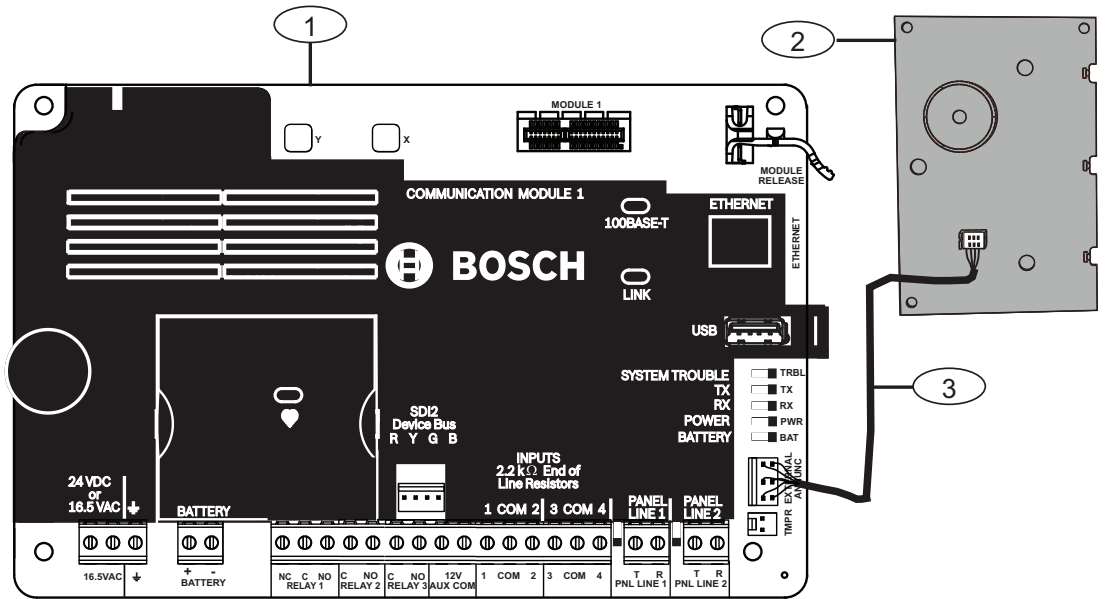

Figure 4.15: B46 cable connection

Callout — Description
1 — B465 module
2 — B46
3 — B46 Cable (P/N: F01U310747) included with the B46



Notice!

The white wires of the B46 cable should be facing the words “EXTERNAL ANNUNCIATOR.”



Notice!

Ensure the placement of the B46 cable does not obstruct the LEDs of the B465 when inserting into the port of the B465.

4.8.5

Input loop wiring

The B465 provides four on-board inputs. Each input functions independently and does not interfere with the operation of the others. The module monitors the input loops for normal, shorted, or open conditions between an input terminal and any of the input common terminals.

The programming for the input determines how the module responds to these conditions. The module ignores input loops for 120 seconds after power up to ensure that the connections have stabilized.

Input loops

Install a 2.21 kΩ resistor at the far end of the input loop when wiring the on-board inputs to provide a reference for supervision. The total resistance for the wire length and contacts, minus the end-of-line (EOL) resistor, must not exceed 100 Ω.

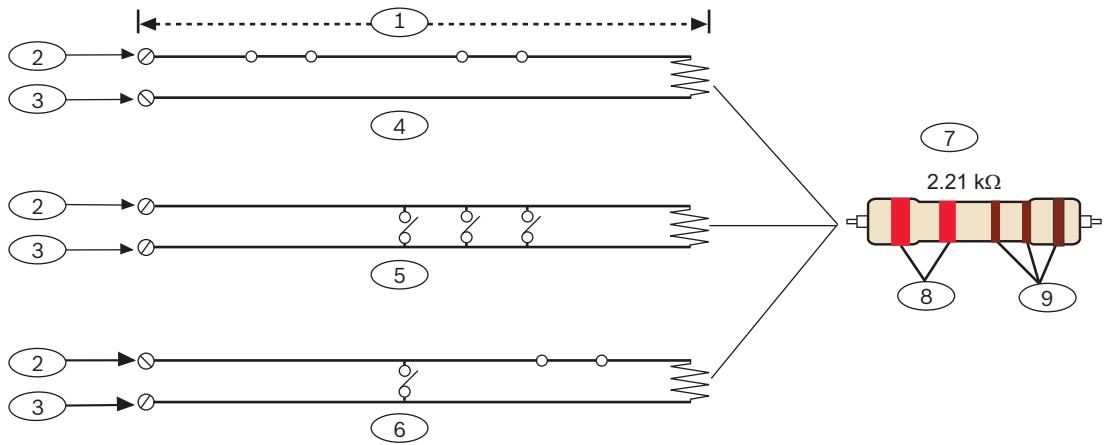

Figure 4.16: On-board input loop wiring

Callout	Description
1	100 Ω maximum (total wire out and back)
2	Input terminal
3	Common
4	Normally closed contacts (NC)
5	Normally open contacts (NO)
6	Combination: Normally open contacts and normally closed contacts (NO/NC)
7	2.21 kΩ EOL resistor (P/N: F01U034506)
8	Red
9	Brown



Notice!

You do not need to install the End of Line (EOL) resistor for unused inputs (inputs are disabled by default).

UL does not permit normally closed loops for commercial fire applications.

Input voltage parameters

You can determine the condition of on-board inputs 1 to 4 by measuring the voltage across the input terminal (1 to 4) and the point COM terminal. The loop wiring must be connected and the 2.21 kΩ EOL resistor must be in place and the input function programmed.

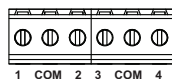

Figure 4.17: Input terminals

Loop	Voltage range
Open	Greater than 3.7 VDC, but less than 5.0 VDC
Normal	Greater than 2.0 VDC, but less than 3.0 VDC
Shorted	Greater than 0.0 VDC, but less than 1.3 VDC

Table 4.1: Input voltage parameters



Warning!

UL Commercial Fire applications do not allow multiple wires to be installed in any terminals on the B465. If multiple wires are required then a single wire to the terminal is to be used and the multiple wires would be combined with the single wire using a wire nut or other approved method.

The graphic below is an example of an multiple wire connections to a terminal.

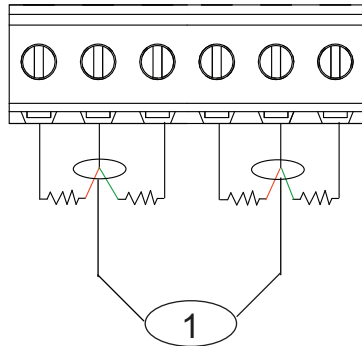

Figure 4.18: Multiple wire connections to a terminal example

Callout — Description
1 — Wire nut or other means required to tie wires together as UL only allows one wire in each terminal.

4.8.6

Output wiring

The module has three programmable relay outputs that can optionally be connected to a supporting control panel’s zone or point inputs. The three outputs consist of:

- RELAY 1
- RELAY 2
- RELAY 3

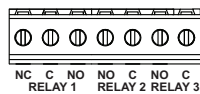

RELAY 1

RELAY 1 is active (energized) once the B465 is running. If the B465 detect a problem or loses power, RELAY 1 de-energizes, which can be used to indicate a system trouble on the local control panel's zone inputs, if required. Depending on the configuration required to create a

system trouble on the control panel, the installer needs to use either the NO and COM or the NC and COM connections. Refer to the control panel manual for the required zone configuration to obtain the proper input response.

RELAY 2

RELAY 2 is a normally open (NO) relay with contacts that close when the desired function programmed is detected.

RELAY 3

RELAY 3 is a normally open (NO) relay with contacts that close when the desired function programmed is detected.

4.8.7**Input power supply wiring**

The B465 uses an AC transformer or DC voltage for its primary power source. The approved transformers are the D1640 plug-in transformer, D1640-CA plug-in transformer, or the D1640-120WI wire-in transformer. The B465 can optionally be powered from 24 VDC power source applied to the AC terminals.

Earth ground connection

Transient suppressors and spark gaps protect the circuit from power surges. This protection relies on the ground connection at the earth ground terminal, marked with the earth ground icon. Ensure that you connect the terminal to a proper ground.

Input power supervision

The system can be configured to operate from either an AC or DC input power source. By default the B465 is setup for AC operation.

AC operation

The system indicates an AC power failure when the 16.5 VAC terminals does not detect enough AC voltage to maintain the system when the input power source is set to AC. The Input power fail delay parameter sets the number of minutes without power before the B465 reports the failure, The same parameter is used when power returns before the B465 reports power restored. For example, if the input power fail delay time is set to 60 minutes, the Input Power Fail Delay option does not send a report until the power has failed for 60 minutes. The restore report is sent 60 minutes after power restores.

DC operation

When the input power source is set to DC, the system indicates a DC power failure when the 16.5 VAC terminals does not detect enough DC voltage to maintain the system. The Input power fail delay parameter sets the number of minutes without power before the B465 reports the failure, The same parameter is used when power returns before the B465 reports power restored. For example, if the input power fail delay time is set to 3 minutes, the Input Power Fail Delay option does not send a report until the power has failed for 3 minutes. The restore report is sent 3 minutes after power restores.

The following figure shows an optional 24 VDC wiring connect from a UL listed 24 VDC fire control panel into the 24 VDC or 16.5 VAC terminal.

When using 24 VDC, the negative voltage lead should be installed on the leftmost pin, with the positive voltage lead installed between the negative lead and the earth ground terminal.

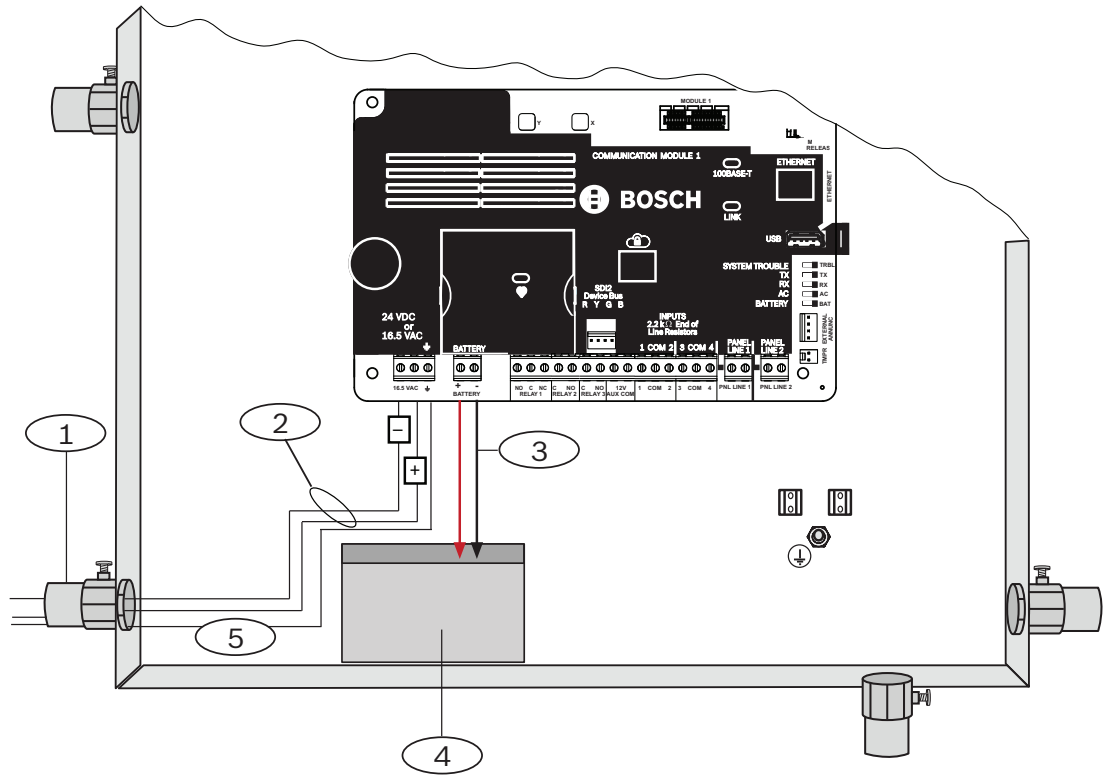

Figure 4.19: 24VDC wiring to a UL Listed fire control panel or UL Listed power supply

Callout — Description
1 — Conduit required for use with external wiring
2 — 24 VDC from UL Listed fire control panel wiring or UL Listed power supply wiring
3 — Batteries wires (red and black)
4 — 12 V, 7-18 Ah sealed lead-acid rechargeable battery (D126/D1218)
5 — B465 ground wire connection



Notice!

24VDC input is polarity sensitive. If you connect the DC in the opposite direct the B465 will run but it will indicate a input power failure.



Notice!

Do not wire 16.5 VAC and 24 VDC at the same time. Doing so will damage the module, the transformer, and/or the 24 VDC power supply.

Self diagnostics at power up and reset

The system performs a series of self-diagnostic tests of hardware, software, and programming at power up and at reset. The self-diagnostics tests complete in approximately 10 to 30 seconds. If the B465 fails any test, a System Trouble occurs. Trouble LED's turn on or relay outputs will activate depending on configuration.

Install the transformer**Caution!**

Do not short-circuit the terminals of the plug-in transformer: Shorting the terminals opens the internal fuse, causing permanent failure. Connect the plug-in transformer to the 16.5 VAC terminals of the B465 before plugging it into the power source.

**Notice!**

Plan ahead

Route telephone and input loop wiring away from any AC conductors, including the transformer wire. AC wiring can induce noise and low level voltage into adjacent wiring.

1. Use 18 AWG (1.02 mm) wire minimum (12 AWG [2 mm] maximum) to connect the transformer to the control panel. Make the wire length as short as possible. Do not exceed 50 ft (15 m). maximum wire resistance should not exceed 0.65 ohms.
2. Connect the wire to the control panel.
3. Connect the wire to the transformer.
4. Plug the transformer into an unswitched, 120 VAC, 60 Hz power outlet only.
5. Secure the transformer to the outlet with the screw provided.

**Notice!**

A D8004 Transformer Enclosure is required for Commercial Fire applications if you are using either the D1640 or D1640-CA plug-in transformers.

4.8.8**D1640-120WI transformer wiring (optional)**

The D1640-120WI Transformer is a wired-in transformer that provides 16.5 VAC for the B465 and is installed in the B10 Medium Control Panel Enclosure/B10R Medium Control Panel Enclosure (Red) only.

4.8.9**12 VDC battery wiring**

A 12 VDC, 7-18 Ah sealed lead-acid rechargeable battery (D126/D1218 – supplied separately) supplies secondary power for auxiliary power output, and powers the system during interruptions in primary (AC or DC) power.

**Caution!**

Do not attach the 24 VDC to the battery terminals or you will permanently damage the B465.

**Notice!**

Use lead acid batteries only.

The charging circuit is calibrated for lead-acid batteries. Do not use gel-cell or nicad batteries.

D1218 Battery increase backup time

The D1218 is a 12 V, 18 Ah battery for use in applications requiring extended battery standby time. The module does not support more than 18 Ah.

Install the battery

1. Place the battery upright in the base of the enclosure.
2. Locate the red and black leads supplied within the packaging contents.
3. Connect the black battery lead to the BATTERY- terminal, and then to the negative (-) side of the battery.
4. Connect the red battery lead to the BATTERY+ terminal, and then to the positive (+) side of the battery.



Warning!

High current arcs are possible. The positive (red) battery lead and the BATTERY+ terminal can create high current arcs if shorted to other terminals or the enclosure. Use caution when working with the positive lead and BATTERY+. Always disconnect the positive (red) lead from the battery before removing it from BATTERY+.



Caution!

The battery + terminal and wire are not power limited. Maintain a 0.250 in (6.4 mm) space between the battery terminals, battery wiring, and all other wiring. Battery wiring cannot share the same conduit, conduit fittings, or conduit knockouts with other wiring.

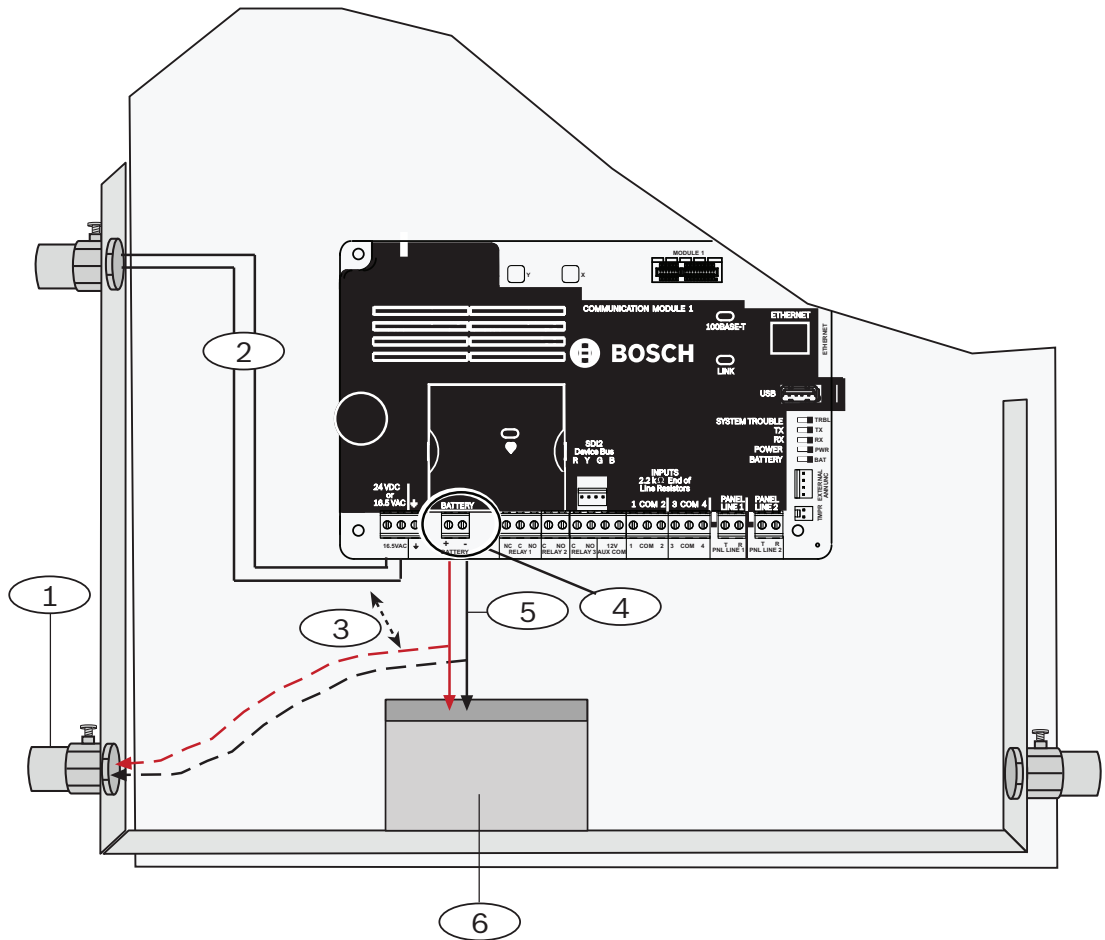

Figure 4.20: NON-power limited wiring for a plug-in transformer

Callout — Description
1 — Conduit required for use with external batteries
2 — D1640 UL Listed Class 2 Plug-in Transformer 16.5 VAC, 40 VA, 60 Hz
3 — 0.25 in (6.4 mm) minimum
4 — Battery terminals. BATTERY+ is non-power limited
5 — Battery wires (red and black)
6 — 12 VDC, 7-18 Ah sealed lead-acid rechargeable battery (D126/D1218)

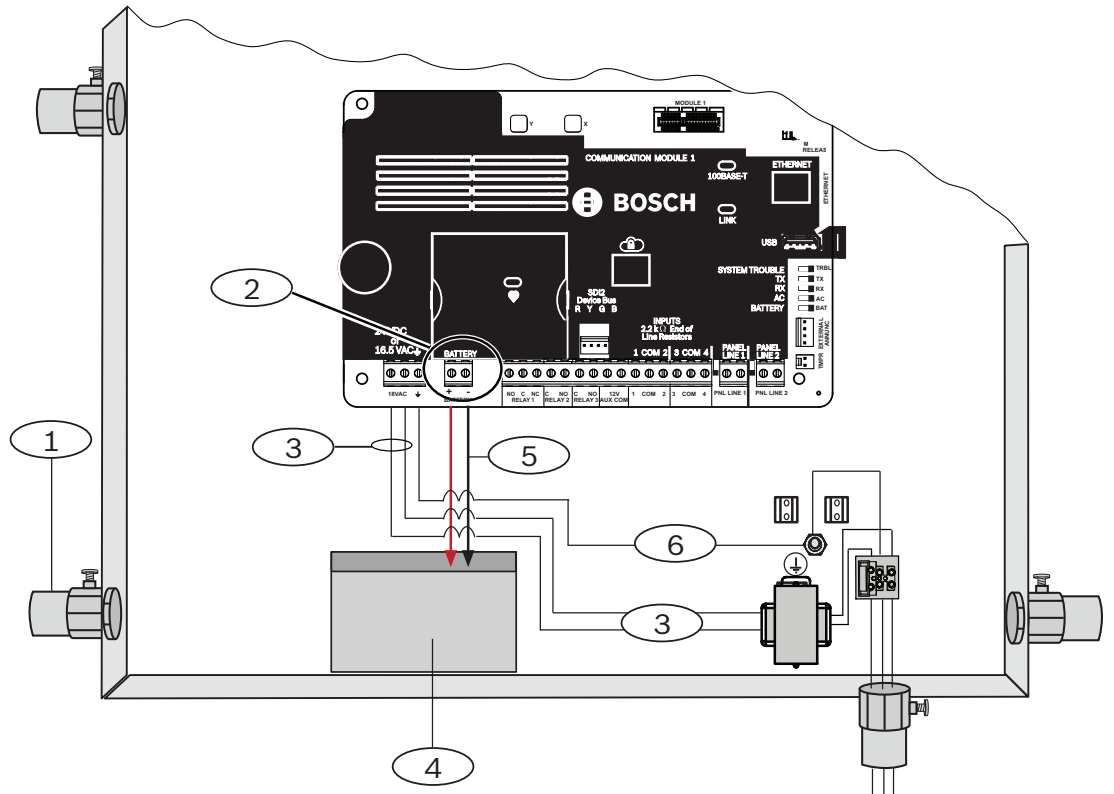

Figure 4.21: NON-power limited wiring for a wired transformer

Callout — Description
1 — Conduit required for use with external batteries
2 — Battery terminals. BATTERY+ is non-power limited
3 — D1640-120WI UL Listed Class 2 Wired Transformer 16.5 VAC, 40 VA, 60 Hz (tuck the wires behind the battery to ensure the proper clearance)
4 — 12 VDC sealed lead-acid rechargeable battery (D126/D1218)
5 — Battery wires (red and black)
6 — B465 ground wire connection (tuck the wires behind the battery to ensure the proper clearance)

Battery maintenance

Use sealed lead-acid rechargeable battery (12.0 VDC, 7 Ah to 12.0 VDC, 18 Ah). The B465 supports up to 18 Ah of battery. Replace the batteries every 3 to 5 years. Record the date of installation directly on the battery.



Caution!

Exceeding the maximum output ratings or installing the transformer in an outlet that is routinely switched off causes heavy discharges. Routine heavy discharges can lead to premature battery failure.

Battery lead supervision

The battery charging float level occurs at 13.65 VDC. If the battery voltage drops below 12.1 VDC, the B465 sends a LOW BATTERY report, and indicate a Low Battery on the LED if programmed to do so. The B465 (if programmed for battery supervision) sends a Battery Low report. It sends a Low System Battery (302) report in the Contact ID format. It also lights the LOW BATTERY LED.

If programmed for battery supervision, the B465 adds a missing battery event to the event log. If programmed for battery fault reports, the control panel sends a BATTERY MISSING report, or Control Panel Battery Missing (311) report in the Contact ID format.

When battery voltage returns to 13.4 V or higher, the B465 turns the LOW BATTERY LED off. If the B465 is programmed for battery supervision, it sends a BATTERY RESTORAL report, or a Control Panel Battery Restored to Normal (302) report in the Contact ID format.

Investigate LOW BATTERY events immediately: If primary (AC or DC) power is off and the discharge continues, the B465 becomes inoperative when the battery voltage drops below 10.2 VDC, and the battery cutoff relay deactivated.

Battery discharge and recharge schedule**Discharge cycle**

13.65 VDC - Charging float level.

12.1 VDC - Low Battery Report, if programmed.

10.2 VDC - Minimum operational voltage.

Recharge cycle

AC ON - Battery charging begins and AC Restoral Reports sent.

13.4 V - Battery Restoral Report sent. Battery float charged.

5 Communications

This section contains information on various communication topics related to the module.

**Notice!**

All messages generated internally by the B465 are sent to the central station using Contact ID with area 99 as the unique identifier for automation.

**Notice!**

It is recommended to use a different control panel and B465 account number if the control panel is not using Contact ID as the reporting format as this might cause problems in automation. Check with the central station first.

5.1 IP communication

The module uses the on-board Ethernet connector, and/or optional B440 Conettix Plug-in Communicator, Cellular (3G), B441 Conettix Plug-in CDMA Cellular Communicator, B442 Conettix Plug-in GPRS Cellular Communicator or B443 Conettix Plug-in HSPA+ Cellular Communicator to communicate with a Conettix D6600, Conettix D6100i or a Conettix D6100IPv6 Communications Receiver/Gateway. Using Conettix IP communication protocol offers a secure path that includes anti-replay/anti-substitution features and provides enhanced security with up to AES 256-bit encryption.

The module supports Domain Name System (DNS) for central station communication. DNS provides ease of use, eliminating the need to use static IP addresses as your reporting destination, and accommodates a simple solution for central station disaster recovery.

**Notice!**

The B442 is not a UL listed product.

5.1.1 On-board Ethernet connection

The built-in Ethernet port on the control panels allows for a network connection without the need for additional modules. The port supports both 10 Base-T (10 Mb) and 100 Base-TX (100 Mb) standards. The port supports full duplex, half duplex, and HP AUTO_MDIX communication, using a standard Ethernet cable.

Supervision

The B465 supervises its on-board Ethernet connection when it uses Ethernet to the receiver(s), if programmed as part of either the primary route or the backup route. Supervision ensures reliable operation of the entire Ethernet path from end to end. If the on-board Ethernet path does not respond to B465 supervision polls, then a system fault message appears on the LEDs. The B465 sends a corresponding report to the central station when programmed to do so. This is done using a second receiver, or over the optional cellular network if installed and programmed.

On-board Ethernet diagnostics LEDs

The B465 includes the following on-board LEDs to assist with troubleshooting the onboard Ethernet connection.

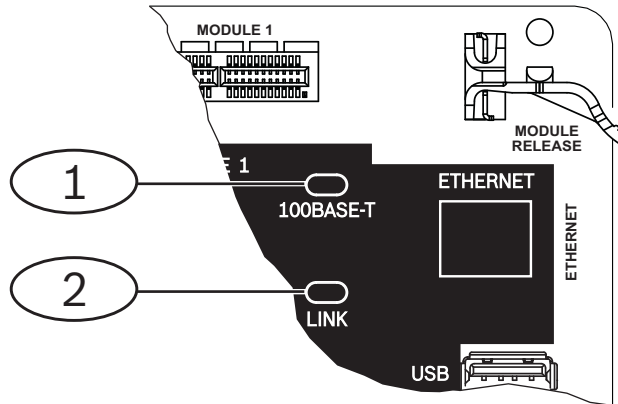

Figure 5.1: On-board Ethernet connector and LEDs

Callout	Description
1	100BASE-T LED (green)
2	LINK LED (yellow)

Refer to *LED status indicators*, page 75 for information on the 100BASE-T and LINK LEDs.

5.1.2

Conettix Plug-in Cellular Communicators

Cellular plug-in communicators provide communication between the control panel and central monitoring stations using a cellular network. The B465 supports one plug-in cellular module.

Supervision

The B465 supervises the plug-in cellular communicator when the B465 uses the communicator to the receiver(s), if programmed, as part of either the primary route or the backup route. Supervision ensures reliable operation of the entire cellular path from end to end. If the cellular path does not respond to B465 supervision polls, then a system fault message shows on the LEDs. The B465 sends a corresponding report to the central station when programmed, using a second receiver or over the Ethernet if programmed.

Signal strength and diagnostics LEDs

Five LED patterns indicate that you correctly secured the module in the B465 plug-in slot and indicate the signal strength obtained by the module. Refer to *LED status indicators*, page 75, Conettix Plug-in cellular module LEDs for more information on cellular module LEDs.

5.1.3

Compatible receivers for IP communication

Sending Conettix IP reports requires a Bosch central station receiver. The following receivers are compatible with B465:

- Conettix D6600 Communications Receiver/Gateway
- Conettix D6100IPv6 Communications Receiver/Gateway
- Conettix D6100i Communications Receiver/Gateway

Central Station information

Perform the following:

1. Verify the receiver is configured in NNC mode.
2. Select Integrated Device as the Network Device for the B465.
3. Enter the same NNC number that was generated in the B465.
4. Select the same supervision time as selected in the B465.

5.1.4 Communication routing

The B465 provides a variety of ways in which communication to the central station can occur. Several configurations are available, depending on your configuration and the number of receivers connected to at the central station. Various configuration options include connecting to one or two central station receivers and/or the use of one or two routing technologies (Cellular or Ethernet). Refer to the examples below for a configuration that resembles your need.

Example 1: One receiver and one routing technology

In the *Standard Communication Configuration Menu, the number of receivers is set to one, and you are using one routing technology (either Cellular or Ethernet). You are routing communication to one central station receiver using one type of technology.

Example 2: One receiver and two routing technologies

In the *Standard Communication Configuration Menu, the number of receivers is set to one. You are using two routing technologies (Cellular and Ethernet), and your receiver is configured to receive both routing technologies (Cellular and Ethernet). Doing so allows you to configure the B465 so that if one technology fails, the B465 automatically switches over to the other technology in order to maintain communication with the central station receiver. Routing is switched after two call attempts. For example, you might select Cellular as your primary routing technology to the central station receiver, and have Ethernet as your “back-up” routing technology. This would be useful in a situation where the B465 loses communication with the central station receiver due to a power outage in one of the cellular towers. The B465 automatically switches over to Ethernet, maintaining the communication link to the central station.

Example 3: Two receivers and one routing technology

In the Advanced Communication Configuration Menu, the number of receivers is set to two. You are using one routing technology (either Cellular or Ethernet), and both receivers are configured to receive the same routing technology (either Cellular or Ethernet). Doing so allows you to configure the B465 so that if one receiver fails, the B465 automatically switches over to the other receiver in order to maintain communication with the central station receiver. Routing is switched to receiver 2 after two call attempts. This would be useful in a situation where one central station receiver might have a hardware failure, or is down for maintenance. The B465 automatically switches over to the other receiver, maintaining the communication link to the central station.

Example 4: Two receivers and two routing technologies

In the Advanced Communication Configuration Menu, the number of receivers is set to two. You are using two routing technologies (Cellular and Ethernet), and both receivers are configured to receive the same routing technologies (Cellular and Ethernet). Doing so allows you to configure the B465 so that if one routing technology fails at receiver 1, another attempt at communication occurs using the other routing technology. Routing will automatically switch over to the second receiver if communication fails on receiver 1 during the second attempt to establish communication, using the alternate routing technology. When the routing is switched to the second receiver, a one call attempt is made using the primary routing technology. If communication is not established, then a one call attempt is made on the second receiver using the alternate routing technology. If communication is not established after this attempt, a troubled condition is sent to your B465.

*If Encryption is required, then programming under the Advanced Communication Configuration menu is required.

Refer to the figure below for examples of two supervised IP channel paths.

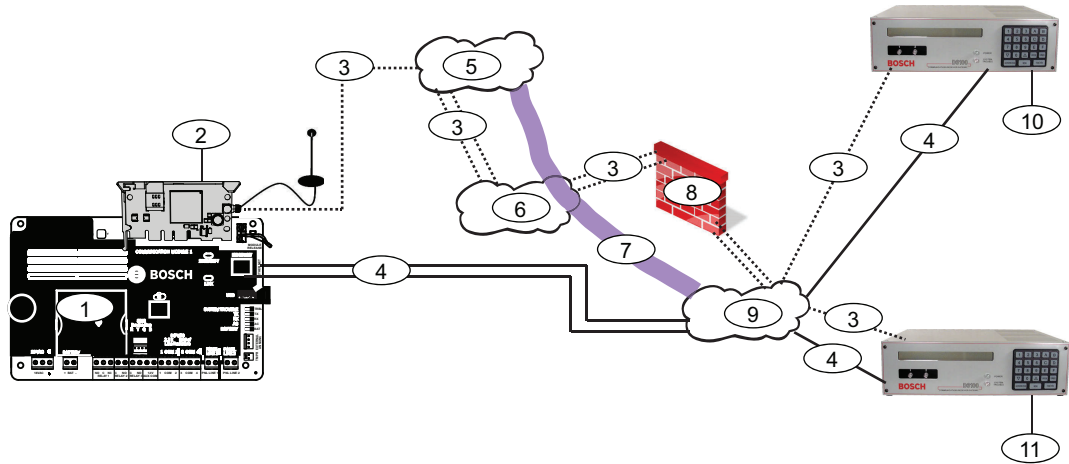

Figure 5.2: Cellular connection overview

Callout — Description
1 — B465 module
2 — Supported cellular communication module
3 — Cellular connection
4 — Ethernet connection
5 — Cellular Carrier
6 — Internet
7 — Optional VPN tunnel
8 — Router firewall
9 — Corporate network
10 — Primary Conettix receiver
11 — Secondary Conettix receiver

Notice!

NFPA Fire Application Note

Cellular sole path communications with supplementary Ethernet communications.



When cellular communications is configured under NFPA 72 (2010 – 2016) requirements for a single communication technology, Ethernet can be used as a supplementary communication path without requiring the secondary power capacity requirements on the protected premise network equipment, where acceptable to the authority having jurisdiction. This makes it possible for fire signals to be transmitted over Ethernet to the central monitoring station when cellular communications are disrupted.

6 Configuration

You can configure the B465 using the method described in this section.

You must install a serial communication program prior to configuring your system when using the USB option. Doing so establishes communication between the B465 module and a computer through the use of the USB cable and supporting software. Refer to *Install a serial communication program, page 44* to install the Tera Term communication program.

**Notice!**

Power up the system prior to the configuration workflows described in this chapter.

**Notice!**

On first power up, the phone line voltage will not present until the preferred network technology (Ethernet or Cellular) has established a connection. The preferred network technology is defaulted to Ethernet so if an active network connection is not detected, the simulated phone voltage would not be applied to satisfy the phone line monitor of the connected control panel. The same applies to the Cellular interface if it is used until the module is active and the preferred network technology has been programmed to Cellular.

6.1 Use USB to configure the B465

You can use a USB connection from a laptop PC to the B465 to configure the B465 on-site. The supported USB cable used to establish connection is a Male A to Male A cable.

**Notice!**

Use a Bosch supported USB cable such as the B99 cable (F01U278853). Failure to do so may result in communication failures between the B465 and your computer.

**Notice!**

USB connection is for configuration or diagnostics only. Disconnect when done.

Before you can access the USB user interface, you must install or browse to the RB_B465.inf file on the target PC or laptop. The B465 USB driver (RB_B465.inf) file is available on the supplied user CD. You need to install this file only once on the target computer.

Installing the driver from the web:

1. From your Internet browser, go to: <http://www.boschsecurity.com> to open the Bosch Web site.
2. Select the web site for your region and country.
3. In the Online Catalogs section on the left, click the Intrusion Alarm Systems link.
4. Under the Intrusion Alarm Systems Products heading, scroll to the Conettix - Information Transport Solutions section. Click the Show product section link.
5. Click the Conettix IP link.
6. Scroll to the B465 Conettix Universal Dual Path Communicator section. Click the section title to open the product page.
7. Under the product image, click the Software tab.
8. Click OK to accept the license agreement.

9. To the right of the B465 , click on the language link (for example, en).
The File Download dialog box opens.
10. Click Save to save the file to the target computer. Perform this task to download the B465 USB driver file (RB_B465.inf file and rb_b465.cat files).
11. Supply power to the B465.
12. Connect the B465 to the target computer, using a USB Type A to A cable. A New Hardware Found window appears on the computer.
13. Browse to install the RB_B465.inf file found under the new hardware found on your computer. Verify through the device manager that the appropriate .inf installs properly, and is listed under the Ports (COMM & LPT) section. The correct .inf file is B465 Dual Path Communicator.
14. Install a communication program to configure the B465.

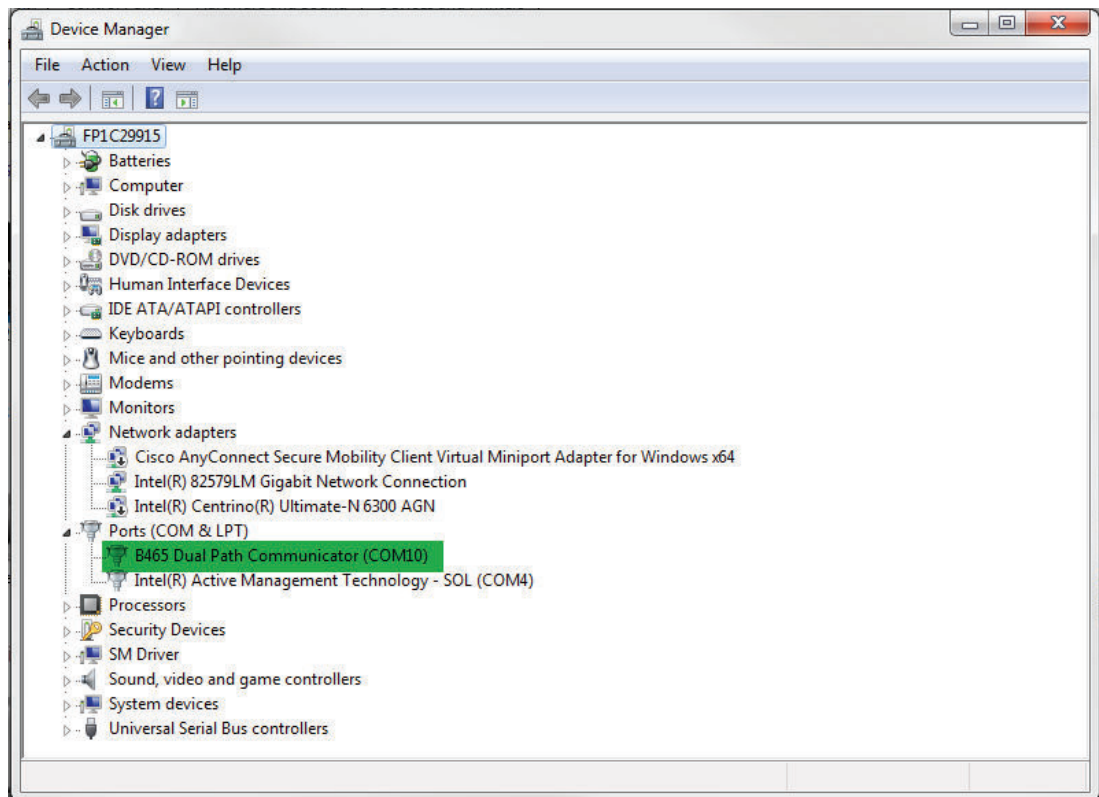

Figure 6.1: RB_B465.inf installed inside Device Manager

6.2 Install a serial communication program

Install a serial communication program to establish communication from a computer to the B465.

For your information

- Windows Vista and Windows 10/8/7 installations no longer include a serial communication program when the operating system installs. Install Tera Term from the B465 user CD.
- Windows XP. The Microsoft Windows XP installation automatically installs HyperTerminal, a Microsoft serial communication program, when Windows installs. If HyperTerminal is not installed, install it from the Windows XP installation disc, or install Tera Term from the B465 user CD.

Install the serial communication program that supports your configuration (Hyper Terminal or Tera Term), depending on your computer's operating system.



Notice!

Tera Term is preferred in all applications as its operation is understood by Bosch Technical Support if assistance is required.

Installing Tera Term

When you perform the Tera Term installation, follow the prompts in the installation wizard, but on the Select Components page of the wizard, select **Compact installation** from the drop-down list. Refer to the figure below.

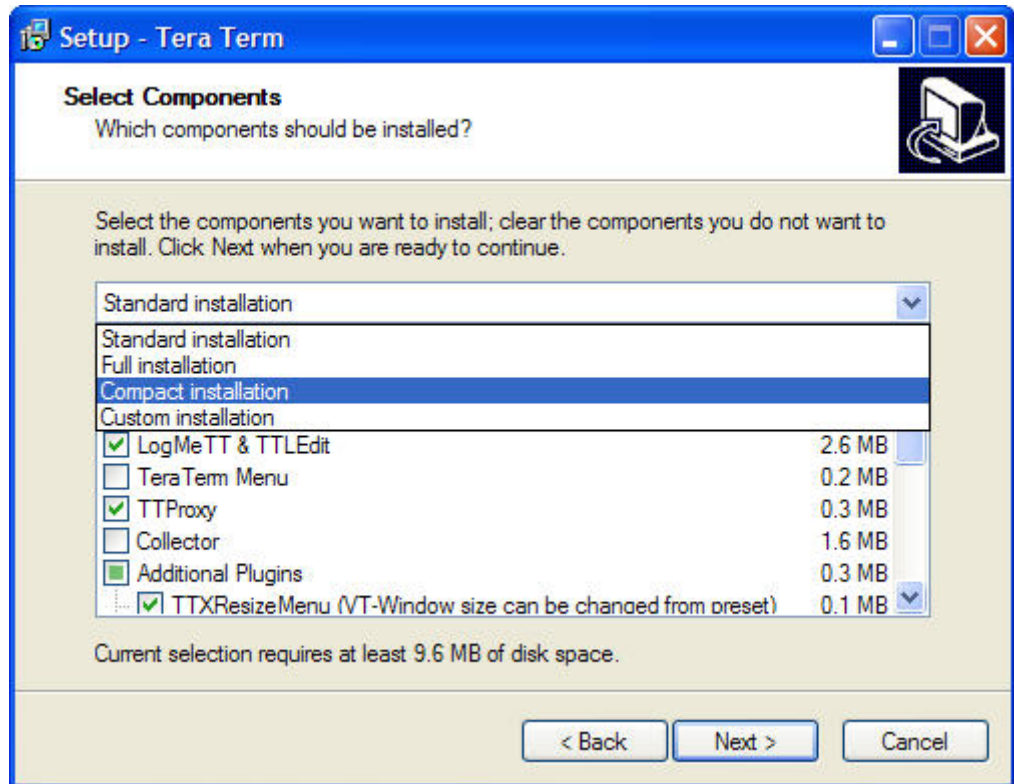

Figure 6.2: Setup - Tera Term wizard's Select Components window

Tera Term version interface

After installing the latest Tera Term version, double-click on Tera Term to launch the program. The Tera Term window opens. Refer to the illustrations below to set up Tera Term defaults.

Setting up Tera Term defaults:

1. Launch the application.
2. Click Setup => Terminal as shown below.

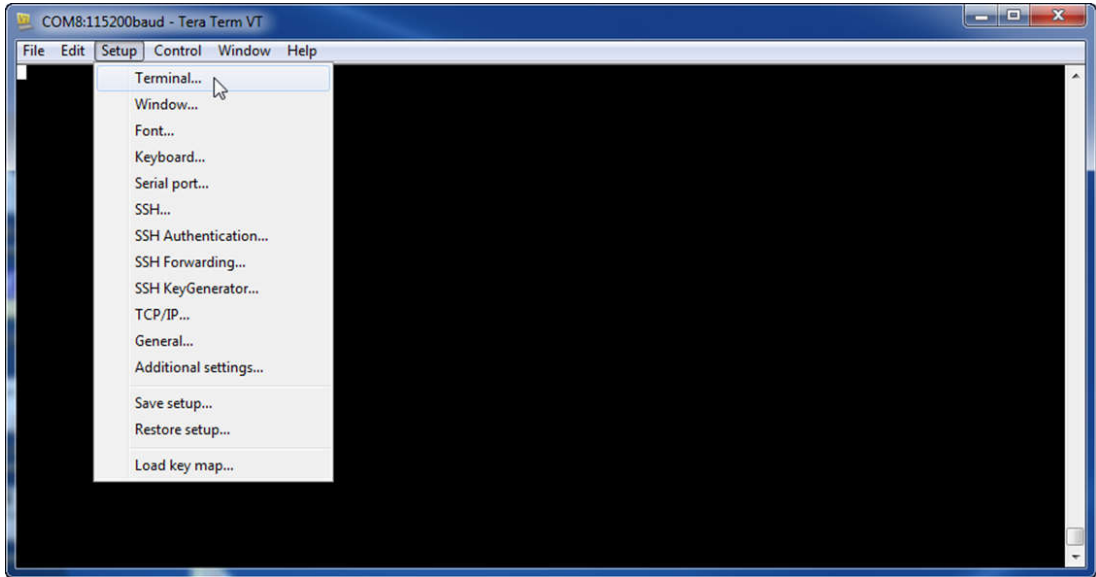

Figure 6.3: Selecting the Terminal Setup window

3. Change the default setting of CR to LF from the Receive drop-down menu and press OK.

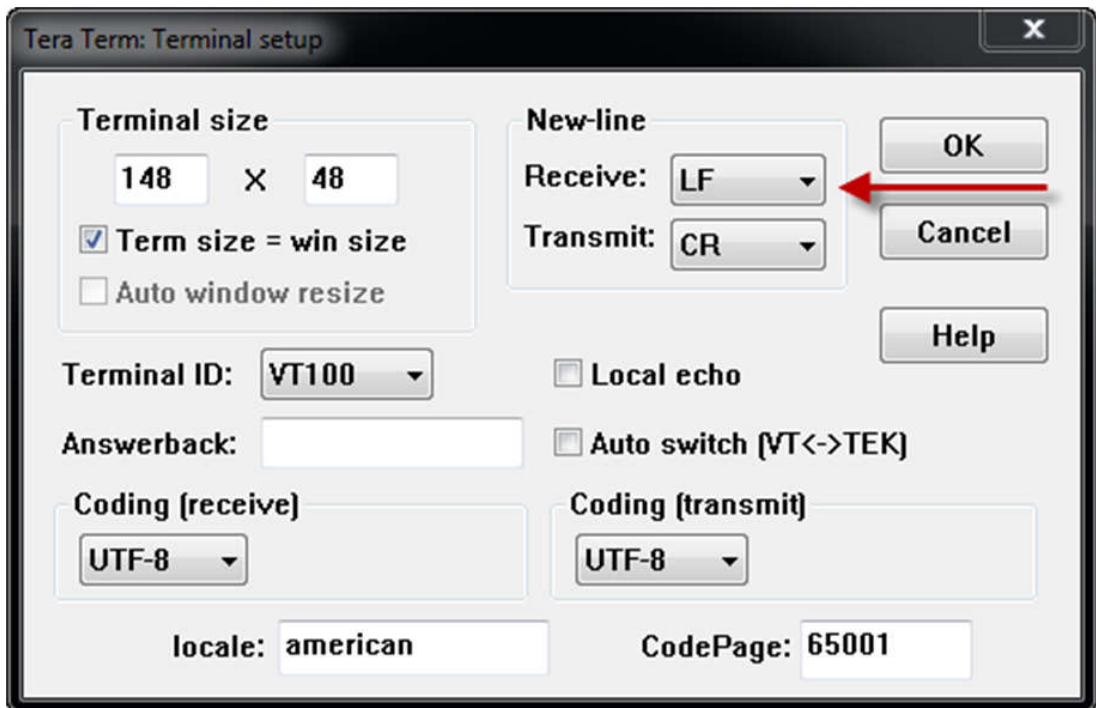

Figure 6.4: Changing the Receive: option to LF

4. Click Save setup.

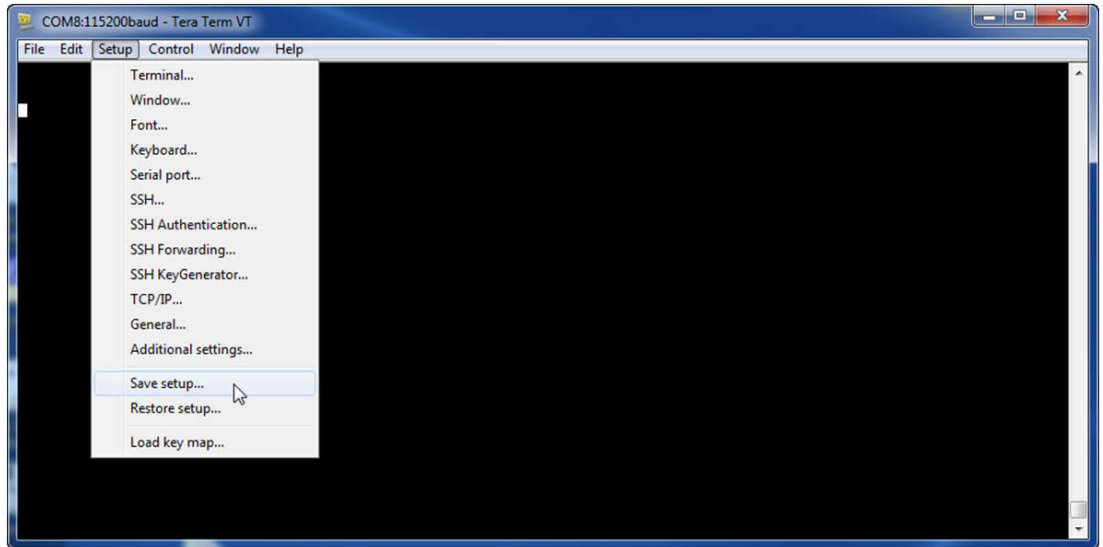

Figure 6.5: Saving the setup

5. Click Save to overwrite the existing TERETERM.INI file. This stores the new setting, and allows you to have the correct display settings when you launch Tera Term in future sessions.
6. Click the correct port option in the Port: drop-down menu for the B465.

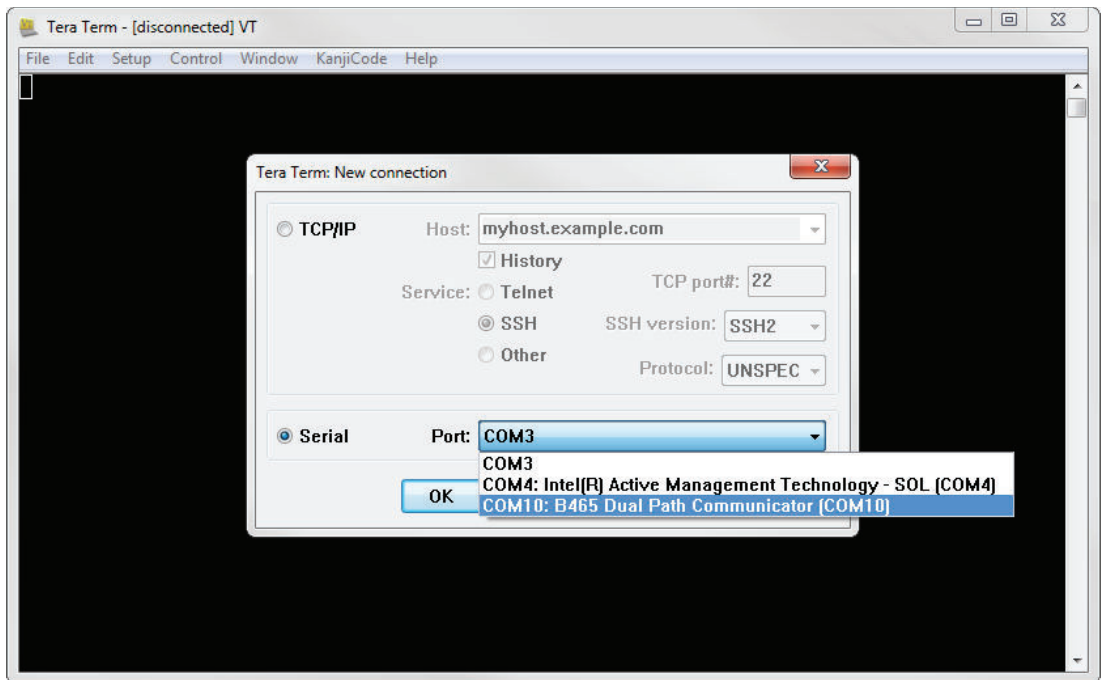

Figure 6.6: Tera Term Pro window shown

6.3 Log into the USB interface

Perform the following to log into the USB interface:

1. Ensure that the USB-Type A male-to-male cable is connected to the B465 and the target computer.
2. From Windows, start a terminal session by launching Hyper Terminal on Windows Vista/Windows 7/Windows 8 Windows, or launching Tera Term on Windows XP or earlier

3. Set up a connection on the new virtual serial COM port (for example, Port: COM7: B465 [COM7]). If the B465 is not connected to the computer, or the USB driver is not installed, the B465 does not appear in the list.
4. After the connection is established, press [Enter].
The B465 USB login window opens.

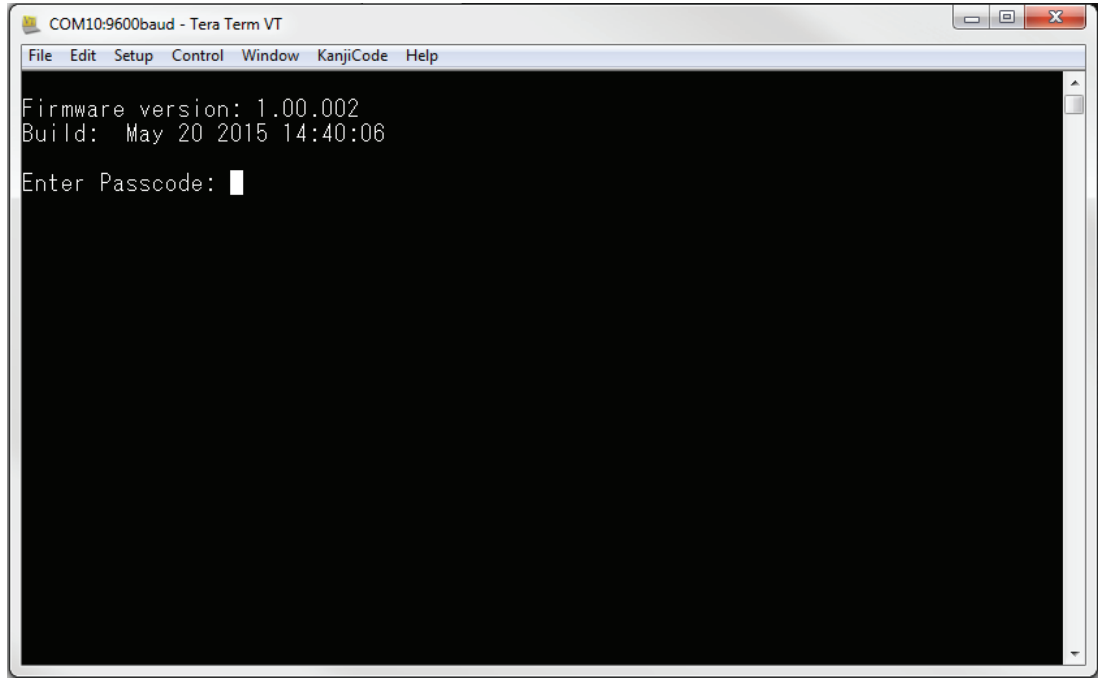

Figure 6.7: B465 USB login window

5. Enter the password to log on. The default password is B465.
The user interface allows three attempts to enter the password correctly. After three failed attempts, the B465 shows a Too many attempts error message, and the USB interface enters into an idle state for 30 seconds. Repeat Steps 3 through 6. at the conclusion of 30 seconds.
6. Press [Enter] to continue. The USB main menu opens.



Notice!

Please write down the password. If you forget your password we can only default the module after it is returned and will not be able to help you restore the module in the field.

6.3.1

USB Main menu screen

The following illustration shows a basic USB menu screen.

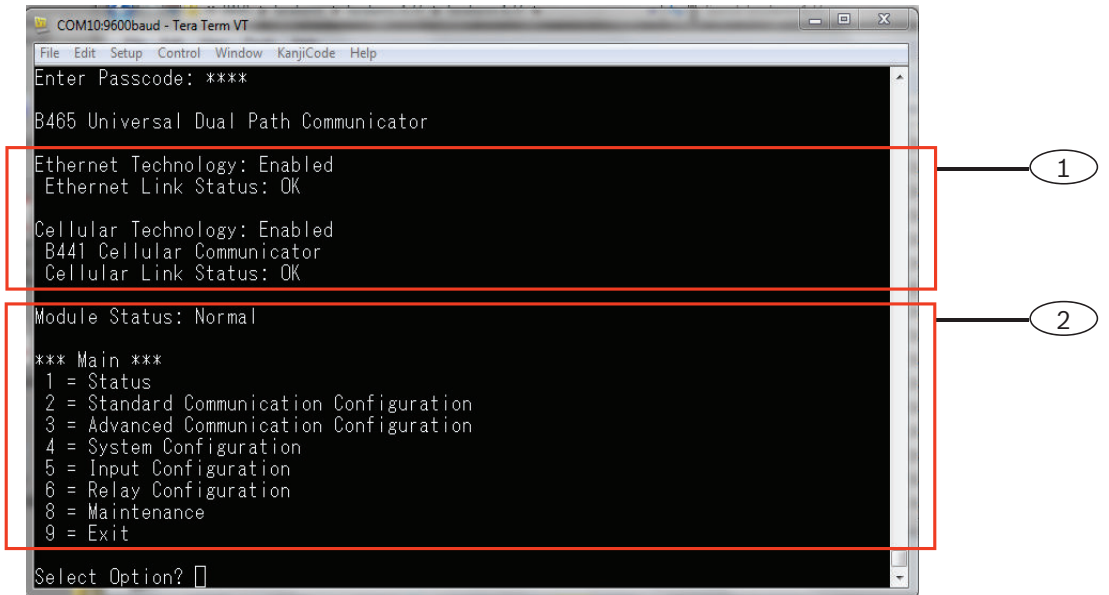

Figure 6.8: USB Main Menu

Callout — Description
1 — Selected technology (depending on the technology selected, Ethernet technology, and/or Cellular technology shows)
2 — Main menu options

The USB menu appears:

- After a user enters a password successfully
- Every time the user presses [Enter] without first selecting an option from the main screen
- Upon returning from a sub-menu

6.3.2 USB menu structure

The following illustrations depict the B465 menu structure.

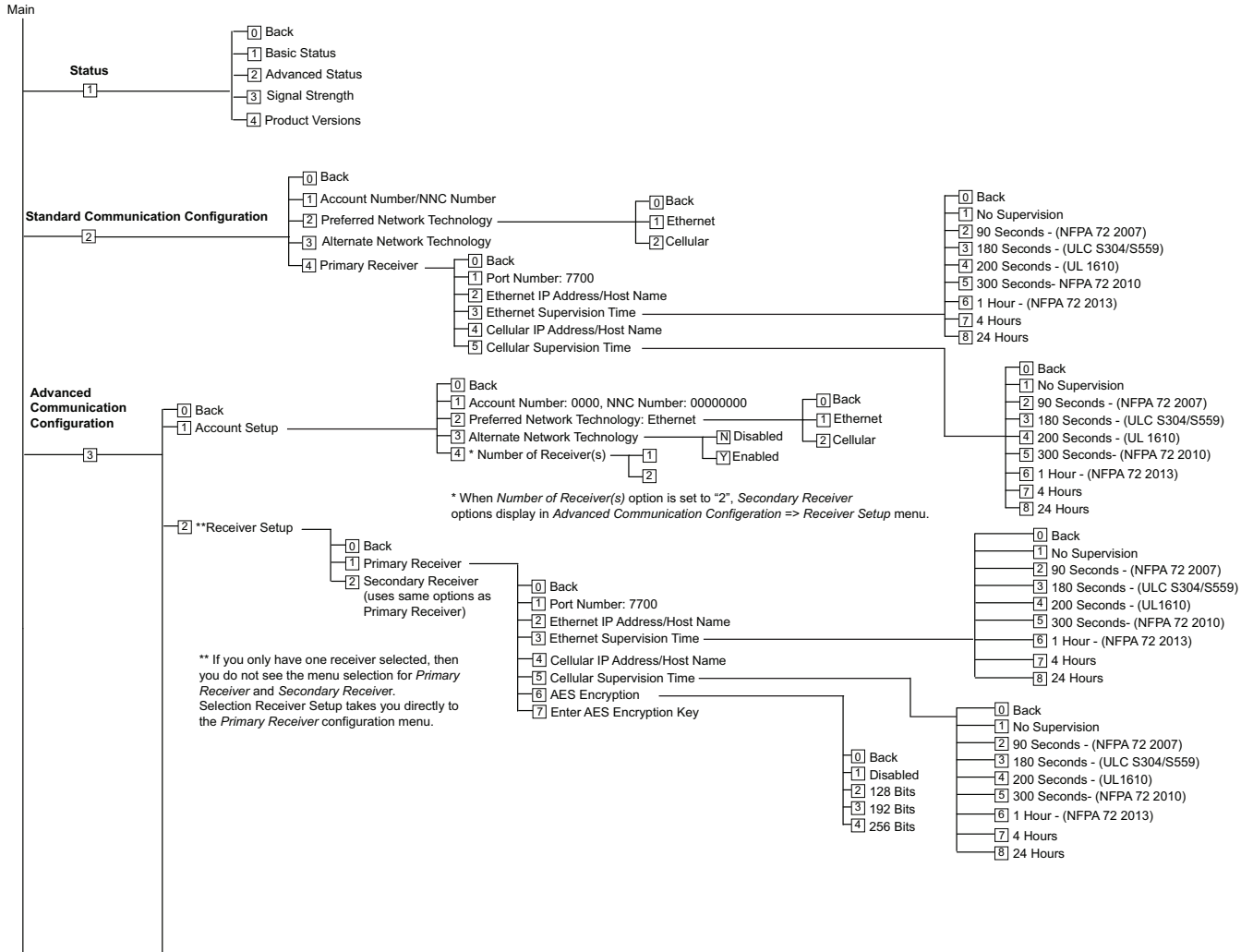

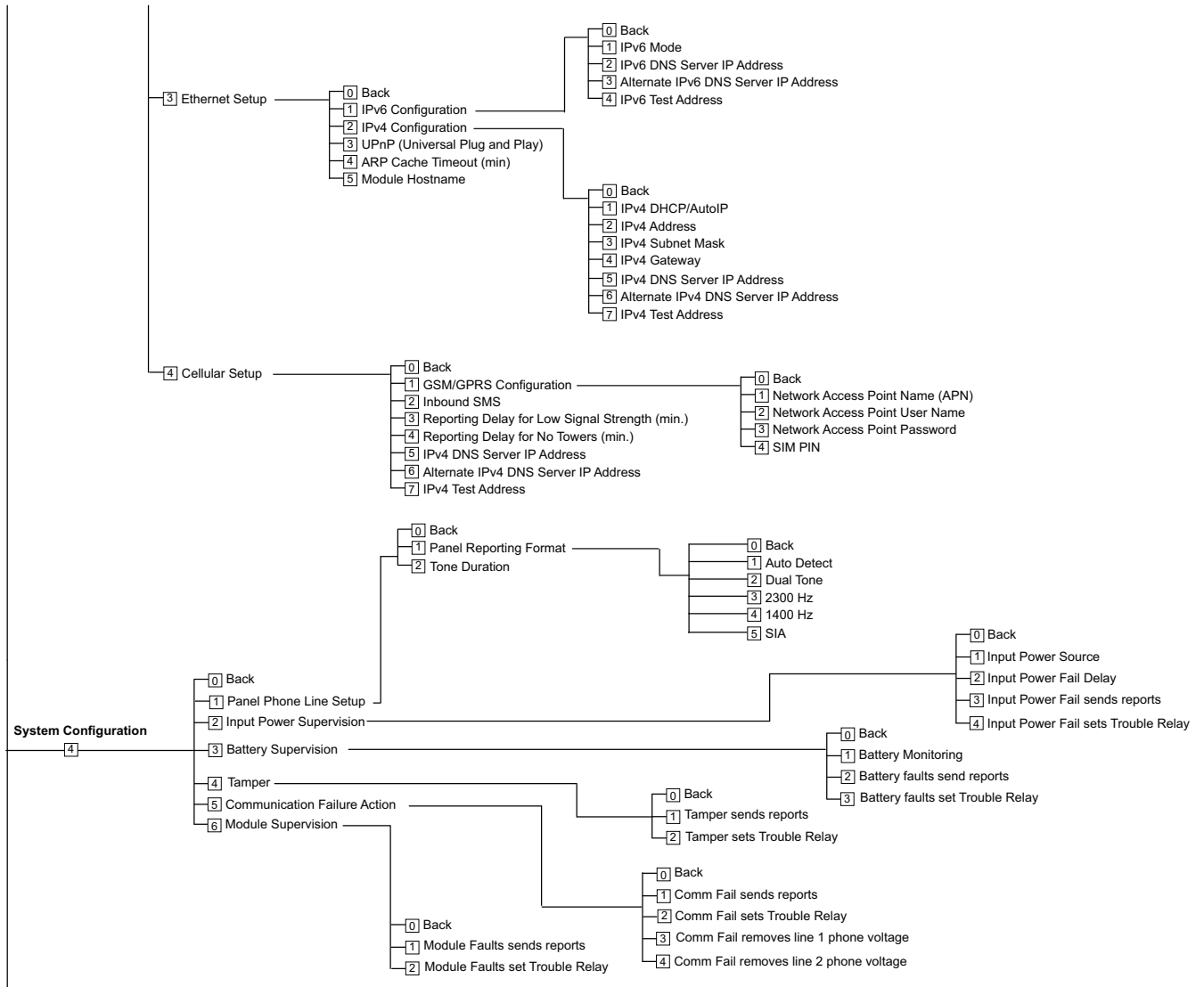

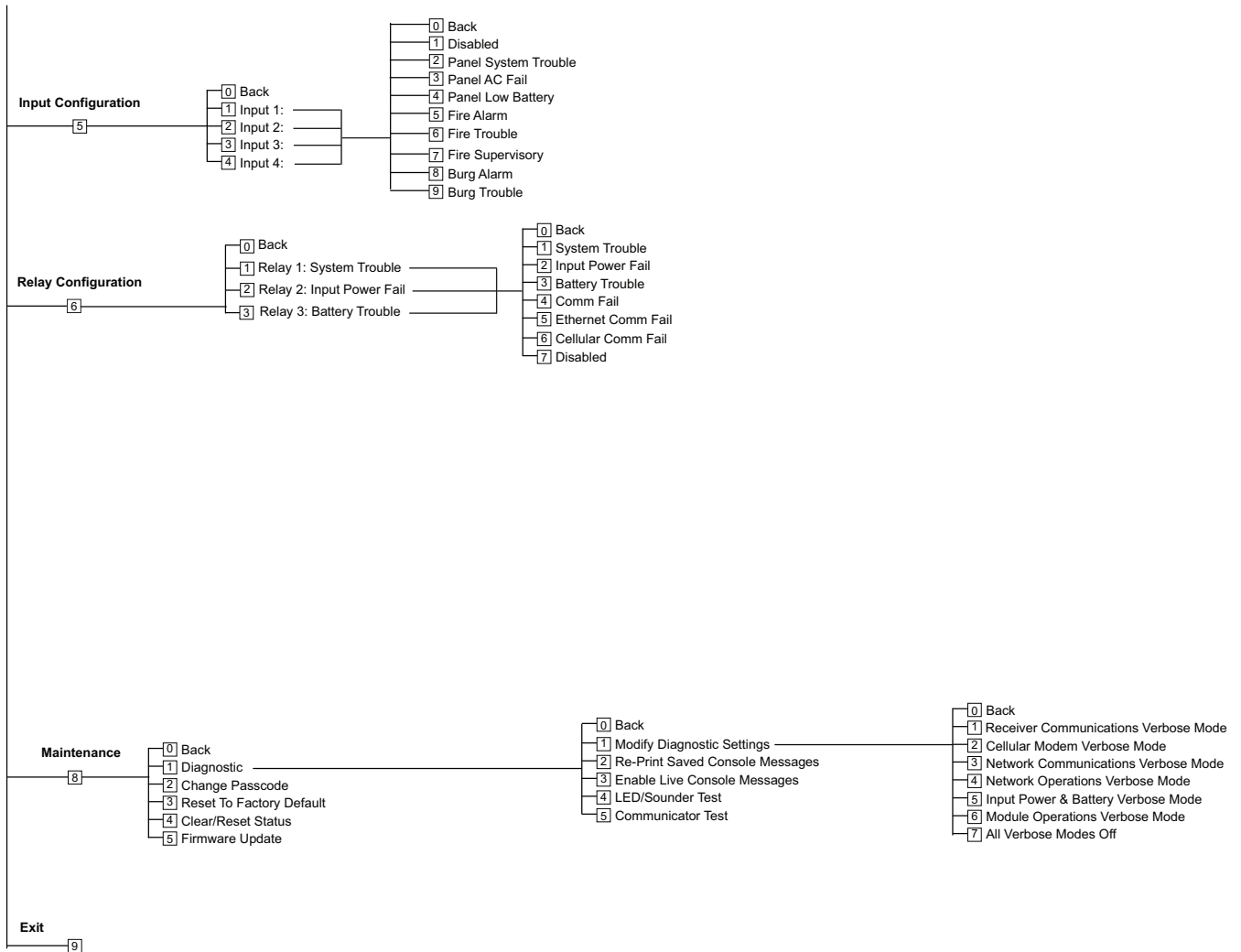

6.3.3 USB menu options

The USB menu option shows when a user enters in the correct passcode. General module and communication status are also shown in this screen. Refer to the tables in the following sections for a description of the USB menu options.

To go to a specific menu option, enter the appropriate menu option number.



Notice!

Any and all unsaved changes are lost if no keys are pressed within 5 minutes. The USB menu automatically logs out.

Using the Escape (Esc) key

Pressing the Escape (Esc) key without making any programming changes returns you to the previous menu. Pressing the Escape key after entering data clears data entered.

Option	Press to select	Description
1. Status	1	Select to access and view the link, modem, and bus status.
2. Standard Communication Configuration	2	Select to create/change configuration parameters such as account number, preferred network technology, receiver, and other network configuration values. This menu is designed for quick standard configurations using 1 receiver and no encryption.
3. Advanced Communication Configuration	3	<p>This menu is designed for more advanced configurations like 2 receivers, encryption, Ethernet and cellular parameter changes, and DNS modifications, to name a few.</p> <p>Select to program Advanced Configuration options. Press 0 to return to the Main menu.</p> <p>To change an advanced parameter, select the option to change, and then enter in the new value.</p>
4. System Configuration	4	Select to program various system-related configuration options such as battery supervision, communication failure actions, module supervision, control panel phone line setups, tamper reporting, and input power selection/supervision.
5. Input Configuration	5	<p>Select to disable or enable each input terminal (1 to 4) independently of one another. The default position is Disabled. If enabled, the selected option transmits the event report to the Central Station when the input is shorted, or troubled if opened.</p> <p>The B465 has 4 configurable inputs that can be used to send a variety of reports when the input is shorted. Connect these inputs to the control panel to send reports if the control panel has no PSTN dialer attached. Choose from the following:</p> <ul style="list-style-type: none"> - Disabled - Panel System Trouble - Panel AC Fail - Panel Low Battery - Fire Alarm - Fire Trouble - Fire Supervisory - Burg Alarm - Burg Trouble

Option	Press to select	Description
6. Relay Configuration	6	<p>Select to disable, or enable each relay (Relay 1 to Relay 3) independently of one another. This allows you to configure your relay outputs to perform a variety of functions.</p> <p>The B465 provides 3 relays that can be used to provide status to the local control panel or to turn on external devices like annunciator lights or buzzers as required. Configure the relays to turn on to activate these types of devices to alert you when the B465 is detecting a trouble. Choose from the following:</p> <ul style="list-style-type: none"> - System Trouble - AC Fail - Battery Trouble - Comm Fail - Ethernet Comm Fail - Cellular Comm Fail - Disabled <p>It is recommended that Relay 1 be used for System Troubles as it is a fail-sail relay that will de-energize if there are hardware, software, or complete power failure to the module.</p>
8. Maintenance	8	<p>Select to update the firmware, change your passcode, reset factory defaults, run diagnostics, or clear/reset status.</p> <p>Notice!</p> <p>Download your update file from the Bosch website prior to performing an update. For more information on Firmware update workflows, refer to <i>Firmware Update page, page 71</i>.</p>
9. Exit	9	<p>Select to exit the menu and log out. You must enter the passcode to log back in.</p> <p>Notice!</p> <p>If configuration changes have been made but not saved, you will be prompted to save or discard them.</p>

6.3.4

Status menu

The Status Menu consists of:

- Basic Status
- Advanced Status
- Signal Strength
- Product Versions

```

Select Option? 1
----- B465 Basic Status -----

  *** Ethernet Technology Status ***
Ethernet Hostname: B042725
MAC Address:      00-04-63-04-27-25
IPv4 Address:     192.168.0.4
IPv4 Link Status: OK

  *** Cellular Technology Status ***
Electronic Serial #: A1000032B319C3
Telephone Number:   315-310-0341
IPv4 Address:       10.33.1.54
Signal Strength:    Good
Data Status:        Connected
IPv4 Link Status:   OK

  *** Receiver Status ***
Primary Rcvr Encryption: Disabled

  *** Module Status ***
No faults or troubles found

*** Status ***
0 = Back
1 = Basic Status
2 = Advanced Status
3 = Signal Strength
4 = Product Versions
    
```

Figure 6.9: Basic Status screen

For a description of the Status sub-menu parameters, refer to the table below.

To go to a specific Status menu option (Basic Status, Advanced Status, Signal Strength, and Product Versions), make the desired selection.

Status Menu

Accessing the Status Menu:

1. Enter the B465 passcode
2. Press **[1] Status**.
3. Select the desired parameter (Basic Status, Advanced Status, Signal Strength, and Product Versions) from the table below.

Option	Press to select	Description
1. Basic Status Menu	1	This option shows the current Ethernet technology, IP address, link status, modem status, , and module status.
2. Advanced Status Menu	2	This option shows various parameters related to the cellular device such as UDP packets transmitted and received, the carrier name, available towers, and data class.

Option	Press to select	Description
3. Signal Strength	3	<p>The current signal strength records every 15 minutes for up to 48 hours worth of data. When signal strength is selected, up to 192 values are displayed representing the signal strength values over the last 48 hours. If the B465 has been powered up less than 48 hours, the list shows only the samples taken so far. If it has been less than 15 minutes, “Signal Strength Not Available” shows. The screen shot below is an example of what you might see in the signal strength history.</p> <pre> *** Signal Strength History *** (Oldest value (dB) is printed first in 15 minute intervals.) -60 -56 -57 -56 -58 -58 -57 -59 -58 -59 -60 -60 -64 -60 -61 -60 -63 -62 -60 -60 -60 -61 -61 -61 -60 -59 -61 -61 -60 -59 -61 -64 -60 -63 -60 -60 -60 -61 -58 -59 -59 -59 -60 -61 -59 -59 -60 -59 -59 -60 -59 -60 -59 -60 -59 -60 -59 -63 -61 -60 -62 -61 -61 -59 -59 -61 -60 -58 -60 -58 -59 -59 -60 -59 -60 -61 -60 -60 -59 -60 -60 -59 -60 -62 -60 -57 -58 -58 -61 -58 </pre>
4. Product Versions	4	<p>This option shows the software version of all entities in the B465 . The following list is an example of the versions shown:</p> <pre> *** Product Versions *** B465 Product ID: 88096.16041400007 B465 Application: V 3.01.032 B465 Boot Loader: V 1.05.001 B465 Hardware: V 1.00.000 RTOS: V 3.03.600 Fusion Stack: V 8.07.5603 Cellular Manager: V 2.00.3203 UPKI Encryption: V 3.03.002 AES Lib: V 01.00.000 Modem Firmware: V 15.00.021 </pre>

Table 6.1: Status sub-menu parameters

Link Status

Parameter	Description
IP Address	Cellular Network. This field displays the current Cellular Network IP Address. An IP address of 0.0.0.0 is listed when no IP address is found.
	Ethernet Network. This field displays the current Ethernet Network IP Address. An IP address of 0.0.0.0 is listed when no IP address is found.
Link Status	Cellular Network. This field displays the connection status to the cellular network. This field displays either OK, or Error.
	Ethernet Network. This field displays the connection status to the Ethernet network. This field displays either OK, or Error

Encryption	This field displays either Normal, or Trouble:
Socket xx: Port Number	This field displays the current open Port Numbers and Data Types (up to 32).

Modem Status

The information below shows in the appropriate fields. If no modem status is detected, the following message appears: Modem status is not available.

Parameter	Description
Electrical Serial # (ESN)	This field displays the B44x radio modem serial number.
Data Status	This field displays one of the following; Disconnected, Connecting, or Connected.
Signal Strength	This field displays the current signal strength. One of the following appears; Very good, Good, Marginal, Unacceptable, or Unavailable.

Module Status

Module Status shows only when there is a trouble status.

- B44x Plug-in Missing
- Detecting Plug-in
 - B44x Plug-in Missing
 - B44x Plug-in Invalid
 - No IP Address
 - Detecting Plug-in
 - Signal Strength Low
 - Too Few Towers
 - No Towers
 - B44x Not Active
 - B44x Failure
 - Configuration Failure
 - Low Bus Voltage
 - No Bus Communication
 - Switch in Position 0
 - Firmware Checksum Error
 - Configuration Checksum Error
 - SIM Missing
 - SIM PIN Wrong
 - SIM PIN Lockout
 - Invalid Access Point
- No IP Address
- Battery missing
- Ethernet Cable Open

6.3.5

Advanced Status menu

You must enter the Status menu in order to get to Advanced Status.

Accessing the Advanced Status Menu parameters:

1. Enter the passcode to launch the USB menu.
2. Enter **[2] Advanced Status**. The Advanced Status option appears.

The following section describes the description of the Advanced Status menu information.

```

----- B465 Advanced Status -----
*** Ethernet Technology Status ***
DNS Server IPv4 Address: 192.168.0.1
DNS Status: OK
Ethernet packets sent: 63
Ethernet packets received: 63

*** Cellular Technology Status ***
Transceiver Model #: DE910-DUAL
Carrier Name: Verizon
Base Station ID: 4629,6,154
Towers Available: 1
Current Band: CDMA 1900 MHz
Data Class: 3G
Signal Strength: -75 dbm
Temperature: 28C
DNS Server Address: 198.224.187.135
Alternate DNS Address: 198.224.186.135
DNS Status: OK
Cellular packets sent: 3
Cellular packets received: 0

*** Receiver Addresses ***
Receiver 1 Ethernet IPv4: 192.168.0.12
Receiver 1 Cellular IPv4: 192.168.0.12

*** Phone Statistics ***
Phone events transmitted: 0
Phone events acknowledged: 0

*** Status ***
0 = Back
1 = Basic Status
2 = Advanced Status
3 = Signal Strength
4 = Product Versions

Select Option? █

```

Figure 6.10: Advanced Status screen

Advanced Link Status

Parameter	Description
Internet (ping)	This field shows one of the following; OK, Error, No Status (no ping has been performed).
IPv4 DNS Server IP Address	This field shows the current IP address.
Alternate IPv4 DNS Server IP Address	This field shows an alternate IP address.
DNS Status	This field shows one of the following; OK, Error, No Status (no DNS lookup (has been performed).
UDP Packets Transmitted	This field shows the packets transmitted over the Ethernet or cellular reporting path from power up, or Option 3 (Reset Status).

Advanced Modem Status

Parameter	Description
Transceiver Model number	This field shows one of the following; DE910-DUAL, CE910-DUAL, GE910-QUAD, HE910-D.
Carrier Name	This field shows the carrier network providing service.

Parameter	Description
Data Status	This field shows one of the following; Disconnected, Connecting, or Connected.
Signal Strength	This field shows the current signal strength in dbm.
Towers Available	This field shows the number of towers that can be detected by the module.
Base Station ID	This field shows information about the tower you are currently connected to.
Current Band	This field shows the current band frequency.
Data Class	This field shows one of the following; 1xRTT, 3G, GPRS, EDGE, WCDMA, HSPA.
Temperature	This field shows the internal temperature of the radio transceiver (in Celsius).

6.3.6

Standard Communication Configuration

This option allows you to enter in your account number, preferred network preference, and program your primary receiver.

To go to Standard Communication Configuration, perform the following:

1. Enter the B465 passcode
2. Press **[2]** Standard Communication Configuration.
3. Enter the desired port number value.

Refer to the table below for Standard Communication Configuration descriptions.

Option	Press to start	Description
1. Account Number/NNC Number	1	Select this option to enter in the account number. This information should be obtained from your central station.
2. Preferred Network Technology	2	Select this option to choose your preferred communication environment. Available options include: <ul style="list-style-type: none"> - Ethernet - Cellular Ethernet is the default option.

3. Alternate Network Technology	3	<p>Select this option to choose an alternative communication environment. This option automatically becomes active when the preferred network technology is disabled, or goes down.</p> <p>Available options include:</p> <ul style="list-style-type: none"> - Enabled - Disabled <p>Disabled is the default option.</p>
4. Primary Receiver	4	<p>Select this option to enter in the port number, Ethernet IP address/host name, Ethernet supervision time, Cellular IP address/host name, and/or Cellular supervision time. This information should be obtained from your central station.</p> <p>Available options include:</p> <ul style="list-style-type: none"> - Port Number (default is 7700) - Ethernet IP Address/Host Name (default is None) - Ethernet Supervision Time (default is 1 hour) - Cellular IP Address/Host Name (default is None) - Cellular Supervision Time (default is 1 hour) <p>When you enter information in the Ethernet IP Address/ Host name it is automatically filled into the cellular field as well. If you need to point cellular to a different address/host name, type the appropriate information into the cellular field.</p>

6.3.7

Advanced Communication Configuration

This option allows you to enter in your account setup, receiver setup, Ethernet, and cellular setups.

To go Advanced Communication Configuration, perform the following:

1. Enter the B465 passcode.
2. Press **[3]** Advanced Communication Configuration.
3. Enter the desired port number value.

Refer to the table below for Advanced Communication Configuration descriptions.



Notice!

Entering in the Account Setup creates the NNC number used by the central station receiver. If a 10 digit account code is used, the NNC only accepts the first 8 digits. For example, if an account number is 1234567890, the NNC number is 34567890.

Option	Press to start	Description
1. Account Setup	1	<p>Select this option to enter in the account setup information, preferred network technologies, an alternate network technology, and/or adding an additional receiver. Available options include:</p> <ul style="list-style-type: none"> - Account Number:0000, NNC Number: 00000000. Use this option to enter in the account number of your monitoring service. - Preferred Network Technology. Use this option to select the desired network technology, Ethernet, or cellular. - Alternate Network Technology. Use this technology to select the desired backup network technology; Ethernet or cellular. - Number of Receiver(s). Use this option to select another receiver. This could be a backup receiver at your central monitoring station.
2. Receiver Setup	2	<p>Select this option to configure your primary and secondary receiver environment. You must change the number of receivers to 2 under the account setup first before you can see the secondary receiver settings. Available options are:</p> <ul style="list-style-type: none"> - Primary Receiver - Secondary Receiver <p>Primary Receiver is the default option.</p>

Option	Press to start	Description
3. Ethernet Setup	3	<p>Select this option to configure your Ethernet network environment. This option allows you to enter in your IPv4 or IPv6 configuration, enable UPnP, assign ARP Cache Timeout values, or a Module Hostname. Available options include:</p> <ul style="list-style-type: none"> – IPv6 Configuration. Use this option to program your IPv6 mode, DNS server IP address, an alternate IPv6 DNS server IP address, and/or an IPv6 test address. – IPv4 Configuration. Use this option to program your IPv4 DHCP/AutoIP, configure the IP address, subnet mask, and gateway, an alternate IPv4 DNS server IP address, and/or an IPv4 test address. – UPnP (Universal Plug and Play). Use this option to enable or disable universal plug and play. UPnP is the default option. – ARP Cache Timeout (mm). Use this option to adjust the timeout values for resolving IP address issues between the module and central station receiver(s), as well as updating the IP address table. 10 minutes is the default option. – Module Hostname. Use this option to enter in the hostname of the B465 module to the connected router. An empty string is the default option.
4. Cellular Setup	4	<p>Select this option to configure your cellular network. Available options include:</p> <ul style="list-style-type: none"> – Network Access Point Name (APN). Use this option to specify the name of the network connection point for cellular communications. Wyless.apn is the default option. – Network Access Point User Name. Use this option to specify the login name used by the B465 module when logging into the network. This option is only applicable to the B442 and B443 cellular communication modules. A blank string is the default option. – Network Access Point Password. Use this option to specify the password used by the B465 when logging into the network. This option is only applicable to the B442 and B443 cellular communication modules. A blank string is the default option. – SIM PIN. Use this option to set the PIN in the B465 to match the SIM card pin in the cellular communicator module (for B442 and B443 only). A blank string is the default option. – Inbound SMS. Use this option to allow B465 configuration to allow SMS messages to be received. Enabled is the default option. – Reporting Delay for Low Signal Strength (min). Use this option to set the duration of time when the B465's signal strength is measured. The value selected determines how long the signal strength must be at a low condition before

Option	Press to start	Description
		<p>reporting as low, or how long the signal strength must be normal before reporting as normal. (30) is the default option.</p> <ul style="list-style-type: none"> - Reporting Delay for No Towers (min).Use this option to set the amount of delay before the module reports a trouble for not being able to receive signals from a cell tower. (30) is the default option. - IPv4 DNS Server IP Address. Use this option to,... - Alternate IPv4 DNS Server IP Address. Use this option to. - IPv4 Test Address. Use this option to

6.3.8 System Configuration

This option allows you to configure your B465 phone line setup, input power and battery power supervision settings, tamper reporting, communication reporting, and module supervision.

Setting the System Configuration option:

1. Enter the B465 passcode.
2. Press **[4]** System Configuration.
3. Enter the desired options.

Refer to the table below for System Configuration descriptions.

Option	Press to select	Description
1. Panel Phone Line Setup	1	<p>Select this option to configure the manner in which the control panel's phone line(s) respond to various phone dialing behaviors. Other options include setting the tone duration, and the number of phone lines that are connected. Select the format of the control panel reporting. Available options include:</p> <ul style="list-style-type: none"> – Auto Detect. Use this option to allow the B465 to cycle through the supported handshake tones until a response is received. The handshake order is 2300, 1400, Dual Tone, SIA. – Dual Tone. Use this option for Contact ID (SIA DC-05) formats. – 2300 Hz. Use this option for pulse formats requiring a 2300 Hz acknowledgement tone. – 1400 Hz. Use this option as the default handshake tone – SIA. Use this option for SIA (SIA DC-03) formats. – Auto Detect is the default option <p>Notice! Some control panels need the correct handshake sent the first time or they will not send their data. if the phone LEDs flash a pattern indicating no data received or data error try selecting the control panel's communication format.</p>
2. Input Power Supervision	2	<p>Select this option to configure the B465 for monitoring and report sending when related to Input power issues. Input failures cause the System Trouble output to be activated. Available options include:</p> <ul style="list-style-type: none"> – Input Power Source. Use this option select the primary input power. Available options include AC (from transformer) or DC (24VDC from control panel or power supply). AC is the default option. – Input Power Fail Delay. Use this option to specify the duration of time after the B465 detects input power failure or brownout, and it transmits an Input Power fail report. 60 minutes is the default option. – Input Power Fail sends reports. Use this option to send an Input Power Fail report. This occurs when the Input Power Fail Delay option expires in duration of time during an input failure or brownout. The B465 transmits an appropriate Input fail message to central station. Available options include Enable, or Disable. Enabled is the default option. – Input Power Fail sets Trouble Relay. Use this option to control any output configured for System Trouble, and if there is an indication of an input failure, or brownout. Available options include Enable, or Disable. Disabled is the default option.

Option	Press to select	Description
3. Battery Supervision	3	<p>Select this option to monitor battery behaviors. Available options include:</p> <ul style="list-style-type: none"> - Battery Monitoring. Use this option to determine if battery fault conditions are detected or ignored. Available options include Enable, or Disable. Enabled is the default option. - Battery faults send reports. Use this option to determine if the B465 generates an internal event report for battery faults and their restore. Available options include Enable, or Disable. Enabled is the default option. - Battery faults set Trouble Relay. Use this option to control any output configured for System Trouble, and if there is an indication of a battery fault condition is present. Available options include Enable, or Disable. Disabled is the default option.
4. Tamper	4	<p>Select this option to configure tamper event reporting. Available options include:</p> <ul style="list-style-type: none"> - Tamper sends reports. Use this option to control if the B465 generates an internal event report for tamper conditions and their restore. Available options include Enable, or Disable. Disabled is the default option. - Tamper set Trouble Relay. Use this option to control any output configured for System Trouble indicates trouble when a tamper condition is present. Available options include Enable, or Disable. Disabled is the default option.

Option	Press to select	Description
5. Communication Failure Action	5	<p>Select this option to monitor communication failures. Available options include:</p> <ul style="list-style-type: none"> – Comm Fail sends reports. Use this option to enable the B465 to insert a high priority event in the event queue for a Failure To Communicate Event, Contact ID code 354. The B465 processes the communication failure resulting in activating LEDs and outputs based on their configuration. Available options include Enable, or Disable. Enabled is the default option. – Comm Fail sets Trouble Relay. Use this option to indicate a trouble when a communication failure occurs between the control panel and the B465. System Trouble indicates a trouble condition when an output is configured for System Trouble. Available options include Enable, or Disable. Disabled is the default option. – Comm Fail removes panel phone line 1 voltage. Use this option to enable or disable this feature. When enabled, the phone line 1 voltage is removed to allow the connected control panel to detect failures on the supervised phone line. A communication failure displays on the control panel when this occurs. Available options include Enable, or Disable. Disabled is the default option. – Comm Fail removes panel phone line 2 voltage. Use this option to enable or disable this feature. When enabled, the phone line 2 voltage is removed to allow the connected control panel to detect failures on the supervised phone line. A communication failure displays on the control panel when this occurs. Available options include Enable, or Disable. Disabled is the default option.
6. Module Supervision	6	<p>Select this option to monitor the B465's supervision. Available options include:</p> <ul style="list-style-type: none"> – System Reset – Code Checksum failure – Parameter Checksum error – Ethernet <ul style="list-style-type: none"> – Network cable disconnected – Ethernet IP Address error – Ethernet DNS Lookup error – Cellular <ul style="list-style-type: none"> – Plug-in missing – Plug-in not recognized – SIM card missing – Invalid SIM pin – SIM PUK required – Invalid Access Point – Cellular IP Address error

Option	Press to select	Description
		<ul style="list-style-type: none"> - Low Signal Strength - No Towers - Cellular Number not activated - Cellular Modem failure - Cellular Configuration failure - Cellular DNS Lookup error - Module Faults sends reports. Use this option to allow the B465 to send module fault reports to central station. Available options include Enable, or Disable. Enabled is the default option. - Module Faults set Trouble Relay. Use this option to allow the B465 to detect module trouble conditions. Available options include Enable, or Disable. Enabled is the default option.

6.3.9 Input Configuration

This option allows you to independently configure your inputs (COM 1 to COM 4 terminals), to support a variety of functions.

Setting the Input Configuration option:

1. Enter the B465 passcode.
2. Press [5] Input Configuration.
3. Enter the desired options.

Refer to the table below for Input Configuration descriptions.



Notice!

The programming options for the various inputs is similar in design and functionality. Therefore, menu access workflows will be described once. If multiple inputs need to be configured, follow the same steps to program the remaining inputs.

Option	Press to start	Description
1. Input 1	1	<p>*Select this option to configure your input terminal. Available options include:</p> <ul style="list-style-type: none"> – Disabled. Use this option to prevent the B465 from transmitting any report events. The default is Disabled. – System Trouble. Use this option to allow the B465 to transmit a Contact ID code 300, System Trouble when an input is shorted. Contact ID code 371, Protection Loop Open occurs when the input loop is opened. – Panel AC Fail. Use this option to allow the B465 to transmit a Contact ID code 301, AC Loss when an input is shorted. Contact ID code 371, Protection Loop Open occurs when the input loop is opened. – Panel Low Battery. Use this option to allow the B465 to transmit a Contact ID code 302, Low System Battery when an input is shorted. Contact ID code 371, Protection Loop Open occurs when the input loop is opened. – Fire Alarm. Use this option to allow the B465 to transmit a Contact ID code 110, Fire when an input is shorted. Contact ID code 373, Fire Trouble occurs when the input loop is opened. – Fire Trouble. Use this option to allow the B465 to transmit a Contact ID code 373, Fire Trouble when an input is shorted. Contact ID code 373, Fire Trouble occurs when the input loop is opened. – Fire Supervisory. Use this option to allow the B465 to transmit a Contact ID code 200, Fire Supervisory when an input is shorted. Contact ID code 373, Fire Trouble occurs when the input loop is opened. – Burg Alarm. Use this option to allow the B465 to transmit a Contact ID code 130, Burglary when an input is shorted. Contact ID code 371, Protection Loop Open occurs when the input loop is opened. – Burg Trouble. Use this option to allow the B465 to transmit a Contact ID code 380, Sensor Trouble when an input is shorted. Contact ID code 371, Protection Loop Open occurs when the input loop is opened.
<p>*The programming for each input is the same as described for Input 1. Choose from the same list of options when configuring Input 2, Input 3, and/or Input 4.</p>		

6.3.10

Relay Configuration

This option allows you to independently configure your relay outputs (Relay 1 to Relay 3 terminals), to support a variety of functions.

Setting the Relay Configuration option:

1. Enter the B465 passcode.
2. Press [6] Relay Configuration.

3. Enter the desired options.
Refer to the table below for Relay Configuration descriptions.



Notice!

The programming options for the various relay outputs are similar in design and functionality. Therefore, menu access workflows will be described once. If you must configure multiple relays, follow the same steps to program the remaining relays.

The programming of output relays is interchangeable of one another in that, you could program Relay 1 and Relay 2 as “System Trouble“, and Relay 3 as “Input Power Fail.“ Or, you could program all 3 relays as “Ethernet Comm Fail“ outputs.

Option	Press to start	Description
1. Relay Configuration	1, 2, or 3	*Select this option to configure your relay terminals. The defaults for the Relays are as follows: <ul style="list-style-type: none"> - Relay 1 = System Trouble - Relay 2 = Input Power Fail - Relay 3 = Battery Trouble Available options include: <ul style="list-style-type: none"> - Disabled. Use this option to prevent the B465 from transmitting any report events. - System Trouble. Use this option to allow the B465 to transmit a Contact ID code 300, System Trouble when an input is shorted. Contact ID code 371, Protection Loop Open occurs when the input loop is opened. - Input Power Fail. Use this option to activate the trouble relay. The System Trouble output is activated when this option is selected. - Battery Trouble. Use this option to activate the trouble relay. The System Trouble output is activated when this option is selected. - Comm Fail. Use this option to activate the trouble relay. The System Trouble output is activated when this option is selected. - Ethernet Comm Fail. Use this option to activate the trouble relay. The System Trouble output is activated when this option is selected. - Cellular Comm Fail. Use this option to activate the trouble relay. The System Trouble output is activated when this option is selected.
*You can configure up to three relays. The programming for each relay is the same as described for Relay 1. Choose from the same list of options when configuring Relay 1, Relay 2, and/or Relay 3.		

6.3.11 Maintenance

This option allows you to configure various maintenance-related activities to your B465 module. Various activities include changing the passcode, running diagnostics, resetting to factory default settings, perform firmware upgrades, clear/reset status, and other tests. For a full listing and parameter description, refer to the table below .

Setting the Maintenanceoption:

1. Enter the B465 passcode.
2. Select [8] Maintenance.
3. Enter the desired options.

Refer to the table below for Maintenance and Maintenance sub-menu descriptions.

Option	Press to start	Description
*1. Diagnostic	1	Select this option to run various diagnostic procedures. Available options include: <ul style="list-style-type: none"> – Modify Diagnostic Settings. Use this option to determine which type of messages display during diagnostics. This option is for use only under Bosch direction. A sub-menu of options includes: <ul style="list-style-type: none"> – Receiver Communications Verbose Mode – Cellular Modem Verbose Mode – Network Communications Verbose Mode – Network Operations Verbose Mode – Input Power & Battery Verbose Mode – Module Operations Verbose Mode – All Verbose Modes Off – Re-print Saved Console Message. Use this option to print any diagnostic messages that have already occurred and are stored in the B465's buffer. This can print what just happened if an issue occurs. – Enable Live Console Messages. Use this option to provide real time output of diagnostic messages. This allows the computer running TeraTerm to log what is occurring in the module and can log for longer periods of time. – LED/Sounder Test. Use this option to test the operation of the piezo sounder. – Communicator Test Menu. Use this option to test communication paths between the B465 and the connected receivers.
2. Change Passcode	2	Select this option to change the passcode used to enter in the USB menu. Enter a new passcode twice to change it. The second entry confirms the new passcode. Passcodes must be 4-10 characters long, and are case-sensitive. 0-9, A-Z, a-z, and special characters are allowed.
3. Reset to Factory Defaults	3	Select this option to reset all factory default values. All fields are cleared and the factory default values are restored.

4. Clear/Reset Status	4	Select this option to reset the B465 status.
5. Firmware Update	5	Select this option to update the firmware of the B465. Notice! Download your update file from the Bosch website prior to performing an update. For more information on Firmware update workflows, refer to <i>Firmware Update page, page 71</i> .
*The Diagnostic parameter is used in troubleshooting communication issues with the B465. Use of the Diagnostic parameter is to be used only at the direction of TECHNICAL SUPPORT.		

6.4 Firmware Update page

Firmware updates are performed through the USB interface via a communication program such as Hyper Terminal or Tera Term.



Notice!

When performing a firmware update, verify that the update software file to be downloaded is the most current software update version. No changes to the firmware occur if the firmware update version is the same version as the current version installed on the B465.

1. Ensure that the USB cable is connected to the B465 and the target PC or laptop.
2. From Windows, start a terminal session by launching Tera Term on Windows Vista/Windows 7/Windows 8, or launching Hyper Terminal on Windows XP or earlier.
3. Log into the USB interface as described in Log into the USB interface, starting at *step 3*, and continuing through to *step 6*. The B465 USB login window appears, listing the current software version and build.

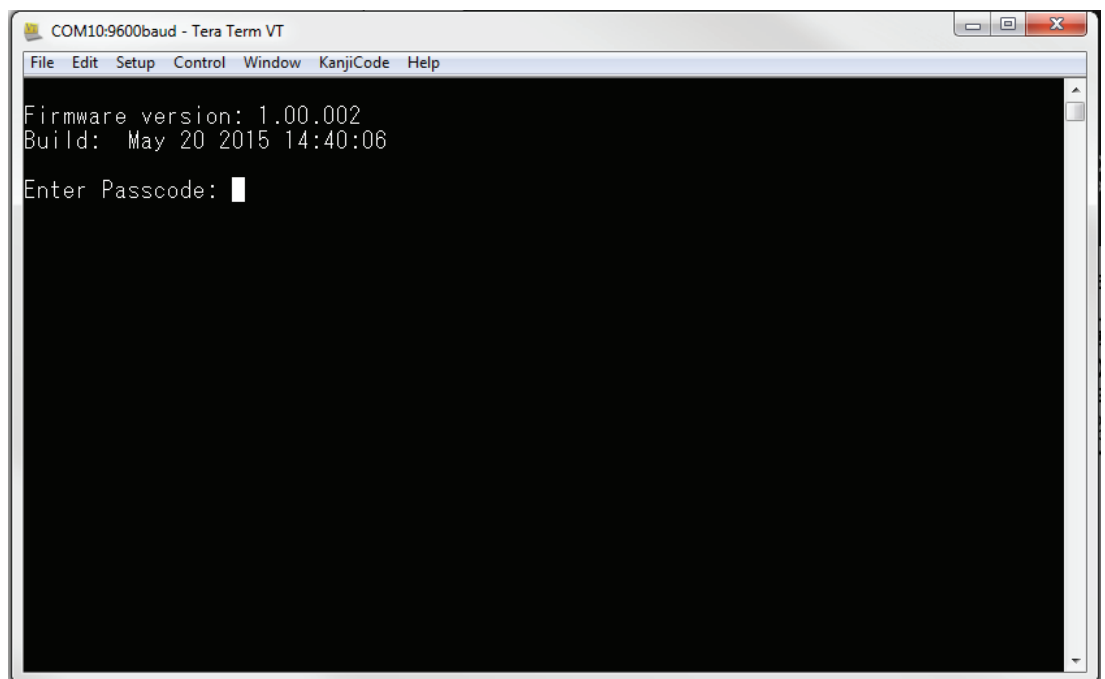

Figure 6.11: B465 USB login window

4. Select option 8 Maintenance.

5. Select option 5 Firmware Update and press [Enter].

**Notice!**

Once the Firmware Update menu item is selected, the B465 begins a 90 second timer as it waits for the firmware **File>Transfer>XMODEM>Send** process to begin. If the transfer process takes longer than 90 second to locate the file and begin the send process, the menu times out, and the user must begin the update process again.

6. From the Tera Term main menu, select File>Transfer>XMODEM>Send.

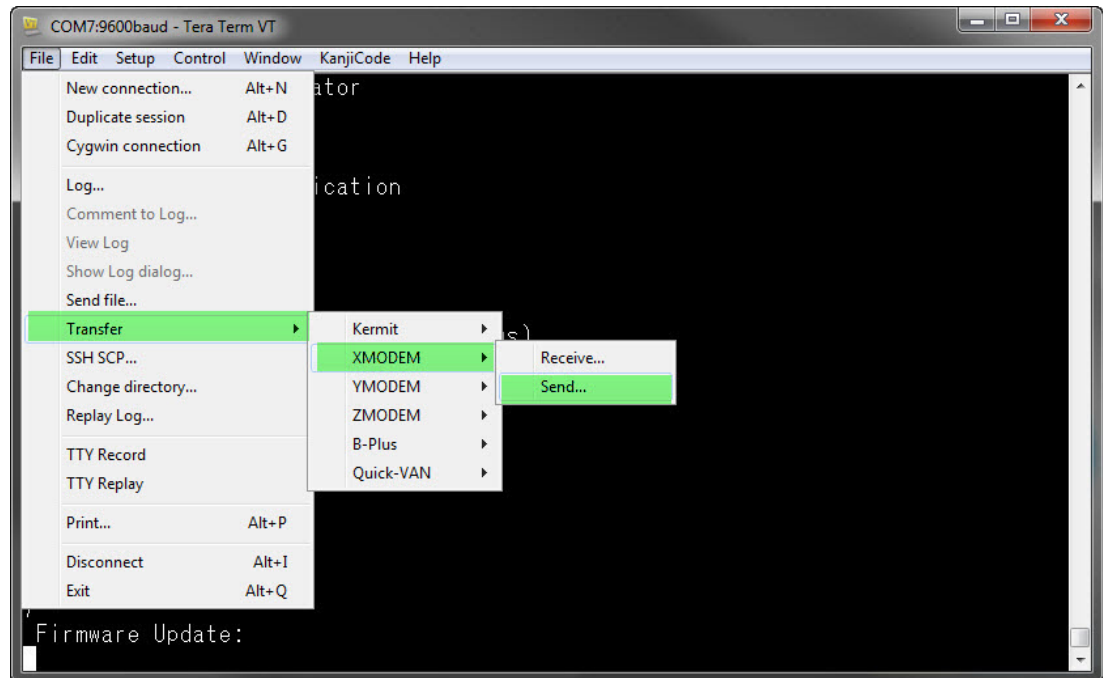

Figure 6.12: Firmware update send window

7. In the XMODEM Send dialog window, navigate to the folder location and select the firmware update software you downloaded. The file ends in *.kfw extension.

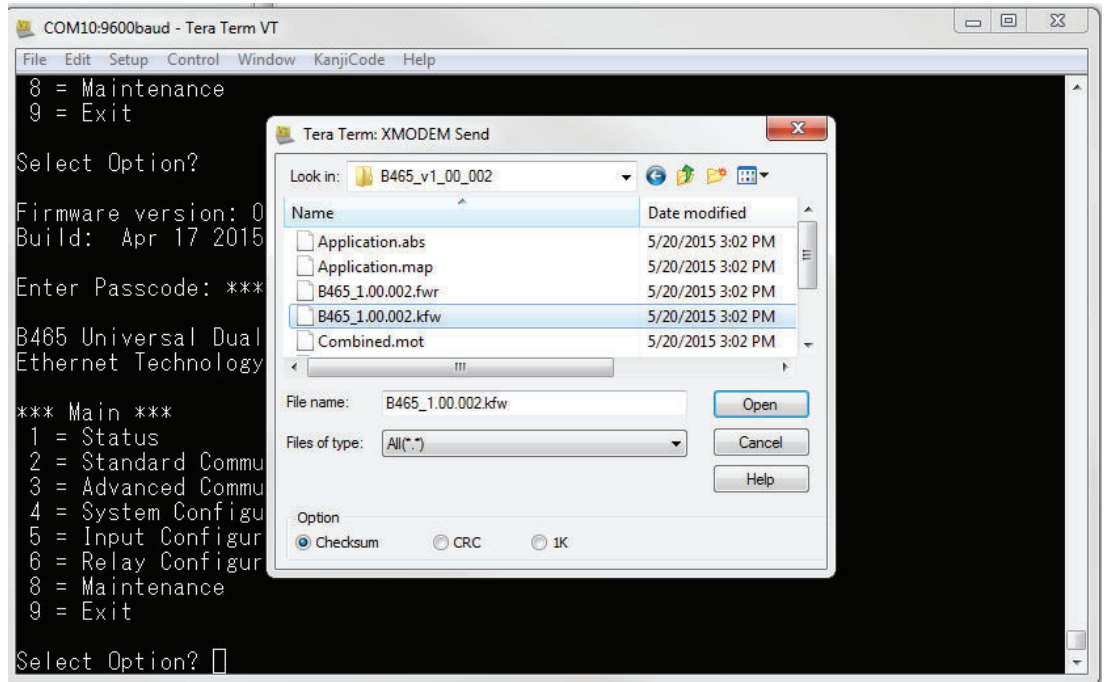

Figure 6.13: File navigation

8. Click Open to start the firmware update. The Tera Term: XMODEM Send dialog box opens and indicates the update process.

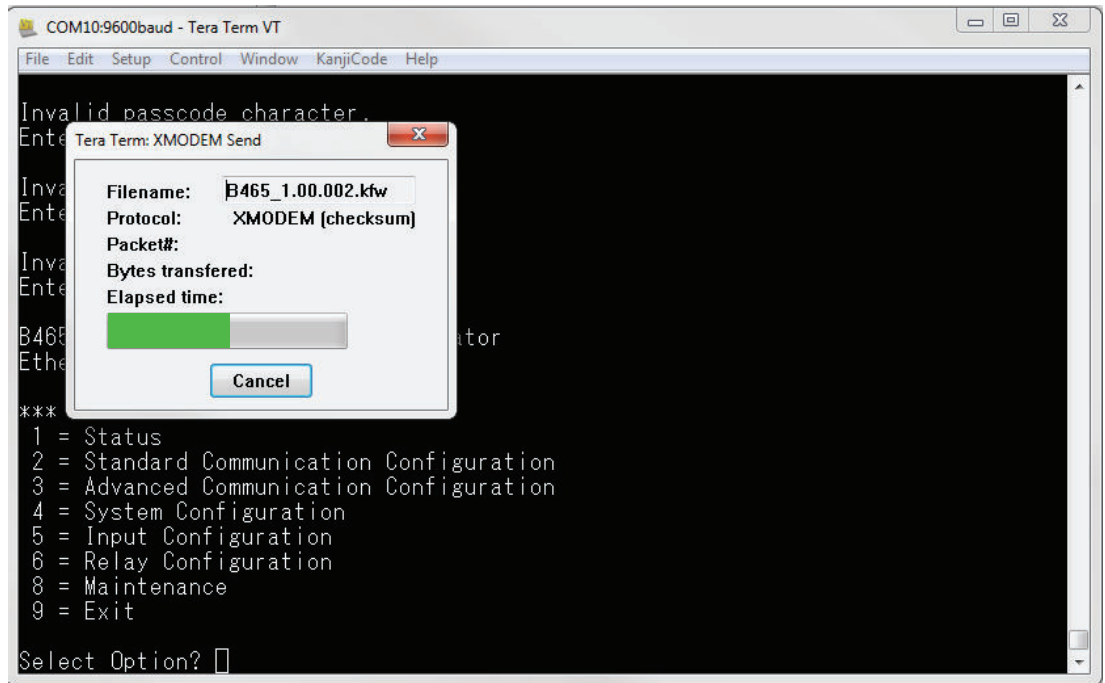

Figure 6.14: Tera Term XMODEM Send dialog box

9. When the file transfer completes, the Tera Term: XMODEM Send dialog box closes automatically. Within the Tera Term window an updating to firmware version "x.xx.xxx" message displays, and the B465 automatically reboots.
10. Close the Tera Term session, and re-launch Tera Term.

**Notice!**

Do not power off the module during this phase. Doing so might cause permanent damage to the B465.

-
11. Log back into Tera Term as described previously to re-establish communication from your laptop, to the B465 .

Communication between the B465 , receiver(s), and the connected control panel is restored.

7 Maintenance and troubleshooting

Refer to the following for maintenance and troubleshooting information.

7.1 LED status indicators

Refer to the following tables for LED status indicators.

On-board Ethernet LEDs



Flash pattern	Function
 On Steady	Communicating at 100 Mb.
 Off	Communicating at 10 Mb.

Table 7.1: 100BASE-T LED descriptions



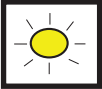

Flash pattern	Function
 On Steady	Plugged into an Ethernet network.
 Flashing	Communication in progress (flashes during communications, but remains on when not communicating).
 Off	Unplugged from an Ethernet network, or the Ethernet network is not available.

Table 7.2: LINK LED descriptions

Flash pattern	Function
 On Steady	Phone line 1/Phone line 2 OFF-HOOK.
 Flashing	Phone line 1/Phone line 2 off the hook for more than 120 seconds.
 Flashing	No data received on Phone line 1/Phone line 2.

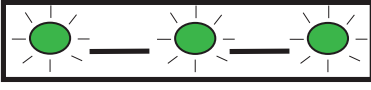

Flash pattern	Function
 Flashing	Data error on Phone line 1/Phone line 2.
 Off	Phone line 1/Phone line 2 ON-HOOK.

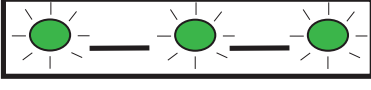
Table 7.3: Phone line 1 and 2 LED descriptions

Conettix Plug-in cellular module LEDs





LED	Function
 Blue	Indicates the overall status of the device.
 Red	Indicates an unacceptable signal strength level.
 Yellow	Indicates a marginal signal strength level.
 Green (1 light)*	Indicates a good signal strength level.
 Green (2 lights)	Indicates a very good signal strength level.
* One green LED indicates the minimum installation level.	

Table 7.4: Cellular module signal strength LED patterns

A single blue Status LED indicates the module status.

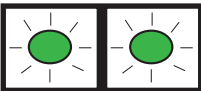

Flash pattern	Function
 Flashes once every 1 sec	Normal state. Indicates normal operation.
 3 quick flashes	Communication error state. Indicates the module is unable to communicate on the cellular network.
 Off	LED trouble state. Module is not powered, or some other trouble condition prohibits the module from controlling the heartbeat LED.

Table 7.5: Cellular module diagnostic LED patterns

SYSTEM TROUBLE LED patterns





Flash pattern	Function
 Off	Indicates normal operations.
 Flashing	Indicates Ethernet communication errors. Refer to SYSTEM TROUBLE Flashing (one flash) - Ethernet table for more information
 Flashing	Indicates cellular communication errors. Refer to SYSTEM TROUBLE Flashing (two flashes) – Cellular table for more information.
 Flashing	Indicates a communication trouble. Verify IP address and port numbers used by the central station. If it was running correctly and now shows this indication, check to make sure the account is enabled in the receiver or if there is an IP path problem preventing you from reaching the receiver.
 Flashing	Indicates multiple communication errors. Check the B465 USB status menu for additional information to help correct the problem.
 On Steady	Indicates all non IP communication troubles. For example low, or missing battery, phone lines are off the hook for more than 2 minutes, or there is a configuration issue.

Table 7.6: SYSTEM TROUBLE LED descriptions

SYSTEM TROUBLE Flashing (one flash) – Ethernet Trouble



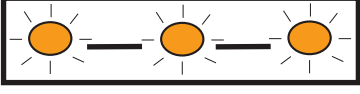
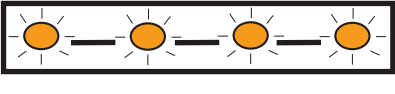













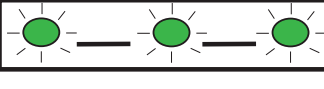

Flash pattern (TX)	Function
 Flashing	Indicates an Ethernet Network Cable open. Verify your Ethernet connection to the B465 is secure. Also verify the Ethernet connection is secure to your network.
 Flashing (two flashes)	Indicates an Ethernet IP Address error. Verify that DHCP is enabled if your network is assigning the IP address or that your network administrator has setup your device correctly. Refer to <i>USB menu options, page 52</i> to change/edit your IP address.
 Flashing (three flashes)	Indicates an Ethernet DNS Lookup error. Make sure you have access to an Internet connection that has access to the world wide web.

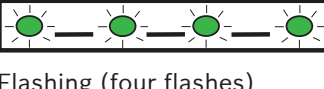
Table 7.7: Ethernet LED descriptions

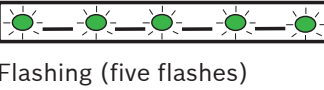
SYSTEM TROUBLE Flashing (two flashes) – Cellular Trouble

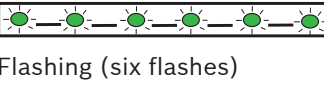
Heartbeat LED	RX LED	Plug-in Status LED	Function
 On Steady	 Flashing (one flash)	N/A	Indicates the plug-in module is missing. Verify the plug-in module is firmly inserted into the module connector.
 On Steady	 Flashing (two flashes)	 Off	Indicates the plug-in module is not recognized. Verify the correct plug-in module is firmly inserted into the module connector. Verify the latest firmware is installed to support the module you have.

Heartbeat LED	RX LED	Plug-in Status LED	Function
 On Steady	 Flashing (three flashes)	 Off	Indicates a cellular modem failure. Verify the plug-in module is firmly inserted into the module connector. If the problem still persists replace with another plug-in module to see if the problem is corrected.
 Flashing	 Flashing (four flashes)	 On Steady	Indicates a cellular DNS Lookup error. Check the name entered to verify it was entered correctly.
 Flashing	 Flashing (five flashes)	 On Steady	Indicates no activation. Check with your service provider to make sure the cellular module was activated.
 Flashing	 Flashing (six flashes)	 On Steady	Indicates an invalid access point. Check the APN against the APN required by your service provider.
 Flashing	 Off	 Flashing (one flash)	Indicates there are no towers available for the service provider. Try positioning the antenna in a different location. If that doesn't work try changing to a different service provider or cellular plug-in module that using the other technology..









Heartbeat LED	RX LED	Plug-in Status LED	Function
 Flashing	 Off	 Flashing (two flashes)	Indicates a cellular IP address error. Check with your service provider to make sure the cellular module was setup correctly.
 Flashing	 Off	 Flashing (three flashes)	Indicates the SIM Card is missing. Verify the SIM card is inserted into the B442 or B443 cellular communication module. Refer to the <i>SIM card, page 83</i> troubleshooting section for more information.
 Flashing	 Off	 Flashing (four flashes)	Indicates a SIM Card lockout. This requires that the SIM PIN be used to unlock the SIM card.
 Flashing	 Off	 Flashing (five flashes)	Indicates an invalid SIM PIN. Verify the correct SIM PIN was entered. Refer to the <i>PIN code, page 83</i> troubleshooting section for more information.

Table 7.8: POWER LED descriptions

POWER LED

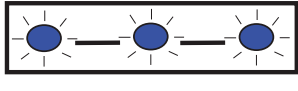

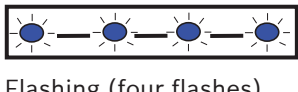
Flash pattern	Function
 On Steady	Indicates a good Input Power level.
 Flashing	Indicates a Input Power is low (brownout) or failure.
 Off	Is in an off state during the power up sequence.

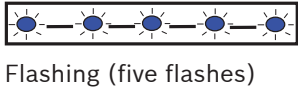
Table 7.9: POWER LED descriptions

BATTERY LED





Flash pattern	Function
 Off	Indicates normal operations.
 Flashing (one flash)	Indicates low battery voltage.
 Flashing (two flashes)	Indicates a missing battery (below 12.1 V).
 Flashing (three flashes)	Indicates a bad battery (low for 72 hours). Replace the battery with an new one.
 Flashing (four flashes)	Indicates a battery charger failure. Failure can only be cleared by powering down the module and rebooting. If the problem continues the module will require a board replacement.

Table 7.10: BATTERY LED descriptions

7.2 Show the firmware version

To show the firmware version using an LED flash pattern:

- If the optional tamper switch is installed:
- With the enclosure door open, activate the tamper switch.
- If the optional tamper switch is NOT installed:

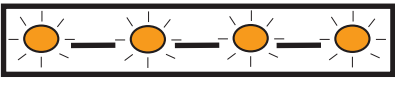
- Momentarily short the tamper pins.

When the tamper switch is activated (open to closed), the heartbeat LED stays Off for 3 sec before indicating the firmware version. The LED pulses the major, minor, and micro digits of the firmware version, with a 1 sec pause after each digit. The following is an example: The version 1.4.3 would show as LED flashes: [3 second pause] * _**** _*** [3 second pause, then normal operation].

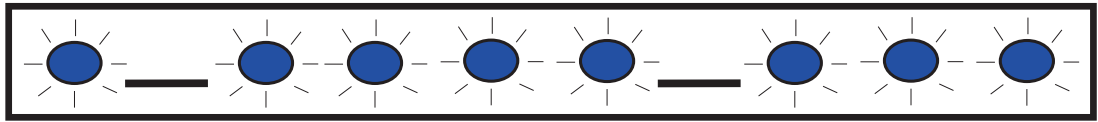

Figure 7.1: Firmware LED flash patterns example

7.3 Diagnostic log

The Diagnostic Log option is used in the event of an intermittent service outage, or communication error, in which a diagnostic log can be generated from the B465 menu options. The generated diagnostic log file is used by TECHNICAL SUPPORT to determine how often a persistent problem occurs, as well as detailed network configuration settings associated to the module during the time of the reported problem.

Generate the diagnostic log only when directed by TECHNICAL SUPPORT.

7.4 Understanding network polling

Plan carefully when programming the B465 supervision times, and D6x00 Receiver supervision time. Having the wrong or improper settings could cause trouble conditions when the network carrier performs maintenance, and increased network data traffic that could affect your monthly cost. Your settings for these parameters determine how the system works, but depend on the security level needed.

For more information regarding proper data plans and installation parameters related to network polling, refer to *Bosch Cellular Service User Guide* (P/N: F01U273558).

7.5 Troubleshooting procedures

Refer to the following section for troubleshooting hardware and software issues.

7.5.1 No power on the B465

Description:

The power wiring or power supply has a problem.

Solution:

1. Check the voltage at the Power input pins 16.5 VAC terminals on the B465. The voltage with a AC transformer attached should be between 16.5 VAC and 25 VAC depending on the loading. When using DC input, the voltage should be between 19 VDC and 29 VDC depending upon the loading.
2. Check the battery voltage when connected to the B465 . It should be between 10.2 VDC and 13.9 VDC.
3. If everything appears normal, replace the B465.

7.5.2 Initialization - cellular

Description:

STATUS LED double flashes until initialization is complete.

Solution:

1. If the device stays in this state for more than 120 seconds, reboot the system.
2. If the problem continues, verify with your service provider if cellular service for the selected service provider is available in your area, refer to *LED status indicators, page 75*.
3. If the problem continues, replace the B465.

7.5.3**Hardware****Description:**

General hardware problem.

Solution:

1. Reboot the system.
2. Check the wiring connections.
3. Check the voltage input for AC, if using the transformer, or DC if using the 24VDC from the control panel. AC = 16VAC to 25VAC DC = 19VDC to 29VDC
4. If the problem continues, replace the B465.

7.5.4**Firmware****Description:**

Corrupted flash or failed firmware upload.

Solution:

1. Perform the Reset to Factory Defaults procedure using the USB menu as described in *USB menu options, page 52.*, Maintenance => Reset to Factory Defaults option.
2. Upgrade the firmware as described in *Firmware Update page, page 71*.
3. If the problem continues, replace the B465.

7.5.5**SIM card****Description:**

SIM card problem. if you are experiencing problems with the SIM card. This is applicable to cellular communicators that have SIM cards (B442 and B443).

Solution:

1. Check for the presence of a SIM in the holder.
2. Install the SIM card and power up the module. Powering up Recognizes the SIM card.
3. Check for damage to the SIM card holder.
4. Remove and reseal the SIM card in the holder. Check to make sure the gold contact area on the SIM card is facing towards the board.
5. Reboot the system.
6. If the problem persists after rebooting the system, replace the SIM card. A new SIM card might require the B465 to be reconfigured to the new card's parameters (if using a different carrier or provider).

7.5.6**PIN code****Description:**

Mismatched PIN code.

Solution:

- If the SIM card's PIN is unknown, review the information on the SIM card holder that the card was delivered in for additional information.
- If the SIM card's PIN is known, set the B465 PIN to match your SIM PIN. Set the SIM PIN using the USB cellular menu under Advanced Communication Configuration (refer to *USB Main Menu, page 29*).

- If the problem continues after rebooting the system, replace the SIM card with a different card. A new SIM card might require the B465 to be reconfigured to the new card's parameters (if using a different carrier or provider).

7.5.7

Cellular network registration

Description:

The B465 is attempting to register on the cellular network. This issue occurs if the registration never occurred, and can last up to 8 minutes. After 8 minutes, the LEDs change to the double-flash Radio Registration state. This condition can also happen if only one tower is within RF range and it has an outage. The module continues to attempt to establish communications.

Solution:

1. Refer to *Wireless Reception Issues* if the signal strength is unacceptable.
2. Replace the SIM card with a known good test card. If the signal strength is acceptable confirm that the wireless service provider activated this account and the SIM card correctly.
3. If the problem continues, replace the B465.

7.5.8

USB COM port error

Description:

COM error occurs when trying to connect to the B465 using the USB serial program. The following screen shows.

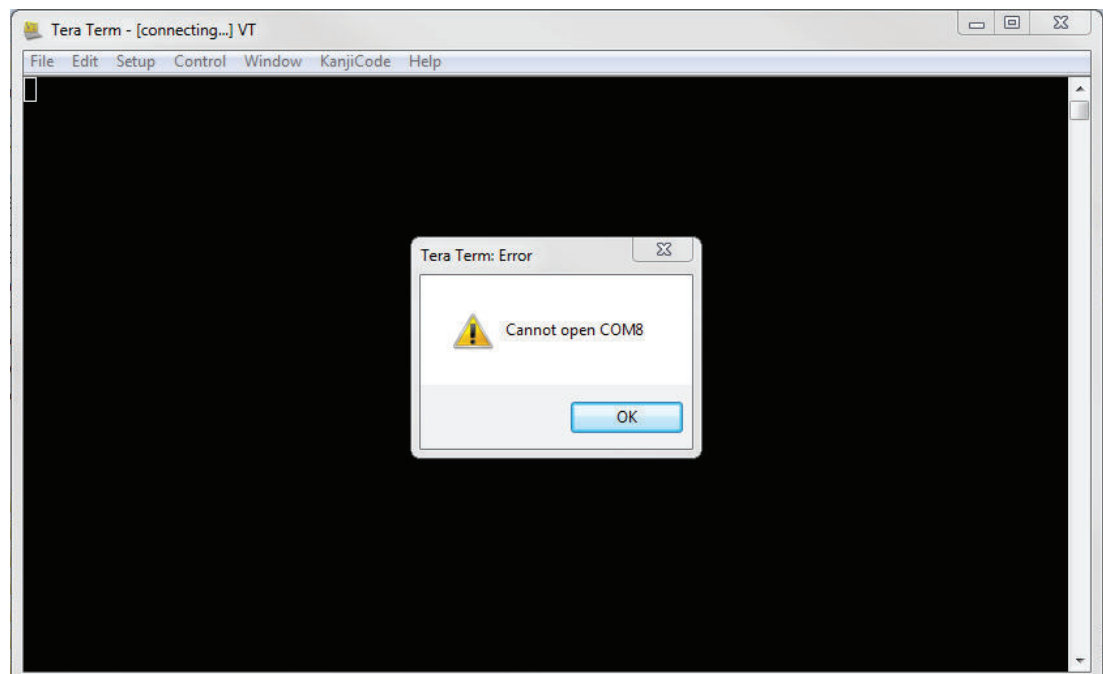
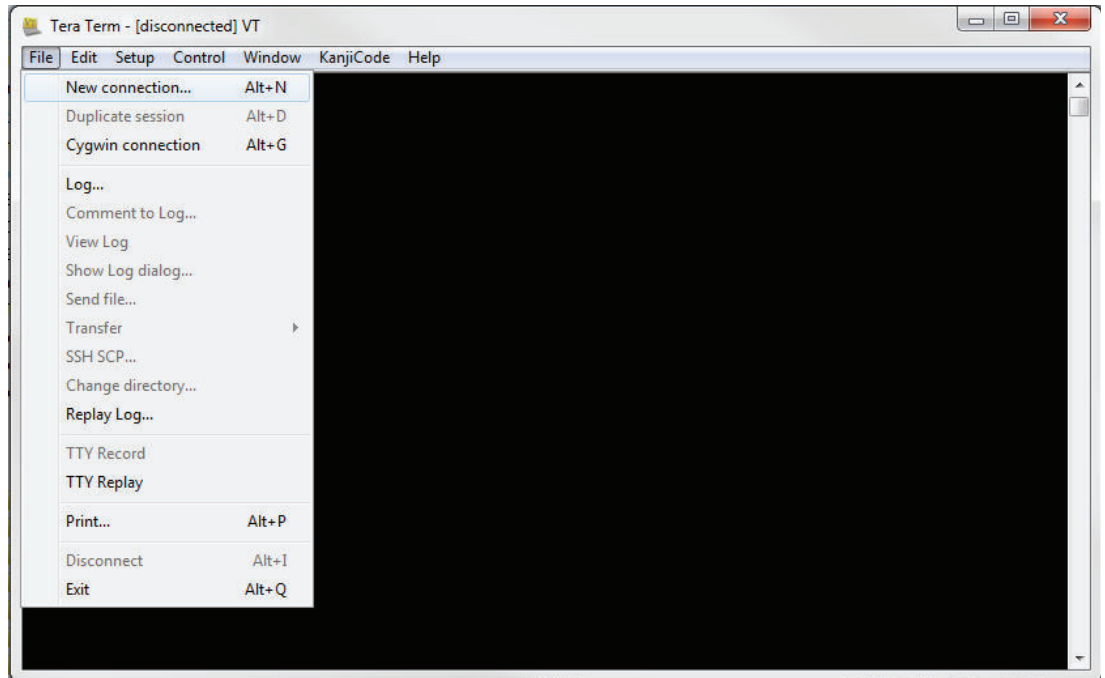

Figure 7.2: COM port error

Solution:

1. Press OK.
2. Press File -> New Connection.



3. Press the port that has the B465 Dual Path Communicator option.

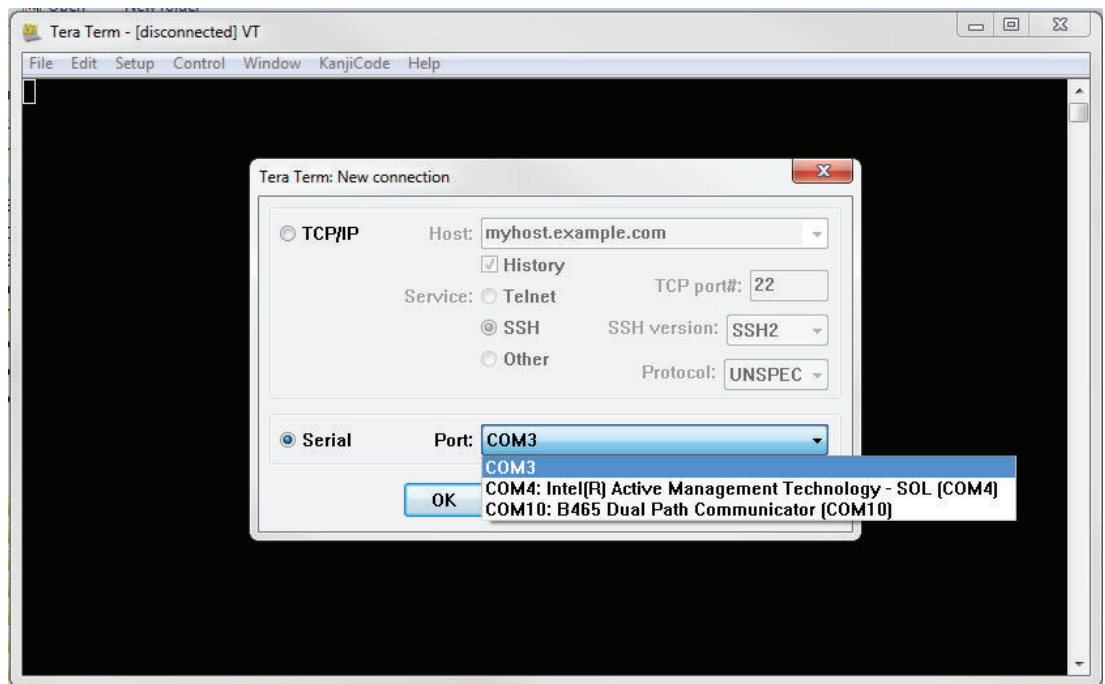

- 4. Press Ok.
- 5. Press the Enter key and login.

7.6 Testing the system

Test the system completely after installing and programming the B465. Test the B465, the control panel and all devices once a week for proper operation.



Notice!

After system installation and any B465 programming, perform a complete system test (UL 864 requirement). A complete system test includes testing the control panel, B465, all devices, and communication paths for proper operation.

8 Specifications and certifications

Refer to the following for specification and certification information.

8.1 Technical specifications

Environmental considerations

Relative humidity	Up to 93% non-condensing
Temperature (operating)	0° to +49° C (+32° to 120° F)

Properties

Dimensions (HxWxD)	79 mm x 128 mm x 38 mm (3.11 in x 5.03 in x 1.50 in)
--------------------	------------------------------------------------------

Wiring

USB cable	Use a Bosch supported Type A male-to-male USB cable such as the B99 cable (F01U278853).
-----------	-----------------------------------------------------------------------------------------

Compatible enclosures

B10R Medium Control Panel Enclosure – 35.6 cm x 31.8 cm x 7.6 cm (14 in x 12.5 in x 3 in)
B10 Medium Control Panel Enclosure – 35.6 cm x 31.8 cm x 7.6 cm (14 in x 12.5 in x 3 in)
B11R Small Control Panel Enclosure – 27.8 cm x 25.9 cm x 8.32 cm (10.9 in x 10.2 in x 3.3 in)
B11 Small Control Panel Enclosure – 27.8 cm x 25.9 cm x 8.32 cm (10.9 in x 10.2 in x 3.3 in)
D8103 Universal Enclosure – 41 cm x 41 cm x 9 cm (16 in x 16 in x 3.5 in)
B12 Mounting Plate for D8103 Enclosure – 23.5 cm x 21.92 cm x 1.27 cm (9.25 in x 8.63 in x 0.5 in)
D8108A Attack Resistant Enclosure – 41 cm x 41 cm x 9 cm (16 in x 16 in x 3.5 in)

Compatible transformers

D1640, 120 VAC input, 16.5 VAC, 40 VA output Class 2 plug-in
D1640-CA 120 VAC input, 16.5 VAC, 40 VA output Class 2 plug-in
D1640-120WI, 120 VAC input, 16.5 VAC, 40 VA output Class 2 wire-in

Compatible receivers

(Bosch) Conettix D6600 Communications Receiver/Gateway
(Bosch) Conettix D6100IPv6 Communications Receiver/Gateway
(Bosch) Conettix D6100i Communications Receiver/Gateway

Compatible PSTN input reporting formats

Ademco Contact ID (SIA DC-05) +10 digit account codes
Pulse 3/1, 3/1 Checksum (2300 Hz ACK Tone)
Pulse 3/1, 3/1 Checksum (1400 Hz ACK Tone)
Pulse 4/2 (2300 Hz ACK Tone)
Pulse 4/2 (1400 Hz ACK Tone)
SIA (SIA8, SIA 20) – 110 and 300 baud

Compatible cellular modules

B440 Conettix Plug-in Communicator, Cellular (3G)
B441 Conettix Plug-in CDMA Cellular Communicator
B442 Conettix Plug-in GPRS Cellular Communicator
B443 Conettix Plug-in HSPA+ Cellular Communicator (SIM card required)

8.1.1 B465 power supply specifications

Voltage input (power supply)	Primary	16.5 VAC terminals	16.5 VAC 40 VA Class 2 transformer (D1640/D1640-CA, D1640-120WI))
	Secondary	BAT terminals	12 Volt Sealed Lead Acid Rechargeable Battery (D126 or D1218)
Standby battery requirements	Battery input: B465 : Idle 150 mA; Alarm 230 mA Refer to the <i>Standby battery requirements and calculations</i> section in the B465 <i>Installation and Operation Guide</i> for the current draw requirements of other system components.		
24 VDC input current requirements	24 VDC input: B465 : Idle 120 mA; Alarm 160 mA Refer to the 24 VDC Input Power Refer to the <i>Standby battery requirements and calculations</i> section in the B465 <i>Installation and Operation Guide</i> for the current draw requirements of other system components.		
Power outputs	All external connections are power-limited. The battery terminals are not power limited.		
Ethernet connection (optional)	10BASE-T 100BASE-TX Maximum wiring distance: 100 m (328 ft) using cat 5e wire or better		
Battery discharge/recharge schedule	Discharge cycle	13.65 VDC - Charging float level. 12.1 VDC - Low Battery Report, if programmed. 10.2 VDC - Minimum operational voltage.	
	Recharge Cycle	AC ON - Battery charging begins and AC Restoral Reports sent. 13.4 V - Battery Restoral Report sent. Battery float charged.	
Environmental	Temperature	0°C to +49°C (+32°F to 122°F)	

	Relative Humidity	5% to 93% at +32°C (+90°F) non-condensing
Point thresholds	On-board points 1 to 4	Open - 3.7 to 5.0 VDC Normal - 2.0 to 3.0 VDC Short - 0.0 to 1.3 VDC Short circuit current – 2.5 mA

8.1.2 Application environment

Application	Minimum Required Standby Time (hr)	Minimum Alarm Time (min)
Residential Burglary	4	4
Proprietary Burglary	4	N/A
Central Station (Bank)	72	N/A
Central Station (Mercantile)	4	N/A
Police Station Connected (Bank)	72	30 (CUL)/15 (UL)
Police Station Connected (Mercantile)	24	30 (CUL)/15 (UL)
Local Burglary (Bank)	72	30 (CUL)/15 (UL)
Local Burglary (Mercantile)	24	30 (CUL)/15 (UL)
Commercial Fire	24	30 (CUL)/5 (UL)
Residential Fire	24	5 (CUL)/4 (UL)

Table 8.1: Minimum standby and alarm times

Notice!

UL Commercial Burglary Application Requirements



Mount the module in the B465 enclosure. If the unit is used in a commercial burglar environment, and is enclosed in a commercial enclosure, that enclosure must be tampered. The B465 must be mounted inside an attack resistant enclosure (D8108A) if the installation is a local or police station connection. For Commercial Burglary applications, house all communicators in tampered enclosures. You must wire system troubles back to the control panel as the B46 can not be used in the D8108A enclosure.

8.1.3 Standby battery requirements and calculations

Standby battery calculations

		B			C		
		Standby Power On Normal Current (mA)			Alarm Current (mA)		
Model Number	Qty Used	Each Unit	Qty	Total	Each Unit	Qty	Total
B465	1	150	x 1	= 150	230	x 1	= 230
B46	_____	23	x 1	= _____	23	x 1	= _____
B440	_____	35	x 1	= _____	150	x 1	= _____
B441	_____	35	x 1	= _____	150	x 1	= _____
B442	_____	35	x 1	= _____	150	x 1	= _____
B443	_____	35	x 1	= _____	150	x 1	= _____
Aux Power (0 – 500 mA)	_____	_____	x Qty	= _____	_____	x Qty	= _____
_____	_____	_____	x Qty	= _____	_____	x Qty	= _____
_____	_____	_____	x Qty	= _____	_____	x Qty	= _____
			Total B = _____		Total C = _____		

Table 8.2: Current rating chart for standby battery calculations



Notice!

Maximum power supply current for Total B in the table above is 705 mA, and the maximum power supply current for Total C is 900 mA.

Total B		Hours ¹		Total C		Alarm Operation ²		Contingency		Total Ah ³
(_____	x	_____	+	(_____	x	_____)	+	20%	=	_____
_____)								

¹ Refer to the *Application environment, page 89* table.

² Value = Minutes of alarm operation/60 as per the *Application environment, page 89* table.

³ Total Ah requirements must not exceed the Ah capacity of batteries:

- One D126 Battery = 7 Ah
- One D1218 Battery = 18 Ah

See also

- *Application environment, page 89*

8.1.4 24 VDC Input power requirements

24 VDC applied to power supply input terminals

		B			C		
		Standby Power On Normal Current (mA)			Alarm Current (mA)		
Model Number	Qty Used	Each Unit	Qty	Total	Each Unit	Qty	Total
B465	1	120	x 1	= 120	160	x 1	= 160
B46	_____	23	x 1	= _____	23	x 1	= _____
B440	_____	35	x 1	= _____	150	x 1	= _____
B441	_____	35	x 1	= _____	150	x 1	= _____
B442	_____	35	x 1	= _____	150	x 1	= _____
B443	_____	35	x 1	= _____	150	x 1	= _____
Aux Power (0 – 500 mA)	_____	_____	x Qty	= _____	_____	x Qty	= _____
_____	_____	_____	x Qty	= _____	_____	x Qty	= _____
_____	_____	_____	x Qty	= _____	_____	x Qty	= _____
			Total B = _____		Total C = _____		

Table 8.3: Current rating chart for standby calculations



Notice!

Maximum power supply current for Total B in the table above is 675 mA, and the maximum power supply current for Total C is 830 mA.

8.1.5 Required programming to meet UL 864

This section identifies the programming requirements you must make in order to comply with UL 864 Commercial Fire applications.



Notice!

NOTICE TO USERS, INSTALLERS, AUTHORITIES HAVING JURISDICTION, AND OTHER INVOLVED PARTIES. This product incorporates field-programmable software. In order for the product to comply with the requirements in the Standard for Control Units and Accessories for Fire Alarm Systems, UL 864, you must limit certain programming features or options to specific values.

Product feature/option	Permitted in UL 864? (Yes/No)	Possible settings	Settings permitted in UL 864
Input power source = AC	Yes	AC/DC	AC – when using transformer input
Input Power Fail Delay	Yes	0 to 255 minutes	60 to 180 minutes
Input Power Fail sends reports	Yes	Enabled/Disabled	Enabled – if sending report from B465, disabled if using relay outputs to control panel
Input Power Source = DC	Yes	AC/DC	DC – when powering from UL listed control panel or power supply
Input Power Fail Delay	Yes	0 to 255 minutes	0 to 3 minutes
Input Power Fail sends reports	Yes	Enabled/Disabled	Enabled – if sending report from B465, disabled if using relay outputs to control panel
Battery Monitoring	Yes	Enabled/Disabled	Enabled
Battery faults send reports	Yes	Enabled/Disabled	Enabled – if sending report from B465, disabled if using relay outputs to control panel
Ethernet/Cellular Supervision Time	Yes	No Supervision, 90 seconds, 180 seconds, 200 seconds, 300 seconds, 1 hour, 4 hours, 24 hours	4 hour supervision can be used when dual technologies are used. Sole path times depends on the NFPA standard being used, always consult your local AHJ. 90 seconds, 180 seconds, 200 seconds, 300 seconds, 1 hour

8.1.6

Required programming to meet ULC-S304

This section identifies the programming requirements you must make in order to comply with ULC-S304 Signal Receiving Centre and Premise Alarm Control Units.

Requirement	Parameter
Supervision interval for IP communications	Ethernet / Cellular Supervision Time = 180 seconds
Communicators are not suitable for active <i>communication channel (IP)</i> security and medium or high risk applications unless such can be “on line” at all times, have a minimum 128 bit encryption scheme, have encryption enabled, network and domain security implemented and are in compliance with Subsection 15.2, Active Communication Channel Security.	AES Encryption Enabled at 128, 192, or 256 bits
Mains power supply below 85% of rated supply shall be detected and transmitting to the receiving centre in not more than 3 hours	Input Power Fail Delay = 0 – 180 minutes
If the signal receiving centre equipment is completely duplicated with standby equipment and a switchover can be accomplished in not more than 90 seconds with no loss of signals during this period, the capacity of the system is unlimited otherwise it shall be limited to 1000 alarm systems connected to the receiving centre	No special parameters need to be set in the B465, verify with central station

8.1.7 Compatible UL listed components

	Household Burglary	Household Fire	Household Fire/Burglary Combined	Central Station Burglary	Police Connected Burglary	Holdup	Central Station Fire Combined	Central Station Fire/Burglary	Central Station Fire/Burglary Combined	Central Station Fire
Minimum hours of standby battery	4	24	24	4	4	8	24	24	24	24
B10 Medium Control Panel Enclosure	Opt.	Opt.	Opt.	Opt.	No.	Opt.	Opt	Opt	Opt	Opt
B10R Medium Control Panel Enclosure (Red)	Opt.	Opt.	Opt.	Opt.	No	Opt.	Opt	Opt	Opt	Opt

B11 Small Control Panel Enclosure	Opt.	Opt.	Opt.	Opt.	No	Opt.	Opt	Opt	Opt	Opt
B11R Small Control Panel Enclosure (Red)	Opt.	Opt.	Opt.	Opt.	No	Opt.	Opt	Opt	Opt	Opt
B440 Conettix Plug-in Cellular Communicator	Opt.	Opt.	Opt.	Opt.	Opt.	Opt.	Opt	Opt	Opt	Opt
B441 Conettix Plug-in Cellular Communicator	Opt.	Opt.	Opt.	Opt.	Opt.	Opt.	Opt	Opt	Opt	Opt
B442 Conettix Plug-in GPRS Cellular Communicator	Opt.	Opt.	Opt.	Opt.	Opt.	Opt.	Opt	Opt	Opt	Opt
B443 Conettix Plug-in Cellular Communicator	Opt.	Opt.	Opt.	Opt.	Opt.	Opt.	Opt	Opt	Opt	Opt
Conettix D6600 Communications Receiver/Gateway	N/A	N/A	N/A	Opt.	Opt.	N/A	Opt	Opt	Opt	Opt
Conettix D6100IPv6	N/A	N/A	N/A	Opt.	Opt.	N/A	Opt	Opt	Opt	Opt
Conettix D6100i Communications Receiver/Gateway	N/A	N/A	N/A	Opt.	Opt.	N/A	Opt	Opt	Opt	Opt
D1640 Plug-in Transformer (16.5 VAC 40 VA 60 Hz)	Opt.	Opt.	Opt.	Opt.	Opt.	Opt.	Opt	Opt	Opt	Opt
D1640-120WI Wired Transformer (16.5 VAC 40 VA 60 Hz)	Opt.	Opt.	Opt.	Opt.	Opt.	Opt	Opt	Opt	Opt	Opt
D1640-CA Plug-in Transformer (16.5 VAC 40 VA 60 Hz)	Opt.	Opt.	Opt.	Opt.	Opt.	Opt.	Opt	Opt	Opt	Opt

D8004 Transformer Enclosure	Opt.	Opt.	Opt.	Opt.	No	Opt.	Opt	Opt	Opt	Opt
D8103 Universal Enclosure	Opt.	Opt.	Opt.	Opt.	No	Opt	Opt	Opt	Opt	Opt
D8108A Attack Resistant Enclosure	Opt.	Opt.	Opt.	Opt.	Req	Opt.	Opt	Opt	Opt	Opt

Key	Description
No	Not acceptable for this application
Req.	Required for this application.
Opt.	Optional for this application.
1+	1 or more required for this application. Consult the appropriate standard.
* Not investigated by UL.	

CTN	Name	UL 864	UL 985	UL Intrusion	cUL
B10/B10R	Medium Control Panel Enclosure	x	x	x	x
B11/B11R	Small Control Panel Enclosure	x	x	x	x
B12	Mounting Plate for D8103 Enclosure	x	*x	*x	*x
D8103	Universal Control Panel Enclosure	x	x	x	x
D8108A	Attack Resistant Enclosure	x	x	x	x
D8004	Transformer Enclosure	*x			
D101	Lock and Key Set	x	x	x	x
B46	External Annunciator	x	x	x	x
B440	Conettix Plug-in Cellular Communicator	x	x	x	
B441	Conettix Plug-in Cellular Communicator	x	x	x	
B442	B442 Conettix Plug-in GPRS Cellular Communicator				
B443	B443 Conettix Plug-in HSPA+ Cellular Communicator	x	x	x	x
B520	Auxiliary Power Supply Module	x	x	x	x
D126	Battery (12.0 VDC, 7 Ah)	x	x	x	x
D1218	Battery (12 V, 18 Ah)	x	x	x	x
D1640	UL Listed Class 2 Plug-in Transformer 16.5 VAC 40 VA 60 Hz	x	x	x	
D1640-120WI	UL Listed Class 2 Wired Transformer 16.5 VAC 40 VA 60 Hz	x	x	x	x

CTN	Name	UL 864	UL 985	UL Intrusion	cUL
D1640-CA	UL Listed Class 2 Plug-in Transformer 120 VAC primary, 16.5 VAC 40 VA secondary				x
ICP-EZTS	Tamper Switch			x	x
*Required if using a plug-in transformer					

8.2 Certifications

Region	Certification
US	NIST FIPS 197
	FCC Part 15 Class B
	California State Fire Marshall (CSFM)
	UL 365 – Police Station Connected Burglar Alarm Units and Systems
	UL 609 – Local Burglar Alarm Units and Systems
	UL 864 – Control Units and Accessories for Fire Alarm Systems
	UL 985 – Household Fire Warning System Units
	UL 1023 – Household Burglar Alarm System Units
	UL 1076 – Proprietary Burglar Alarm Units and Systems
	UL 1610 – Central Station Burglar Alarm Units
Canada	CAN/ULC S303 – Local Burglar Alarm Units and Systems
	CAN/ULC S304 – Signal Receiving Centre and Premise Alarm Control Units
	ULC-545 – Residential Fire Warning Systems Control Units
	ULC-ORD-C1023 – Household Burglar Alarm System Units
	ULC-ORD-C1076 – Proprietary Burglar Alarm Units and Systems
	ICES-003 - Digital Apparatus

Bosch Security Systems, Inc.

130 Perinton Parkway

Fairport, NY 14450

USA

www.boschsecurity.com

© Bosch Security Systems, Inc., 2015

Bosch Sicherheitssysteme GmbH

Robert-Bosch-Ring 5

85630 Grasbrunn

Germany