



**DTK-UPS1000R DTK-UPS1000RE**  
**DTK-UPS1500R DTK-UPS1500RE**  
**DTK-UPS2000R DTK-UPS2000RE**  
**DTK-UPS3000R DTK-UPS3000RE**

On-Line  
Uninterruptible Power Supply  
Systems





# Table of Contents

1. Important Safety Warning .....	1
1-1. Transportation .....	1
1-2. Preparation .....	1
1-3. Installation .....	1
1-4. Operation .....	1
1-5. Maintenance, service and faults .....	2
2. Installation and setup .....	3
2-1 Rear panel view .....	3
2-2. Operating principle .....	4
2-3. Install the UPS .....	5
2-4. Setup the UPS .....	6
2-4 Battery Replacement .....	9
2-5 Battery Kit Assembly (option) .....	10
3. Operations .....	13
3-1. Button operation .....	13
3-2. LCD Panel .....	13
3-3. Audible Alarm .....	15
3-4. LCD display wordings index .....	15
3-5. UPS Setting .....	15
3-6. Operating Mode Description .....	18
3-7. Faults Reference Code .....	19
3-8. Warning indicator .....	20
4. Troubleshooting .....	21
5. Storage and Maintenance .....	23
6. Specifications .....	24
7. Warranty .....	26
8. Regulatory Compliance .....	27

# 1. Important Safety Warning

Please comply with all warnings and operating instructions in this manual. Save this manual and carefully read the following instructions before installing the unit. Do not operate this unit before thoroughly reading through all safety information and operating instructions.

## 1-1. Transportation

- Always remove the AC supply line, then disconnect the batteries before transporting.
- Please transport the UPS system only in the original package to protect against shock and impact.

## 2-2. Preparation

- Condensation may occur if the UPS system is moved directly from a cold to warm environment. The UPS system must be completely dry before installation. Please allow at least two hours for the UPS system to become acclimated to the environment.
- Do not install the UPS system near water or in moist environments.
- Do not install the UPS system where it would be exposed to direct sunlight or near a heater.
- Do not block ventilation holes in the UPS housing.

## 3-3. Installation

- Do not connect appliances or devices which would overload the UPS system (e.g. laser printers, heaters, air conditioners, etc.) to the UPS output sockets.
- Place cables in such a way that no one can step on or trip over them.
- Do not connect domestic appliances such as hair dryers to UPS output sockets.
- The UPS can be operated by any individuals with no previous experience.
- The UPS can be operated in TN and TT power distribution.
- Connect the UPS system only to an earthed shockproof outlet which must be easily accessible and close to the UPS system.
- Please use only UL-tested, UL-marked main cables to connect the UPS system to the building wiring outlet.
- Please use only UL-tested, UL-marked power cables to connect the loads to the UPS system.
- When installing the equipment, it should ensure that the sum of the leakage current of the UPS and the connected devices does not exceed 3.5mA.
- Temperature Rating - Units are considered acceptable for use in a maximum ambient of 40°C (104°F).
- For PLUGGABLE EQUIPMENT, the socket-outlet shall be installed near the equipment and shall be easily accessible.
- CAUTION: The unit is heavy. Lifting the unit requires a minimum of two people.

## 4-4. Operation

- Do not disconnect the main power cable on the UPS system or the AC outlet during operation, as this will disconnect grounding to UPS and connected devices.
- The UPS system features its own, internal current source (batteries). The UPS output sockets or output terminal blocks may be electrically live even if the UPS system is not connected to the building wiring outlet.

- In order to fully disconnect the UPS system, first press the OFF/Enter button to disconnect the mains.
- Do not allow fluids or other foreign objects inside the UPS system.
- The EPO, RS-232 and USB circuits are an IEC 60950 safety extra low voltage (SELV) circuit. This circuit must be separated from any hazardous voltage circuits by reinforced insulation.

### 1-5. Maintenance, service and faults

- The UPS system operates with hazardous voltages. Repairs may be carried out only by qualified maintenance personnel.
- **Caution** - risk of electric shock. Even after the unit is disconnected from the electrical outlet, components inside the UPS system are still connected to the battery and electrically live and dangerous.
- Before carrying out any kind of service and/or maintenance, disconnect the batteries and verify that no current is present and no hazardous voltage exists in the terminals and capacitors.
- To avoid electrical shock, turn off the unit and unplug it from the AC power source before servicing the battery
- Only persons who are familiar with batteries and required precautionary measures may replace batteries or supervise operations. Unauthorized persons must be kept well away from the batteries.
- **Caution** - risk of electric shock. The battery circuit is not isolated from the input voltage. Hazardous voltages may occur between the battery terminals and the ground. Before touching, please verify that no voltage is present.
- When changing batteries, install the same number and same type of batteries.
- Do not attempt to dispose of batteries by burning them. This could cause the battery to explode.
- Do not open or destroy batteries. Escaping chemicals may cause injury to the skin and eyes. It may be toxic.

#### Typical Installed/Replacement Batteries

Manufacturer	Type	Rated
CSB Battery Co Ltd (MH14533)	UPS 12460 F2FR	12 V dc, 9.0 Ah

Actual battery specs are subject to change.

- Do not dismantle the UPS system.
- A battery can present a risk of electrical shock and high short-circuit current. The following precautions should be observed when working on batteries:
  - a) Remove watches, rings, or other metal objects.
  - b) Use tools with insulated handles.
  - c) Wear rubber gloves and boots.
  - d) Do not lay tools or metal parts on top of batteries.
  - e) Disconnect charging source prior to connecting or disconnecting battery terminals.
  - f) Determine if battery is inadvertently grounded. If inadvertently grounded, remove source from ground. Contact with any part of a grounded battery can result in electrical shock. The likelihood of such shock can be reduced if such grounds are removed during installation and maintenance.

## 2. Installation and setup

**NOTE:** Before installation, please inspect the unit. Be sure that nothing inside the package is damaged. Please keep the original package in a safe place for future use.

### 2-1 Rear panel view

**DTK-UPS1000R**  
**DTK-UPS1000RE**  
**DTK-UPS1500R**  
**DTK-UPS1500RE**

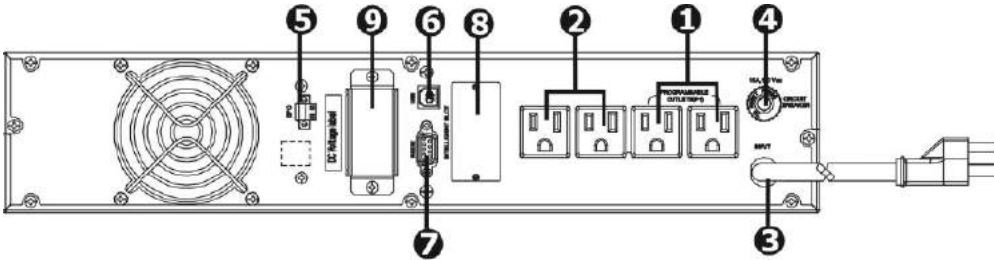

**DTK-UPS2000R**  
**DTK-UPS2000RE**

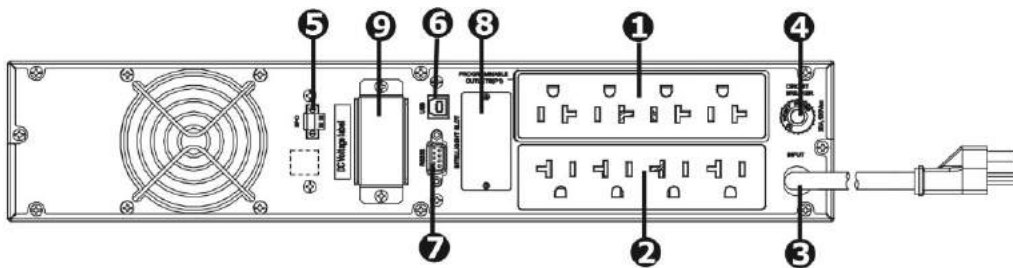

**DTK-UPS3000R**  
**DTK-UPS3000RE**

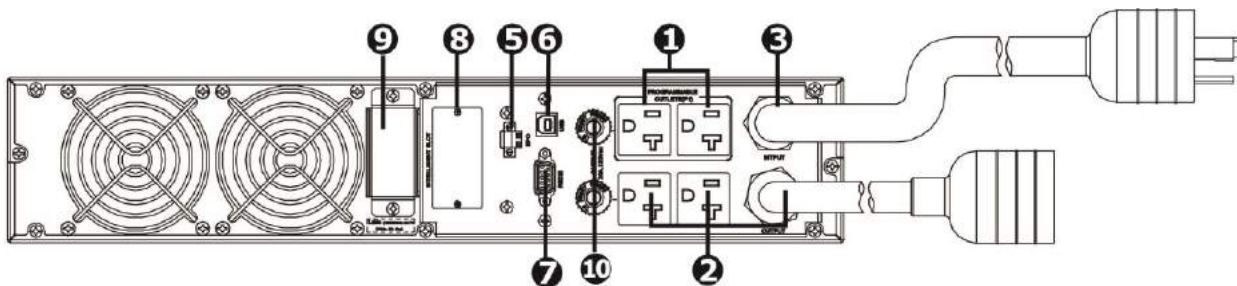

1. Programmable outlets: connect to non-critical loads.
2. Output receptacles: connect to mission-critical loads.
3. AC input
4. Input circuit breaker
5. Emergency power off function connector (EPO)
6. USB communication port
7. RS-232 communication port
8. SNMP intelligent slot
9. External battery connector (only available for long-run models)
10. Output circuit breaker(s)

## 2-2. Operating principle

The operating principle of the UPS is shown as below

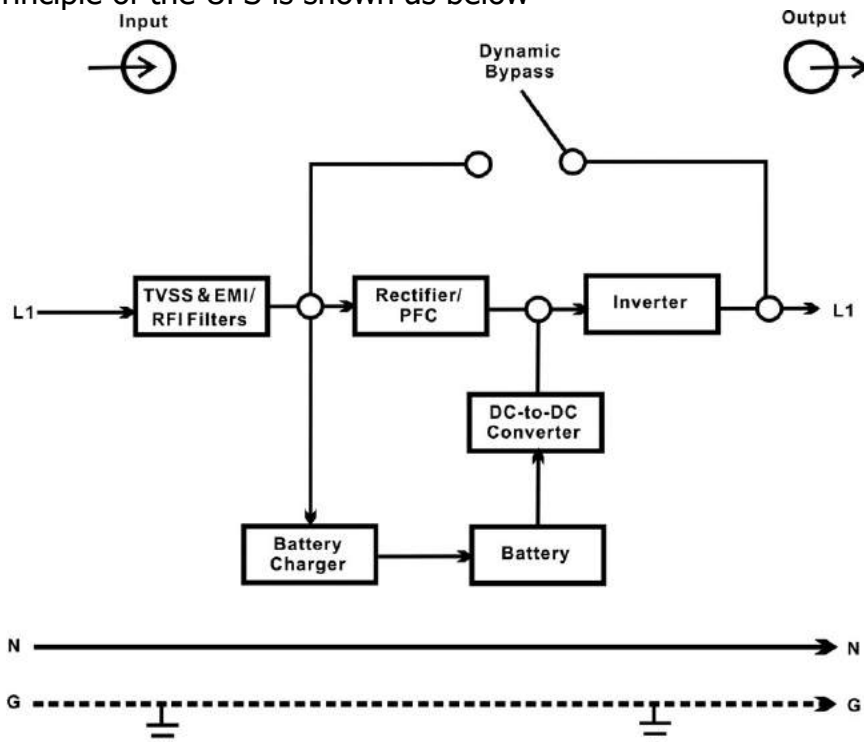

The UPS is composed of mains input, TVSS and EMI/RFI filters, rectifier/PFC, inverter, battery charger, DC-to-DC converter, battery, dynamic bypass and UPS output.

### 2-3. Install the UPS

For safety consideration, the UPS is shipped out from factory without connecting battery wires. Before installing the UPS, please follow steps below to connect batteries.

#### Step 1

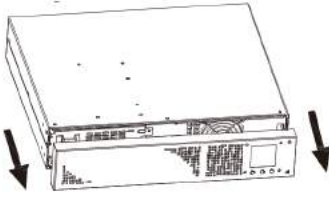

Remove front panel.

#### Step 2

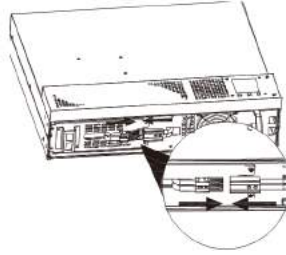

Remove battery panel and connect battery wire.

#### Step 3

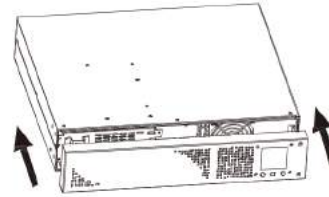

Put battery panel and cover back on the unit.

This UPS can be either displayed on the desk or mounted in the 19" rack chassis. Please choose proper installation to position this UPS.

### Rack-mount Installation

CAUTION – Do NOT use the mounting brackets to lift the unit. The mounting brackets are only for securing the unit to the rack.

#### Install UPS alone

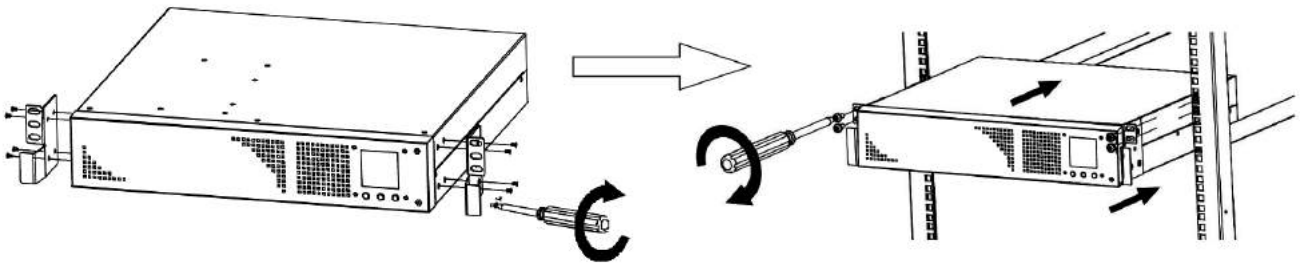

#### Install UPS and external battery

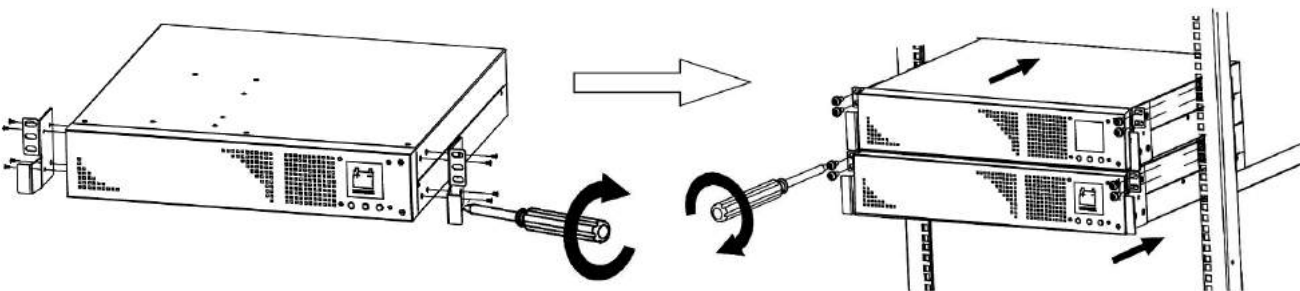



## Tower Installation

### Install UPS alone

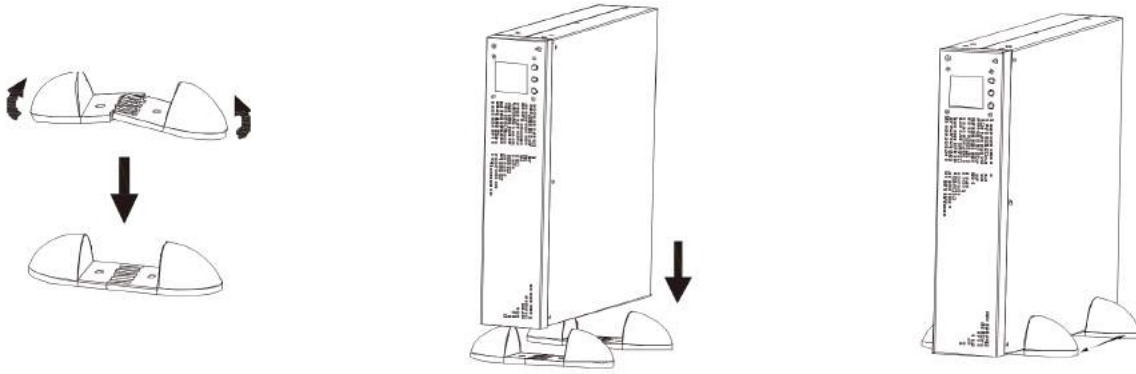

### Install UPS and external battery

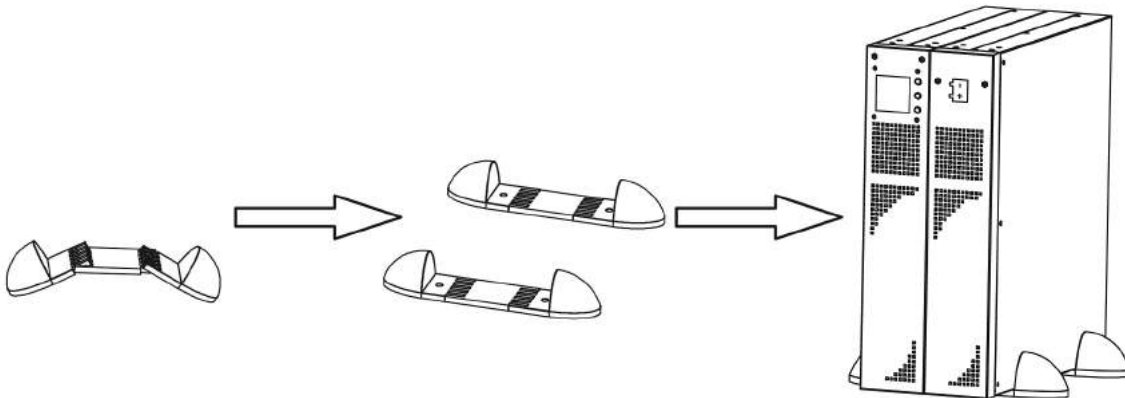

**NOTE:** When installing the UPS or battery pack with feet, please keep 70mm distance from the edge of the unit.

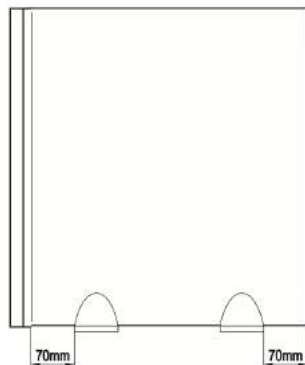

## 2-4. Configure the UPS

### Step 1: UPS input connection

Plug the UPS into a two-pole, three-wire, grounded receptacle only. Avoid using extension cords.

**CAUTION:** For 1000VA models, to reduce the risk of fire, connect only to a circuit provided with 15 amperes maximum branch circuit overcurrent protection in accordance with the National Electric Code, ANSI/NFPA 70.

**CAUTION:** For 2000VA models, to reduce the risk of fire, connect only to a circuit provided with 20 amperes maximum branch circuit overcurrent protection in accordance with the National Electric Code, ANSI/NFPA 70.

**CAUTION:** For 3000VA models, to reduce the risk of fire, connect only to a circuit provided with 30 amperes maximum branch circuit overcurrent protection in accordance with the National Electric Code, ANSI/NFPA 70.

### Step 2: UPS output connection

There two kinds of outputs: programmable outlets and general outlets. Please connect non-critical devices to the programmable outlets and critical devices to the general outlets. During power failure, you may extend the backup time to critical devices by setting shorter backup time for non-critical devices.

### Step 3: Communication connection

#### Communication port:

##### USB port



##### RS-232 port

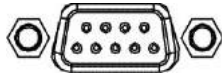

##### Intelligent slot



To allow for unattended UPS shutdown/start-up and status monitoring, connect the communication cable one end to the USB/RS-232 port and the other to the communication port of your PC. With the monitoring software installed, you can schedule UPS shutdown/start-up and monitor UPS status through PC.

***USB port and RS-232 port cannot be used at the same time.***

The UPS is equipped with intelligent slot for SNMP. The SNMP card provides advanced communication and monitoring options.

***Models ending in (E) have SNMP card pre-installed.***

### Step 4: Disable and enable EPO function

Keep the pin 1 and pin 2 closed for UPS normal operation. To activate EPO function, cut the wire between pin 1 and pin 2.

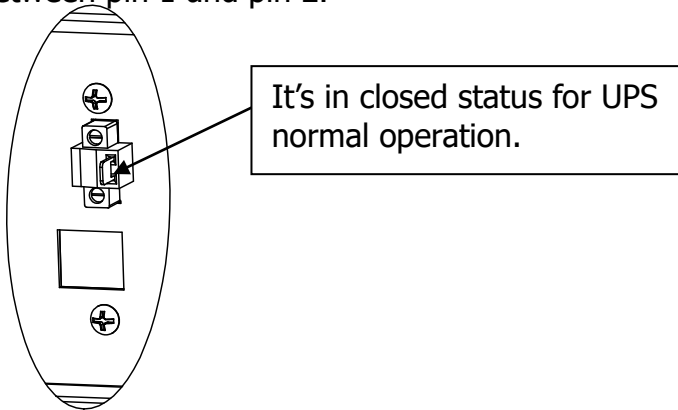

### Step 5: External battery connection

Connect one end of external battery cable to UPS unit and the other end to battery pack. See below chart for detailed connection.

**CAUTION:** Connection to External Battery shall be installed by SERVICE PERSONNEL only.

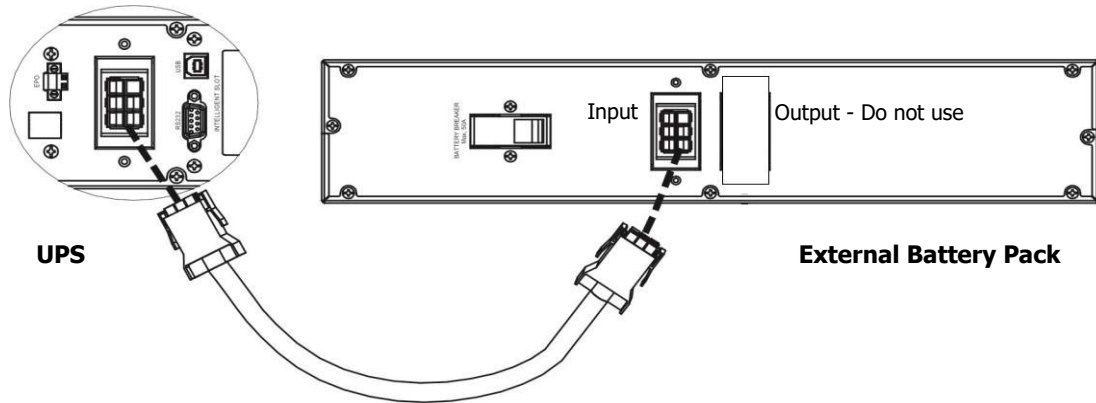

**CAUTION:** Risk of fire hazard, UPS can be used with only one External Battery Pack.

Model	Rating
DTK-UPS3000R(E)	I/P: 100-120 V, 50/60 Hz, 24 A O/P: 100 V ac, 24.0 A, 2400 VA, 2160 W 110 V ac, 24.5 A, 2700 VA, 2430 W 115 V ac, 24.8 A, 2850 VA, 2565 W 120 V ac, 25.0 A, 3000 VA, 2700 W 50/60 Hz
DTK-UPS2000R(E)	I/P: 100-120 V, 50/60 Hz, 16 A O/P: 100 Vac, 16.0 A, 1600 VA, 1440 W 110 Vac, 16.4 A, 1800 VA, 1620 W 115 Vac, 16.5 A, 1900 VA, 1710 W 120 Vac, 16.7 A, 2000 VA, 1800 W 50/60 Hz
DTK-UPS1500R(E)	I/P: 100-120 V, 50/60 Hz, 12 A O/P: 100 Vac, 12 A, 1200 VA, 1080 W 110 Vac, 12.3 A, 1350 VA, 1215 W 115 Vac, 12.4 A, 1425 VA, 1283 W 120 Vac, 12.5 A, 1500 VA, 1350 W 50/60 Hz
DTK-UPS1000R(E)	I/P: 100-120 V, 50/60 Hz, 9.1 A O/P: 100 Vac, 8.0 A, 800 VA, 720 W 110 Vac, 8.2 A, 900 VA, 810 W 115 Vac, 8.3 A, 950 VA, 855 W 120 Vac, 8.3 A, 1000 VA, 900 W 50/60 Hz

## Step 6: Turn on the UPS

Press the ON/Mute button on the front panel for two seconds to power on the UPS.

Note: The battery charges fully during the first five hours of normal operation. Do not expect full battery run capability during this initial charge period.

## Step 7: Install software

For optimal computer system protection, install UPS monitoring software to fully configure UPS shutdown. Please follow steps below to download and install monitoring software:

1. Go to the website <http://www.diteksurgeprotection.com/ups-software>
2. Click ViewPower software icon and then choose your required OS to download the software.
3. Follow the on-screen instructions to install the software.
4. When your computer restarts, the monitoring software will appear as an orange plug icon located in the system tray, near the clock.

## 2-5. Battery Replacement (Service person only)

**NOTICE:** This UPS is equipped with internal batteries. Batteries should be replaced only by qualified service personnel.

**CAUTION!!** Consider all warnings, cautions, and notes before replacing batteries.

**Note:** Upon battery disconnection, equipment is not protected from power outages.

### Step 1

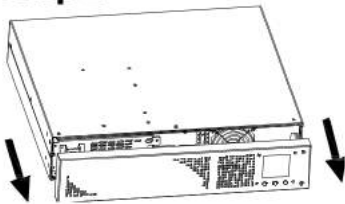

Remove front panel.

### Step 2

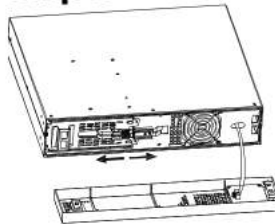

Disconnect battery wire and remove battery panel.

### Step 3

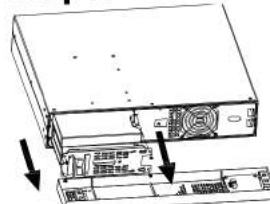

Pull out the battery box.

### Step 4

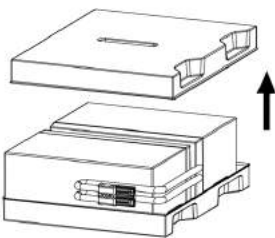

Remove the top cover of battery box and replace the inside batteries.

### Step 5

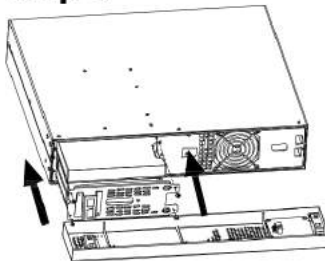

After replacing the batteries, put the battery box back to original location and screw it tightly.

### Step 6

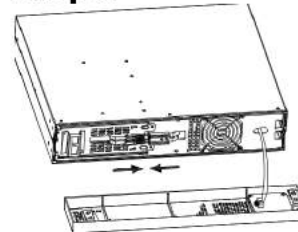

Re-connect the battery wire and screw battery panel back to the unit.

### Step 7

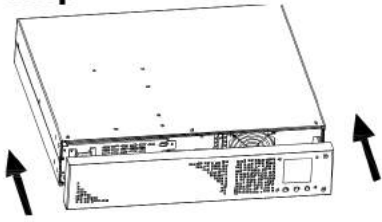

Put the front panel back to the unit.

## 2-6. Battery Kit Assembly (option)

**NOTICE:** Please assemble battery kit first before installing it inside of UPS. Please select correct battery kit procedure below to assemble it.

### 2-battery kit

Step 1: Remove adhesive tapes.

Tapes

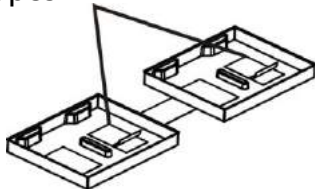

Step 3: Put assembled battery packs on one side of plastic shells.

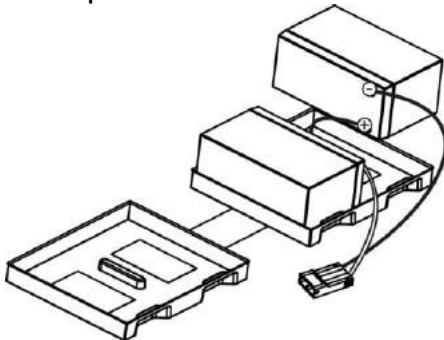

Step 2: Connect all battery terminals by following below chart.

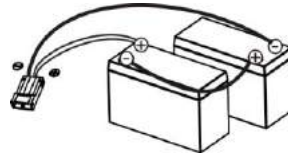

Step 4: Cover the other side of plastic shell as below chart. Install kit in UPS.

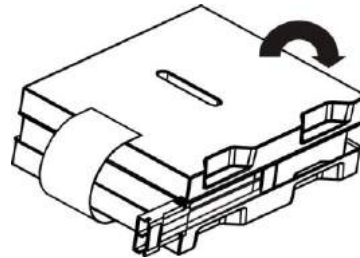

### 3-battery kit

Step 1: Remove adhesive tapes.

Tapes

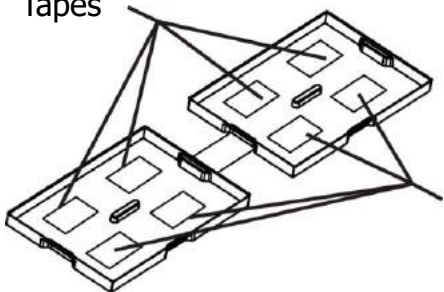

Tapes

Step 2: Connect all battery terminals by following below chart.

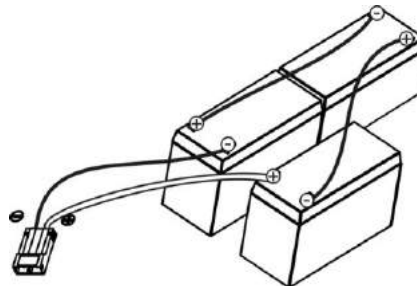

Step 3: Put assembled battery packs on one side of plastic shells and insert one defective battery for proper spacing.

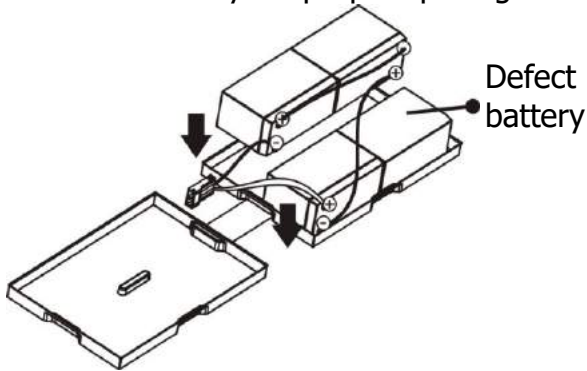

Step 4: Cover the other side of plastic shell as below chart. Install kit in UPS.

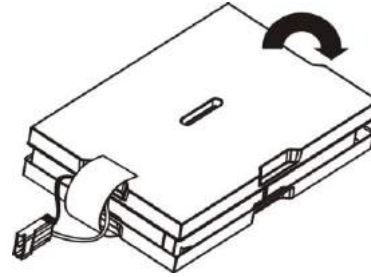

**4-battery kit**

Step 1: Remove adhesive tapes.

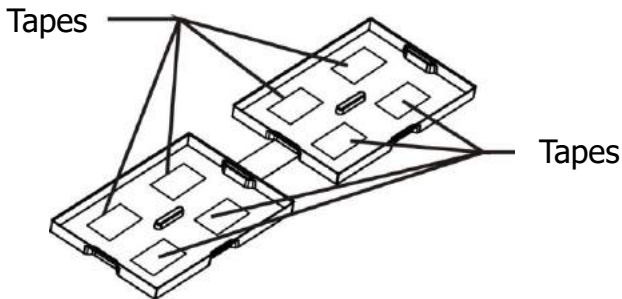

Step 2: Connect all battery terminals by following below chart.

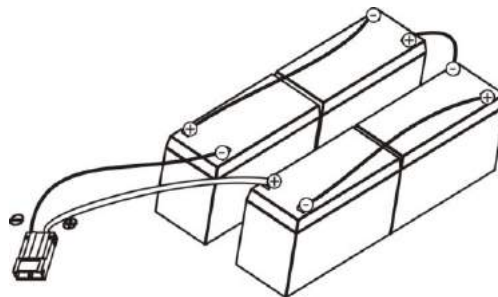

Step 3: Put assembled battery packs on one side of plastic shells.

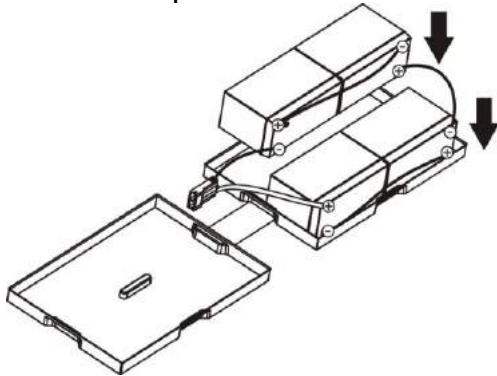

Step 4: Cover the other side of plastic shell as below chart. Install kit in UPS.

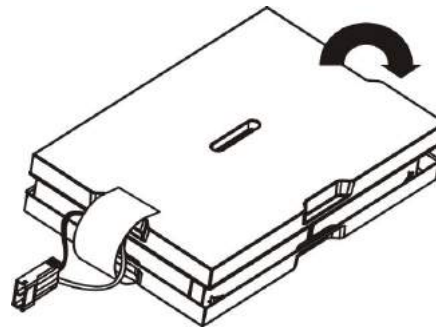

**6-battery kit**

Step 1: Remove adhesive tapes.

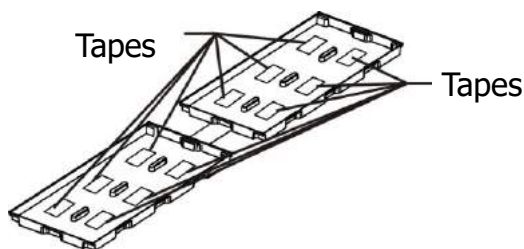

Step 2: Connect all battery terminals by following below chart.

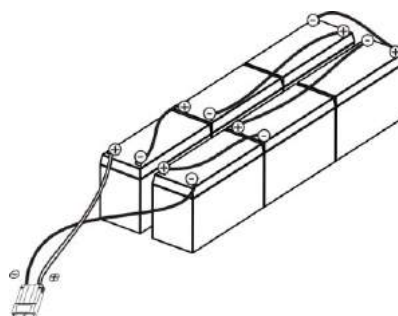

Step 3: Put assembled battery packs on one side of plastic shells.

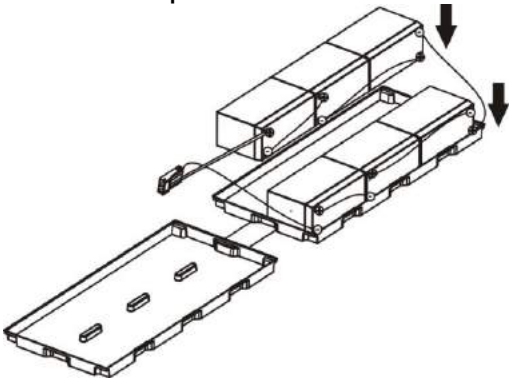

Step 4: Cover the other side of plastic shell as below chart. Install kit in UPS.

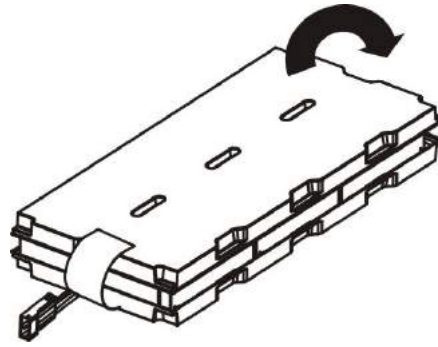

## 3. Operations

### 3-1. Button operation

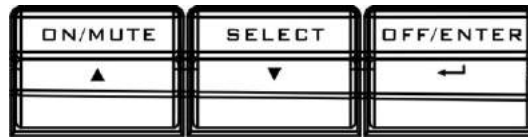

Button View

Button	Function
ON/Mute Button	<ul style="list-style-type: none"> <li>➤ Turn on the UPS: Press and hold ON/Mute button for at least 2 seconds to turn on the UPS.</li> <li>➤ Mute the alarm: After the UPS is turned on in battery mode, press and hold this button for at least 5 seconds to disable or enable the alarm system. But it's not applied to the situations when warnings or errors occur.</li> <li>➤ Up key: Press this button to display previous selection in UPS setting mode.</li> <li>➤ Switch to UPS self-test mode: Press ON/Mute buttons for 5 seconds to enter UPS self-testing while in AC mode, ECO mode, AECO mode, or converter mode.</li> </ul>
OFF/Enter Button	<ul style="list-style-type: none"> <li>➤ Turn off the UPS: Press and hold this button at least 2 seconds to turn off the UPS. If bypass setting is enabled, UPS will transfer to bypass mode when utility is normal. Otherwise, the UPS will transfer to standby mode.</li> <li>➤ Confirm selection key: Press this button to confirm selection in UPS setting mode.</li> </ul>
Select Button	<ul style="list-style-type: none"> <li>➤ Switch LCD message: Press this button to change the LCD message for input voltage, input frequency, battery voltage, output voltage, output frequency.</li> <li>➤ Setting mode: Press and hold this button for 5 seconds to enter UPS setting mode when Standby and Bypass mode.</li> <li>➤ Down key: Press this button to display next selection in UPS setting mode.</li> </ul>
ON/Mute + Select Button	<ul style="list-style-type: none"> <li>➤ Switch to bypass mode: When the main power is normal, press ON/Mute and Select buttons simultaneously for 5 seconds. Then UPS will enter to bypass mode. This action will be ineffective when the input voltage is out of acceptable range.</li> </ul>

### 3-2. LCD Panel



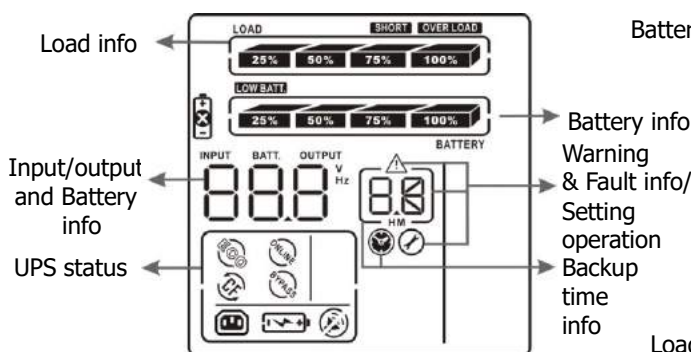



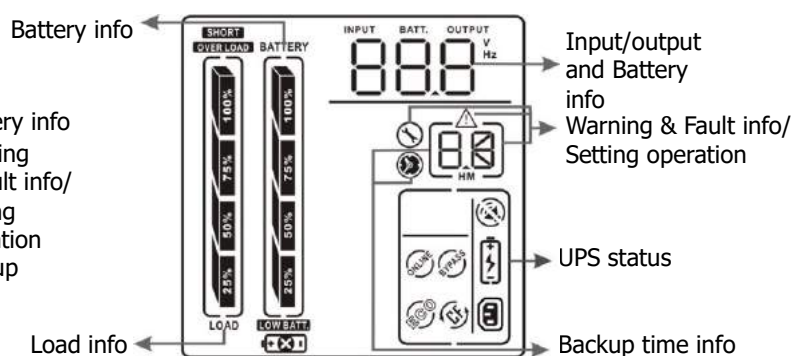











#### Rack Display



#### Tower Display





Display	Function
<b>Backup time information</b>	
	Indicates the backup time in pie chart.
	Indicates the backup time in numbers. H: hours, M: minute
<b>Warning &amp; Fault information</b>	
	Indicates that the warning and fault occurs.
	Indicates the warning and fault codes, and the codes are listed in details in 3-7 and 3-8 sections.
<b>Setting Operation</b>	
	Indicates the setting operation.
<b>Input/Output &amp; Battery information</b>	
	Indicates the output/input voltage, output/input frequency, and battery voltage. V: voltage, Hz: frequency
<b>Load information</b>	
	Indicates the load level by 0-25%, 26-50%, 51-75%, and 76-100%.
	Indicates overload.
	Indicates the load or the UPS output is short circuited.
<b>UPS status</b>	
	Indicates that programmable management outlets are working.
	Indicates the UPS is working in line mode.
	Indicates the UPS is working in converter mode.
	Indicates the UPS is working in bypass mode.
	Indicates the UPS powers the output directly from the mains
	Indicates that the UPS alarm is disabled.
	Indicates the battery charger is working.
<b>Battery information</b>	
	Indicates the Battery level by 0-25%, 26-50%, 51-75%, and 76-100%.
	Indicates low battery.
	Indicates there is something wrong with battery.

### 3-3. Audible Alarm

Battery Mode	Sounding every 4 seconds
Low Battery	Sounding every second
Overload	Sounding twice every second
Fault	Continuously sounding

### 3-4. LCD display wordings index

Abbreviation	Display content	Meaning
ENA	ENA	Enable
DIS	DIS	Disable
ESC	ESC	Escape
RAC	RAC	Rack display
TOE	TOE	Tower display
B.L	bL	Low Battery
O.L	OL	Overload
N.C	NC	Battery is not connected
O.C	OC	Overcharge
SF	SF	Site Fault
E.P	EP	EPO
T.P	TP	Over Temperature
C.H	CH	Charger Failure
B.B	bb	Battery Fault
F.U	FU	Frequency Unstable in Bypass Mode
B.V	bV	Input Voltage is Out of Bypass Range
E.E	EE	EEPROM error

### 3-5. UPS Setting

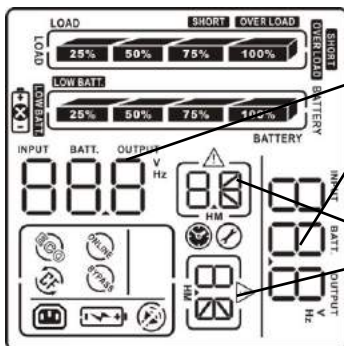

Parameter 2

Parameter 1

There are two parameters to set up the UPS.

Parameter 1: It's for program alternatives.

Parameter 2: It's for setting information display.

● 01: Output voltage setting

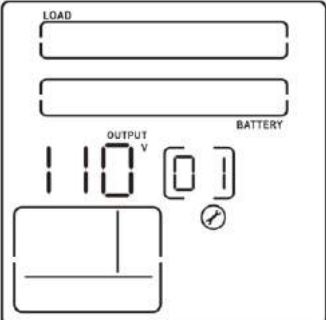
Interface	Setting
	<p>You may choose the following output voltage:</p> <p>100: presents output voltage is 100Vac            110: presents output voltage is 110Vac            115: presents output voltage is 115Vac            120: presents output voltage is 120Vac</p>

● 02: Frequency Converter enable/disable

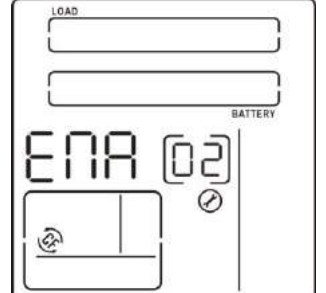
Interface	Setting
	<p>CF ENA: converter mode enable            CF DIS: converter mode disable</p>

● 03: Output frequency setting

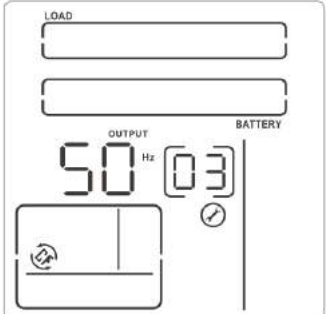
Interface	Setting
	<p>You may set the initial frequency on battery mode:</p> <p>BAT 50: presents output frequency is 50Hz            BAT 60: presents output frequency is 60Hz</p> <p>If converter mode enable, you may choose the following output frequency:</p> <p>CF 50: presents output frequency is 50Hz            CF 60: presents output frequency is 60Hz</p>

● 04: ECO enable/disable

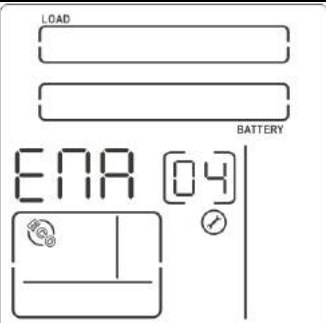
Interface	Setting
	<p>ENA: ECO mode enable            DIS: ECO mode disable</p>

- 05: AECO enable/disable

Interface	Setting
	ENA: Advanced ECO mode enable DIS: Advanced ECO mode disable

- 06: Bypass mode enable/disable when UPS is off

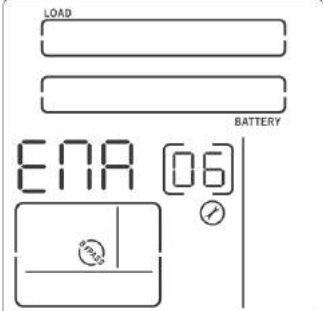
Interface	Setting
	ENA: Bypass mode is enabled when UPS is off DIS: Bypass mode is disabled when UPS is off.

- 07: Programmable outlets enable/disable

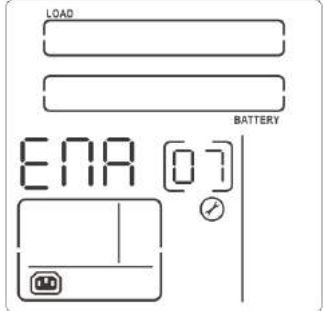
Interface	Setting
	ENA: Programmable outlets enable DIS: Programmable outlets disable

- 08: Programmable outlets setting

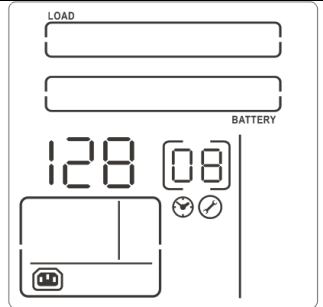
Interface	Setting
	0-999: setting the backup time limits in minutes from 0-999 for programmable outlets which connect to non-critical devices on battery mode.

- 09: LCD display direction setting

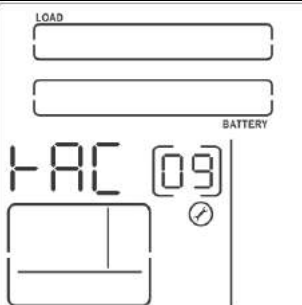
Interface	Setting
	RAC: the LCD display is horizontal. TOE: the LCD display is vertical.

- 10: Acceptable input voltage range setting

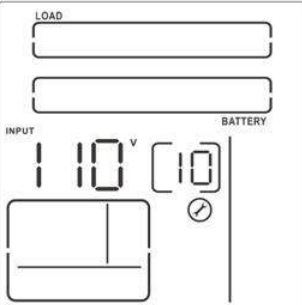
Interface	Setting
	You may choose the following Acceptable input voltage range: 55/150 alternating flashing: acceptable input voltage range is from 55V to 150V; 80/130 alternating flashing: acceptable input voltage range is 80V to 130V; 85/135 alternating flashing: acceptable input voltage range is 85V to 135V;

- 00: Exit setting

### 3-6. Operating Mode Description

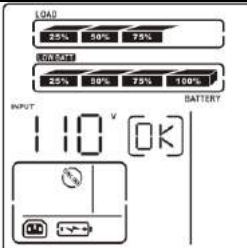
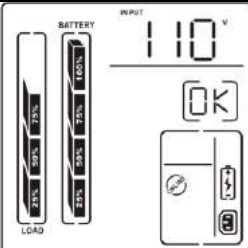
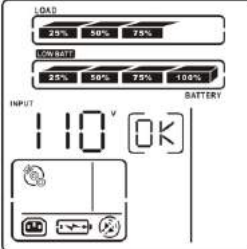
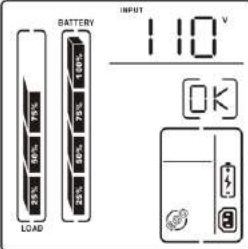
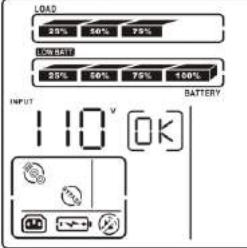
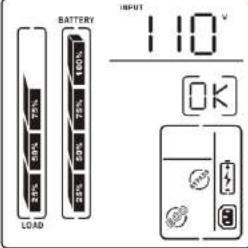

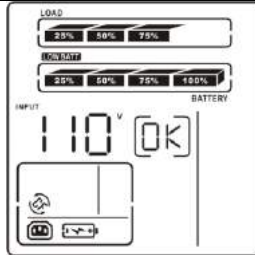
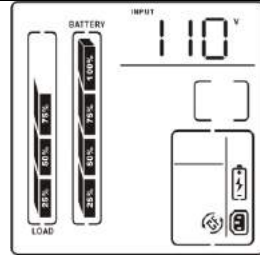
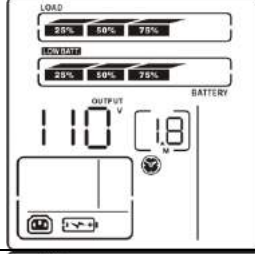
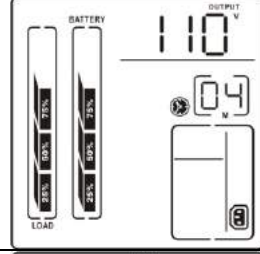
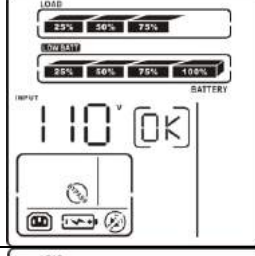
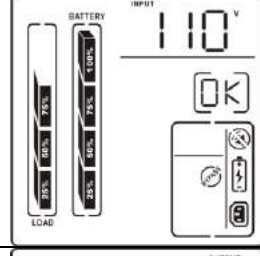
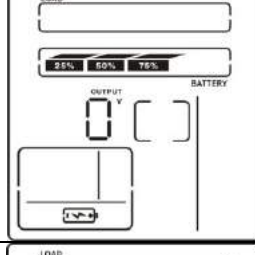
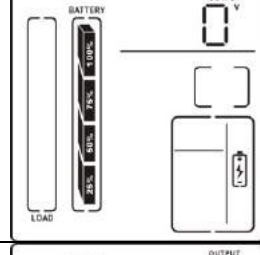
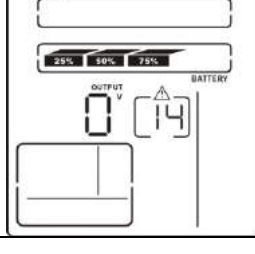
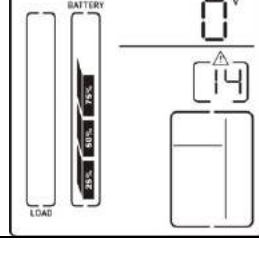









Operating mode	Description	LCD display	
		Rack Display	Tower Display
Online mode	When the input voltage is within acceptable range, UPS will provide pure and stable AC power to output. The UPS will also charge the battery at online mode.		
ECO mode (Efficiency Corrective Optimizer)	When the input voltage is within setting range ( $\pm 3\%V_o$ max), UPS will bypass voltage to output for energy saving. PFC and INVERTER are still active at this mode.		
AECO mode (Advanced Efficiency Corrective Optimizer)	When the input voltage is within setting range ( $\pm 3\%V_o$ max), UPS will bypass voltage to output for energy saving. PFC and INVERTER are off at this mode.		

Frequency Converter mode (Rack)	When input frequency is within 40 Hz to 70 Hz, the UPS can be set at a constant output frequency, 50 Hz or 60 Hz. The UPS will still charge battery under this mode.		
Battery mode	When the input voltage is beyond the acceptable range or power failure and alarm is sounding every 4 seconds, UPS will backup power from battery.		
Bypass mode	When input voltage is within acceptable range but UPS is overload, UPS will enter bypass mode or bypass mode can be set by front panel. Alarm is sounding every 10 seconds.		
Standby mode	UPS is powered off without output power, but the battery still can be charged.		
Fault mode	The UPS is in fault mode when no output power is supplied from the UPS and the fault icon flashes on the LCD display, although the information of UPS can be displayed in the screen.		

### 3-7. Faults Reference Code







Fault event	Fault code	Icon	Fault event	Fault code	Icon
Bus start fail	01	x	Low Inverter voltage	13	x
Bus over	02	x	Inverter output short	14	<b>SHORT</b>
Bus under	03	x	Battery voltage too high	27	x
Bus unbalance	04	x	Battery voltage too low	28	
Bus short circuited	05	x	Over temperature	41	x
Inverter soft start fail	11	x	Overload	43	<b>OVER LOAD</b>
High Inverter voltage	12	x			

### 3-8. Warning indicator

Warning	Icon (flashing)	Code	Alarm
Low Battery		bL	Sounding every second
Overload		OL	Sounding twice every second
Battery is not connected		NC	Sounding every second
Overcharge		OC	Sounding every second
Site wiring fault		SF	Sounding every second
EPO enable		EP	Sounding every second
Over temperature		EP	Sounding every second
Charger failure		CH	Sounding every second
Battery Fault		b.b	Sounding every second
Bypass Out Range		b.U	Sounding every second
Bypass Frequency Unstable		F.U	Sounding every second
EEPROM error		EE	Sounding every second

## 4. Troubleshooting

If the UPS system does not operate correctly, please solve the problem by using the table below.

Symptom	Possible cause	Remedy
No indication and alarm even though the main is normal.	The AC input power is not connected well.	Check if input power cord firmly connected to the mains.
	The AC input is connected to the UPS output.	Plug AC input power cord to AC input correctly.
The icon  is flashing and the warning code <b>EP</b> is lighting on LCD display. Alarm is sounding every second.	EPO function is activated.	Set the circuit in closed position to disable EPO function.
The icon  is flashing and <b>S.F</b> is lighting on LCD display. Alarm is sounding every second.	Line and neutral conductors of UPS input are reversed.	Rotate mains power socket by 180° and then connect to UPS system.
The icon  and  are flashing and the warning code is show as <b>BC</b> on LCD display. Alarm is sounding every second.	The external or internal battery is incorrectly connected.	Check if all batteries are connected well.
Fault code is shown as 27 and the icon  is lighting on LCD display and alarm is continuously sounding.	Battery voltage is too high or the charger is fault.	Contact your dealer.
Fault code is shown as 28 and the icon  is lighting on LCD display and alarm is continuously sounding.	Battery voltage is too low or the charger is fault.	Contact your dealer.
The icons of  and <b>OVERLOAD</b> are flashing and the warning code is show as <b>OL</b> on LCD display. Alarm is sounding twice every second.	UPS is overloaded	Remove excess loads from UPS output.
	UPS is overloaded. Devices connected to the UPS are fed directly by the electrical network via the Bypass.	Remove excess loads from UPS output.
	After repetitive overloads, the UPS is locked in the Bypass mode. Connected devices are fed directly by the mains.	Remove excess loads from UPS output first. Then shut down the UPS and restart it.



Symptom	Possible cause	Remedy
Fault code is shown as 43 and The icon <b>OVERLOAD</b> is lighting on LCD display and alarm is continuously sounding.	The UPS shut down automatically because of overload at the UPS output.	Remove excess loads from UPS output and restart it.
Fault code is shown as 14 and the icon <b>SHORT</b> is lighting on LCD display. Alarm is continuously sounding.	The UPS shut down automatically because short circuit occurs on the UPS output.	Check output wiring and if connected devices are in short circuit status.
Fault code is shown as 01, 02, 03, 04, 11, 12, 13 and 41 on LCD display and alarm is continuously sounding.	A UPS internal fault has occurred. There are two possible results: 1. The load is still supplied, but directly from AC power via bypass. 2. The load is no longer supplied by power.	Contact your dealer
Battery backup time is shorter than nominal value	Batteries are not fully charged	Charge the batteries for at least 5 hours and then check capacity. If the problem still persists, consult your dealer.
	Battery has expired	Contact your dealer to replace the battery.
Fault code is shown as 05 on LCD display. At the same time, alarm is continuously sounding and output is cut off.	A UPS internal fault has occurred and BUS is short circuited.	Consult your dealer. If the UPS power is on again before repair, the DC/DC mosfet will damage.

## 5. Storage and Maintenance

### Operation

The UPS system contains no user-serviceable parts. If the battery service life (3~5 years at 25°C ambient temperature) has been exceeded, the batteries must be replaced. In this case, please contact your dealer.

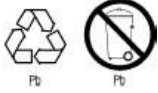

Be sure to return expired batteries to a recycling facility.

### Storage

Before storing, charge the UPS 5 hours. Store the UPS covered and upright in a cool, dry location. During storage, recharge the battery in accordance with the following table:

Storage Temperature	Recharge Frequency	Charging Duration
-25°C - 40°C	Every 3 months	1-2 hours
40°C - 45°C	Every 2 months	1-2 hours

## 6. Specifications

MODEL		DTK-UPS1000R(E)	DTK-UPS1500R(E)	DTK-UPS2000R(E)	DTKUPS3000R(E)
Capacity	VA	1000 VA	1500 VA	2000 VA	3000 VA
	W	900 W	1350 W	1800 W	2700 W
<b>INPUT</b>					
Voltage Range and Req. Power	Rated Voltage	100*/110*/115*/120/127 VAC			
	Required Power	15A	15A	20A	30A
	Low Line Transfer	80 VAC/70 VAC/60 VAC/55 VAC ± 5 % (based on load percentage 100%-80% / 80%-70% / 70%-60% / 60%-0)			
	Low Line Comeback	85 VAC/75 VAC/65 VAC/60 VAC ± 5 %			
	High Line Transfer	150 VAC ± 5 %			
	High Line Comeback	140 VAC ± 5 %			
Frequency Range		50Hz/ 60Hz			
Power Factor		≥ 0.99 @normal voltage			
<b>OUTPUT</b>					
Output Voltage		100*/110*/115*/120/127VAC			
AC Voltage Regulation		± 1%			
Frequency Range		47 ~ 53 Hz or 57 ~ 63 Hz (Synchronized Range)			
Frequency Range		50Hz ± 0.5% or 60Hz ± 0.5% (Bat. Mode)			
Current Crest Ratio (CF)		3:1 (max.)			
Harmonic Distortion (THDU)		≤ 2% (Linear load); ≤ 4% (Non-Linear load)			
Transfer Time	AC to DC	Zero			
	Inverter to Bypass	4 ms (Typical)			
Waveform (Batt. Mode)		Pure Sine wave			
<b>EFFICIENCY</b>					
AC Mode		90%	90%	91%	91%
Battery Mode		88%	89%	88%	90%
<b>BATTERY</b>					
Battery Type		12V/9Ah	12V/9Ah	12V/9Ah	12V/9Ah
Numbers		2	3	4	6
Typical Recharge Time		4 hours recover to 90% capacity			
Charging Current (max.)		1.5A Max (Up to 8A with External Battery Pack)			
Charging Voltage		27.4 VDC ± 1%		54.8 VDC ± 1%	82.1VDC ± 1%
<b>INDICATORS</b>					
LCD		UPS status, Load level, Battery level, Input/Output/battery info, Discharge time and Fault indicators			
<b>ALARM</b>					
Battery Mode		Sounding every 4 seconds			
Low Battery		Sounding every second			
Overload		Sounding twice every second			
Fault		Continuously sounding			
<b>PHYSICAL</b>					
Dimension, DxWxH (in)		16.14 x 17.24 x 3.46	16.14 x 17.24 x 3.46	20.10 x 17.24 x 3.46	24.80 x 17.24 x 3.46
Net Weight (lbs)		29.10	31.97	47.18	65.26
<b>ENVIRONMENT</b>					
Humidity		20-90 % RH @ 0- 40°C (non-condensing)			
Noise Level		Less than 50dBA @ 1 Meter			
<b>MANAGEMENT</b>					
Smart RS-232/USB		Supports Windows 2000/2003/XP/Vista/2008/7/10, Linux, Unix, and MAC			
Optional SNMP		Power management from SNMP manager and web browser. Included with models ending in E.			

\*Derate capacity to 95% when the output voltage is adjusted to 115VAC, derate capacity to 90% when the output voltage is adjusted to 110VAC and derate capacity to 80% when the output voltage is adjusted to 100VAC.

## External Battery Pack Specification

<b>Model</b>	<b>DTK-UXB1000R</b>	<b>DTK-UXB1500R</b>	<b>DTK-UXB2000R</b>	<b>DTK-UXB3000R</b>
Used with UPS Models	DTK-UPS1000R(E)	DTK-UPS1500R(E)	DTK-UPS2000R(E)	DTK-UPS3000R(E)
Battery Type	12V 9Ah	12V 9Ah	12V 9Ah	12V 9Ah
Battery Numbers	4	6	8	12
Dimensions(in)	16.14 x 17.24 x 3.46	16.14 x 17.24 x 3.46	20.10 x 17.24 x 3.46	24.80 x 17.24 x 3.46
Net Weight(lbs)	37.70	47.40	63.93	90.83

**CAUTION:** Battery pack can only be used with corresponded UPS.

## 7. Warranty

DITEK (Diversified Technology Group, Inc.) warrants equipment manufactured by it to be free from defects in materials and workmanship for three (3) years from the date of invoice from DITEK or its authorized sales channels. DITEK assumes no risk or liability for results of the use of the products purchased from it, including but without limiting the generality of the foregoing: (1) The use in combination with any electrical or electronic components, circuits, systems, assemblies or any other materials or substances; (2) Unsuitability of any product for use in any circuit or assembly. This limited warranty does not apply if the DITEK product has been misused, abused, altered, tampered with, or used in applications other than specified on the name plate or not used and/or installed consistent with the installation instructions provided with the product and periodically updated on the DITEK web site, [www.diteksurgeprotection.com](http://www.diteksurgeprotection.com). This limited warranty does not apply if the cause of the failure to properly perform is fire, flood, windstorm, earthquake, direct lightning, or sustained over-voltage or open-neutral events.

Purchaser's rights under the limited warranty shall consist solely of requiring DITEK to repair, or at DITEK's sole discretion, replace, free of charge, F.O.B. factory, any defective items received at said factory within said three years and determined by DITEK to be defective. Providing or not providing any advice or recommendations by DITEK shall not constitute any additional or other warranty by, or impose any liability upon, DITEK.

**EXCLUSIVE AND LIMITED WARRANTY:** DITEK's standard limited warranty is the only warranty applicable to the sale of DITEK's product. DITEK's limited warranty may be modified only by a writing signed by a duly authorized officer of DITEK; Purchaser assumes all other responsibility for in combination with other goods whether supplied by DITEK or otherwise. Purchaser acknowledges that any technical advice furnished by DITEK with respect to the use of the products is given without charge and DITEK assumes no obligation or liability to Purchaser for the advice given or results obtained, all such advice is given by DITEK and accepted by Purchaser at Purchaser's risk.

**DITEK'S LIMITED WARRANTY IS IN LIEU OF AND EXCLUDES ALL OTHER WARRANTIES; EXPRESS OR IMPLIED, INCLUDING, WITHOUT LIMITATION, MERCHANTABILITY AND FITNESS FOR A PARTICULAR PURPOSE WHETHER OR NOT THE PURPOSE OF USE OF THE GOODS HAS BEEN DISCLOSED TO SELLER IN SPECIFICATIONS, DRAWINGS, OR OTHERWISE AND WHETHER OR NOT THE GOODS ARE SPECIFICALLY DESIGNED AND/OR MANUFACTURED BY SELLER FOR BUYER'S USE OR PURPOSE.**

**LIMITATION OF LIABILITY, AND OF CONSEQUENTIAL AND OTHER DAMAGES:** IN NO EVENT SHALL DITEK ASSUME ANY LIABILITY FOR (A) DAMAGES IN EXCESS OF THE PURCHASE PRICE PAID FOR THE PRODUCTS OR (B) INDIRECT, SPECIAL, INCIDENTAL, PUNITIVE, OR ECONOMIC CONSEQUENTIAL DAMAGES OF ANY KIND WHATSOEVER INCLUDING WITHOUT LIMITATION, LOSS OF USE, DATA, PROFIT, OR REVENUE, OR LOSS OR DAMAGE TO PROPERTY OR EQUIPMENT, OR OTHER ECONOMIC LOSS INCURRED BY BUYER, WHETHER ANY CLAIM IS BASED UPON THEORIES OF INFRINGEMENT, WARRANTY, CONTRACT, NEGLIGENCE, STRICT LIABILITY, TORT OR OTHERWISE, EVEN IF SELLER HAS BEEN APPRISED OF THE POSSIBILITY OF SUCH DAMAGES.

The product covered by this limited warranty certificate can only be repaired or replaced by the factory. A RETURN MATERIAL AUTHORIZATION NUMBER (RMA) must be obtained by calling Customer Service at 800-753-2345. DITEK shall not be responsible for any transportation charges. Returned freight must be pre-paid.

## 8. Regulatory Compliance

### **FCC Notice, Class A**

This equipment has been tested and found to comply with the limits for a Class A digital device, pursuant to part 15 of the FCC Rules. These limits are designed to provide reasonable protection against harmful interference when the equipment is operated in a commercial environment. This equipment generates, uses, and can radiate radio frequency energy and, if not installed and used in accordance with the instruction manual, may cause harmful interference to radio communications. Operation of this equipment in a residential area is likely to cause harmful interference in which case the user will be required to correct the interference at his own expense.

**WARNING:** Changes or modifications not expressly approved by the party responsible for compliance could void the user's authority to operate the equipment.



