

PHOTOELECTRIC DETECTOR

AX-100PLUS, AX-200PLUS, AX-100ALPHA, AX-200ALPHA

Please read instructions completely before beginning installation.

Photoelectric detectors detect intruders when both the upper and lower invisible infrared beams are simultaneously broken. Maximum detection range between Transmitter and Receiver is 100ft. (30m) for AX-100PLUS / 100ALPHA and 200ft. (60m) for AX-200PLUS / 200ALPHA.

FEATURES

1. LED indicator for fine beam alignment level : Accurate and reliable alignment is easily achieved by using LED indicators located on the Receiver.
 AX-100/200PLUS : Alarm indicator is located on the front of the inner housing and in the view finder.
 AX-100/200ALPHA : Course Alignment LED and Alarm indicator are on the front of the inner housing and only Course Alignment LED is in the view finder.
2. Fine angle adjustment for alignment : With just a turn of the dials, optical alignment is adjusted vertically and horizontally.
3. Selectable beam frequencies : Crosstalk is eliminated with 4 channel selectable, beam frequencies. Used when stacking beams or for long range applications. (for AX-100/200ALPHA)
4. Form C relay : Form C relay for more applications.
5. Anti-Frost structure with visor : Visor structure prevents fog and condensation from blocking the beams.
6. Beam interruption time adjustment : This function allows you to select the suitable beam interruption time for any environment.
7. Alignment level monitor jack
8. Optional Accessories : Heating unit(HU-2), Back cover (BC-2)
9. UL Listed

1. PARTS IDENTIFICATION

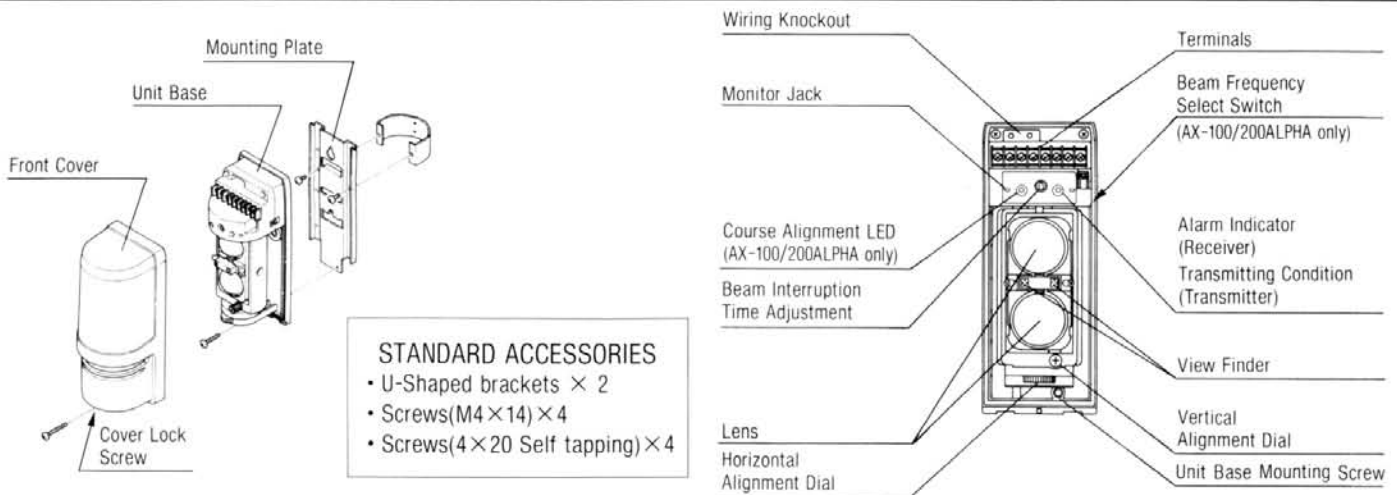

2. INSTALLATION HINTS

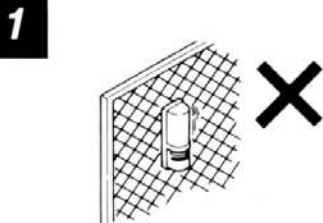

Mount unit only on a solid surface.

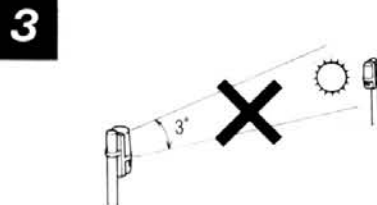

Prevent direct sunlight from entering into internal optics.

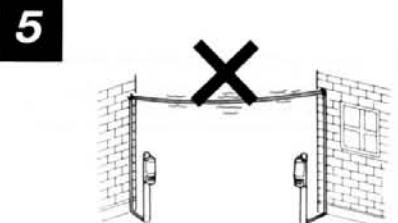

Avoid aerial wiring.

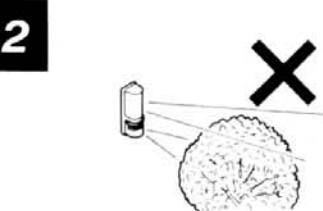

Do not install the unit where falling leaves or seasonal growth of branches will block the beam.

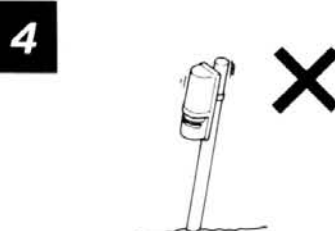

The mounting pole should have a solid footing with little movement at the top of the pole.

- 6**
- For indoor applications wiring is similar to the installation of a telephone or intercom.
 - For outdoor wiring, apply wire conduit as far as possible. Some sites will require shielded cables or underground wiring work.

3. INSTALLATION METHOD

a. General

1 Detection range and installation height

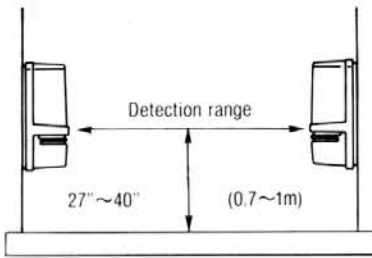

Maximum distances between Receiver and Transmitter are listed below.

AX-100PLUS/AX-100ALPHA = 100ft(30m)Max
 AX-200PLUS/AX-200ALPHA = 200ft(60m)Max
 and the installation height should be at 27"~40". (0.7~1m)

2 Alignment angle

Horizontally

Vertically

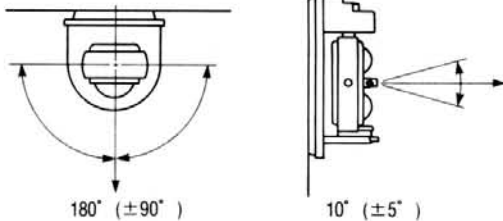

3 Pole mounting

* Pole size should be as follows : 1 11/16"~1 7/8" (φ43~48 mm) (Standard U.S. 1 1/4" or 1 1/2" pipe)

* The length of the wiring cable out of the pole should be within 20 inches(60cm).

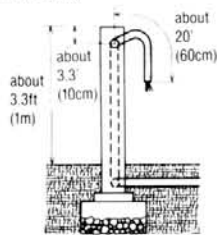

* Face transmitter and receiver towards each other when pole mounting.

b. Installation Method

1



Cover Lock Screw

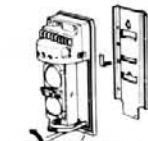

Unit Base Mounting Screw

Loosen the cover lock screw and remove the front cover. And loosen the unit base mounting screw and remove mounting plate by sliding it down against the unit base.

2

Wall mounting

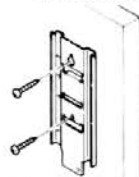

Pull out the wire through the wiring hole on the mounting plate and attach the plate to the wall with the screw.

Pole mounting



Place U-shape brackets at the top of the pole. And pull out the wire through the wiring hole of the mounting plate, attach the mounting plate to the U-Shape bracket with screw.

Two unit installation (back to back)

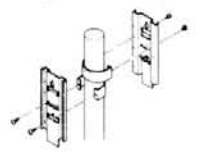

Fix two U-shape brackets in layers on a pole, two units can be installed back to back on a pole at the same height.

3

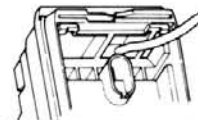

Pull the wire through the wiring hole of the unit base, then hook the top of the unit base on the mounting plate and push on the bottom of the base until it is seated against mounting plate, then install mounting screw.

4

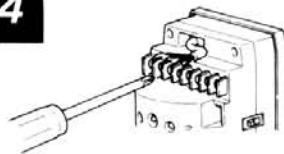

* Connect wire to the terminals. (See Sec.4 Terminal And Wiring)

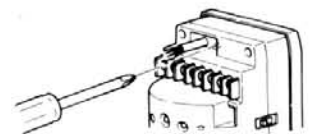

* Make a hole in the rubber bushing at the mark on the right hand side (●), if a second wire is used.

5



After checking optical alignment and operation check (See Sec.5 OPTICAL ALIGNMENT), replace the cover, and fasten the cover lock screw tightly.

4. TERMINAL AND WIRING

Receiver

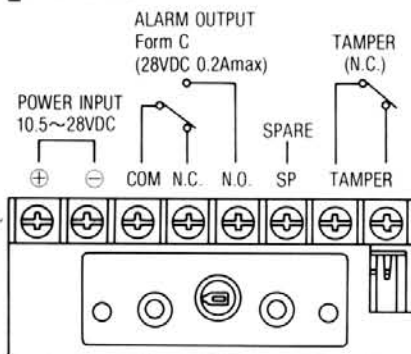

Transmitter

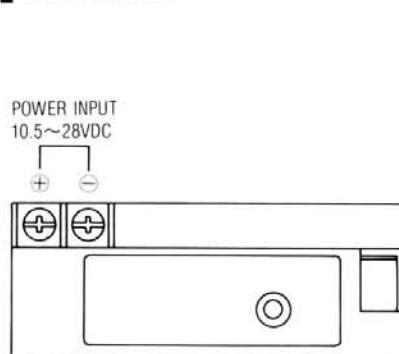

Wiring Distance

- When using two or more units on one wire, the maximum length is obtained by dividing the maximum wire length listed below by the number of units (one unit is = to either one transmitter or one receiver) used.
- Power wires should not exceed the following lengths :

WIRE SIZE	12VDC	24VDC
AWG22(0.33mm ²)	1600'(500m)	8100'(2500m)
AWG20(0.52mm ²)	2600'(800m)	13000'(4000m)
AWG18(0.83mm ²)	4000'(1200m)	19500'(6000m)
AWG16(1.31mm ²)	6500'(2000m)	32500'(10000m)

UL requires AX-100/200PLUS & AX-100/200ALPHA to be connected to a UL listed power supply capable of providing a nominal input of 12VDC,(10.5~28VDC) 46mA and battery standby time of 4 hours.

5.OPTICAL ALIGNMENT

The reliability of PHOTOELECTRIC DETECTOR depends on the optical alignment level. Using the following method, be sure to obtain the maximum voltage from the monitor jack using a volt-meter.

Step1

Beam Frequencies Selection

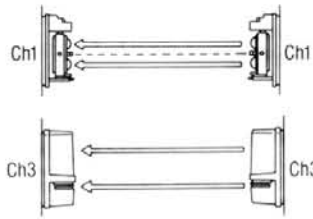

See Sec.6 Selectable Beam Frequencies

Select the beam frequencies switch.
(AX-100/200ALPHA only)

Step2

Horizontal & Vertical Adjustment

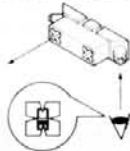

Looking into view finder of the Transmitter, and adjust the lens horizontally and vertically, so that the Receiver can be seen in the center of the sight.

① HORIZONTAL ADJUSTMENT

Course adjustment

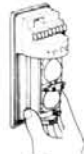

Aim lens of Transmitter and Receiver at each other by gripping the lens bracket and turning left or right.

Fine horizontal adjustment



Looking into view finder, turn horizontal alignment dial to make adjustment.

② VERTICAL ADJUSTMENT

Fine vertical adjustment

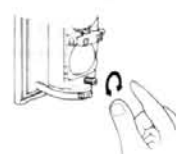

Looking into view finder, turn vertical alignment dial with fingers or screw driver.

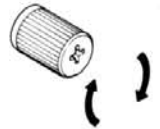

Turning vertical alignment right moves the Lens upward, and left downward.

Step3

AX-100PLUS
AX-200PLUS

Checking by Alarm Indicator LED

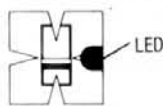

Please don't forget to obtain the maximum voltage from the monitor jack, using a voltage meter, to achieve the most stable beam. (Step 4)

LED AT THE FRONT BODY	LED INSIDE THE VIEW FINDER	ALARM INDICATOR LED STATUS
		LED ON : Beam energy is not reaching from Transmitter to Receiver. LED OFF : The Transmitter's beam energy is reaching the Receiver.
* Before going to Step 4, confirm that LED is OFF.		

AX-100ALPHA
AX-200ALPHA

Checking by Course Alignment LED

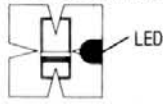

Look into the view finder of the Receiver and make fine adjustments horizontally and vertically. At this time, the Transmitter should be kept in center of the sight and the Course Alignment LED should be turned off.

By checking Course Alignment LED at the front body or inside the view finder, a course alignment is achieved. Please don't forget to obtain the maximum voltage from the monitor jack, using a voltage meter, to achieve the most stable beam. (Step 4)

LED AT THE FRONT BODY	LED INSIDE THE VIEW FINDER	INDICATOR LED STATUS						
		<p>Alarm Indicator LED ON : Beam energy is not reaching from Transmitter to Receiver. LED OFF : The Transmitter's beam energy is reaching the Receiver.</p> <p>Course Alignment LED Alignment Level : <table border="1"> <tr> <td>No Alignment</td> <td>Poor</td> <td>Realign</td> </tr> <tr> <td>ON</td> <td>ON & OFF</td> <td>OFF</td> </tr> </table> LED indicator : (See Alignment Level Chart in Step 4.)</p>	No Alignment	Poor	Realign	ON	ON & OFF	OFF
No Alignment	Poor	Realign						
ON	ON & OFF	OFF						
* : Step 4 must be completed in order to achieve a stable beam alignment. * Before going to Step 4, confirm that LED is OFF.								

Step4

Checking From The Monitor Jack

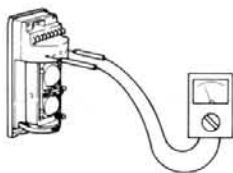

Connect the volt-meter to Receiver's (+) and (-) monitor jack and make fine optical adjustment.

After the adjustments are made by observing the LED indicators, check the voltage from the monitor jack using a voltage meter to obtain the most stable beam.

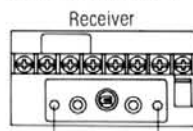

Insert a volt-meter's probes into the Monitor-Jacks located on the front body of the receiver. If an Analog Volt-Meter is used, observe polarity.

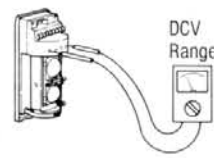

Set the volt-meter range to 5 ~10 VDC.

The alignment level of the beams can be confirmed by comparing the voltage readings to the following chart. Be sure to obtain greater than an excellent monitor jack output, 2.5V

ALIGNMENT LEVEL	Poor	Realign	Fair	Good	Excellent
MONITOR JACK OUTPUT	0v	> 1v	> 1.5v	> 2v	> 2.5v

Optical Alignment for Indoor Use

Obtain maximum voltage from the monitor jack, at least more than 1.3V

Confirmation of Action

- Check that the alarm indicator light is OFF.
- If the alarm indicator light is ON even though the beams are not blocked, re-adjust the optical alignment and check wiring (See Sec.5)
- After alignment is achieved and unit works properly, conduct a walk test from at least at following three points.
 - In front of the Transmitter
 - In front of the Receiver
 - At the middle point between Receiver and Transmitter

6. SELECTABLE BEAM FREQUENCIES

(AX-100 / 200ALPHA only)

BEAM FREQUENCY
SELECT SWITCH

1 2 3 4



The selectable beam frequencies can be used to avoid unwanted crosstalk that can occur when using multiple photobeams for long distance or beam stacking applications.

- To select between 4 separate beam frequencies, use the switch provided.
- Make sure the receiver and transmitter that are facing each other are set to the same code.

IMPORTANT Always switch the frequencies TWO channels apart when stacking units on top of one another (See following example). The upper unit is set on channel 1 while the lower is on channel 3, channels 2 and 4 could have also been used.

1 2 beam stacking

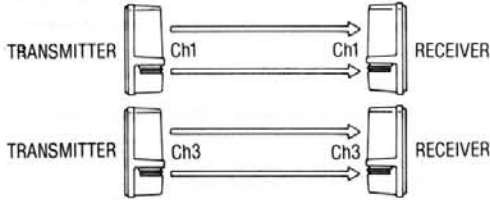

3 2 beam long distance stacking

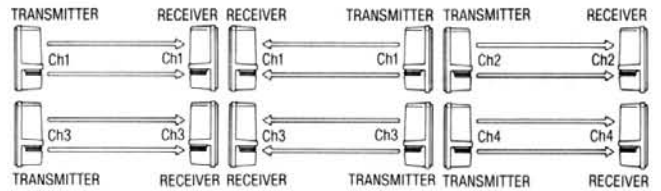

2 Long distance

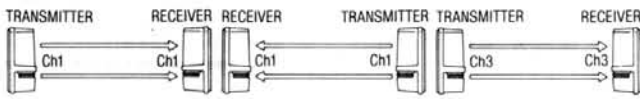

4 Perimeter protection

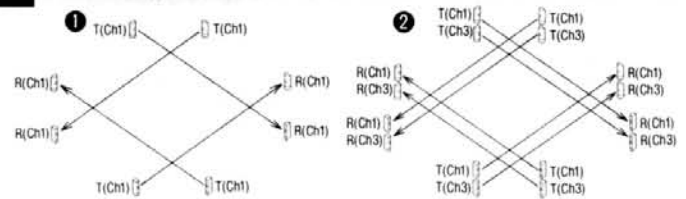

7. BEAM INTERRUPTION TIME ADJUSTMENT

The beam interruption time adjustment is on Receiver unit. This function allows you to match the units sensitivity to its surroundings. Slower settings reduce sensitivity.

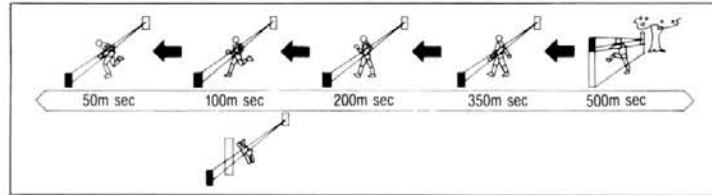
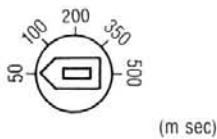

CAUTION :

- Speeds shown above are the maximum detectable speeds for each setting. Faster speeds will not be detected. Where birds, newspapers or flying debris can occasionally interrupt the beams, adjust setting to a slower speed (longer interruption period.)
- Beam interruption times exceeding 70 msec do not comply with the requirements in UL639, Intrusion Detection Units.

8. SPECIFICATIONS

Model	AX-100PLUS	AX-200PLUS	AX-100ALPHA	AX-200ALPHA	
Detection Method	Infrared Photoelectric				
Range	Outdoor	100ft(30m)	200ft(60m)	100ft(30m)	200ft(60m)
	Indoor	200ft(60m)	400ft(120m)	200ft(60m)	400ft(120m)
Maximum Arrival Distance	1000ft (300m)	2000ft (600m)	1000ft (300m)	2000ft (600m)	
Beam Characteristics	Pulsed Infrared				
Selectable Beam Frequency				4 channel (Automatic Synchronization)	
Interruption Period	50~500msec(Selectable)				
Power Input	10.5~28VDC				
Current Draw (transmitter + receiver)	Normal operation		Normal operation		
	46mA max		40mA		
			During optical alignment		
			46mA max		
Alarm Period	2sec(±1) nominal				
Alarm Output	Form C Relay (28VDC 0.2A max)				
Tamper Switch	N.C. opens when cover is removed (RECEIVER only)				
Operating Temperature	-13° F~131° F(-25° C~+55° C)		-30° F~131° F(-35° C~+55° C)		
Environment Humidity	95%max				
Alignment Angle	±5° Vertical, ±90° Horizontal				
Mounting	Wall or Pole				
Weight	36.7oz(1040g) (both Transmitter and Receiver)				

Specifications and design are subject to change without prior notice.

9. DIMENSIONS

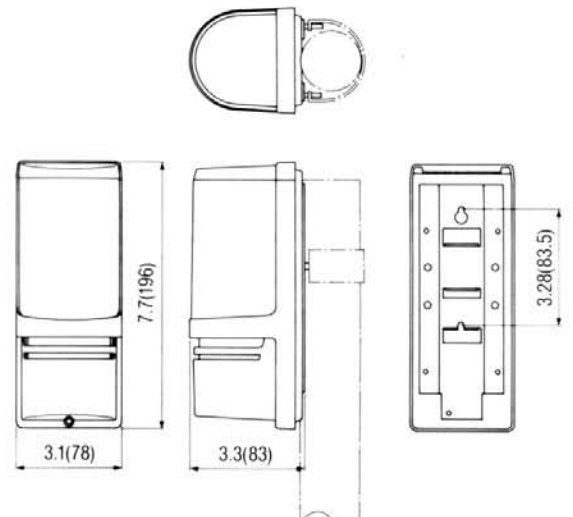

inches(mm)

10. TROUBLE SHOOTING CHECK SHEET

1. "No Action" on the transmitter or receiver after power has been applied.

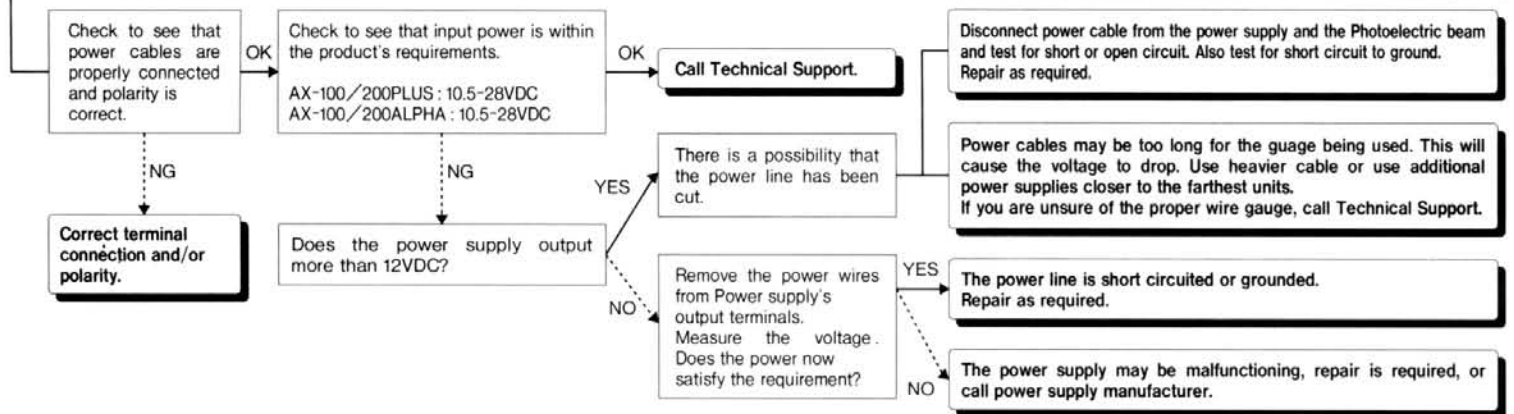

2. "No Action" on alarm zone even though the beams are completely blocked.

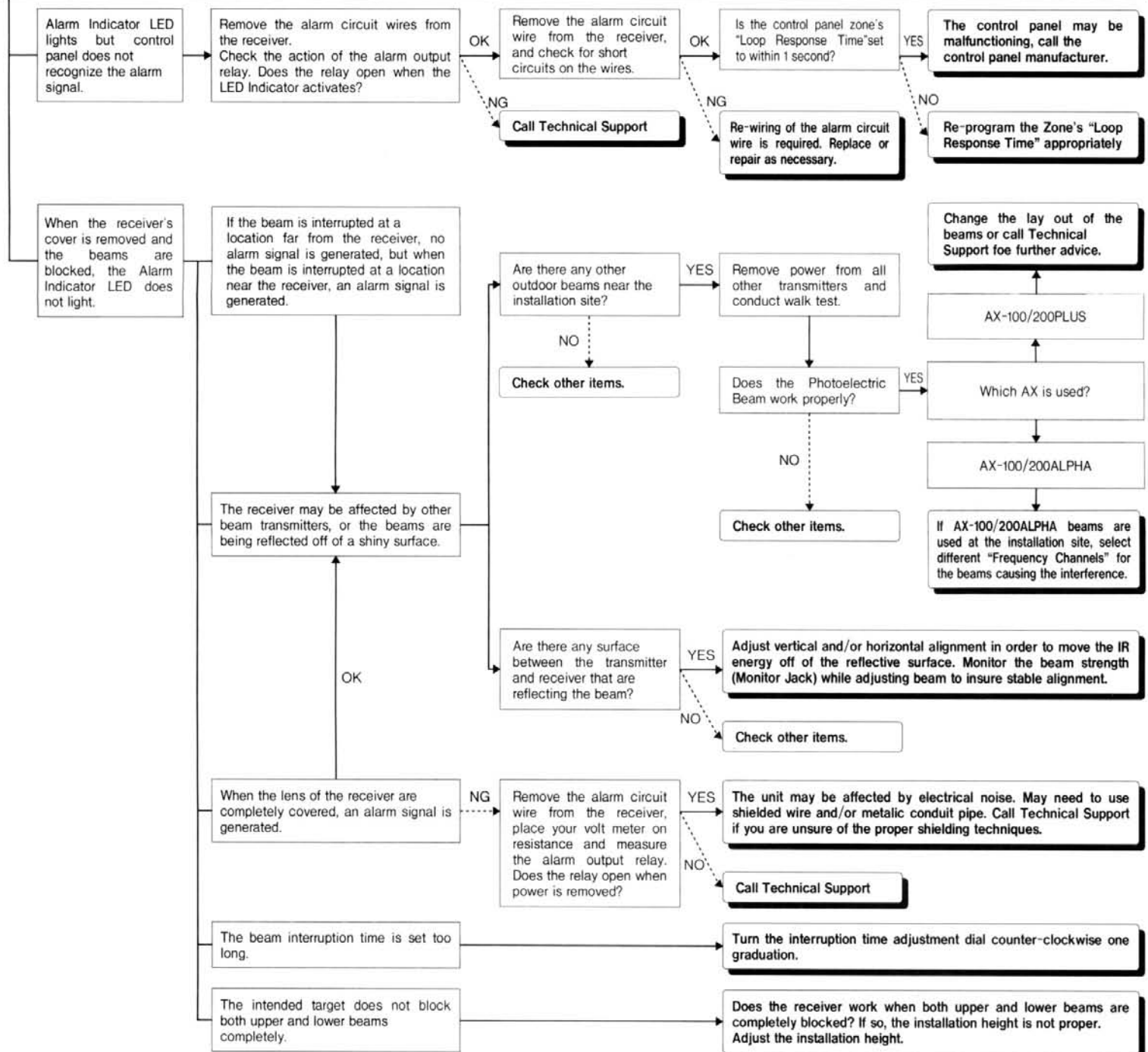

3. Alarm signal is being generated though beams are not blocked

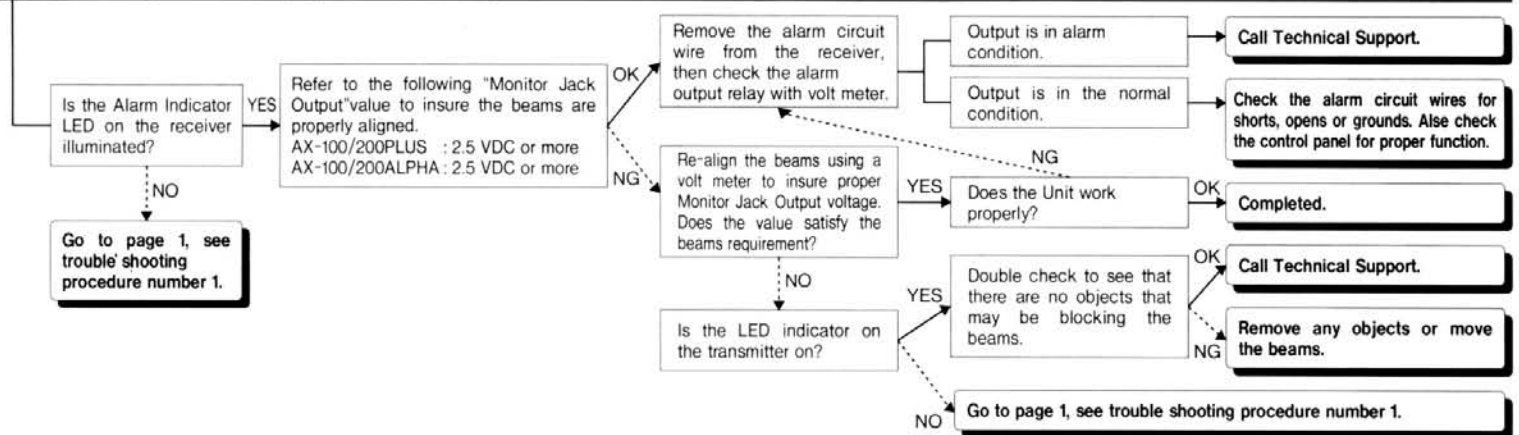

4. False activations

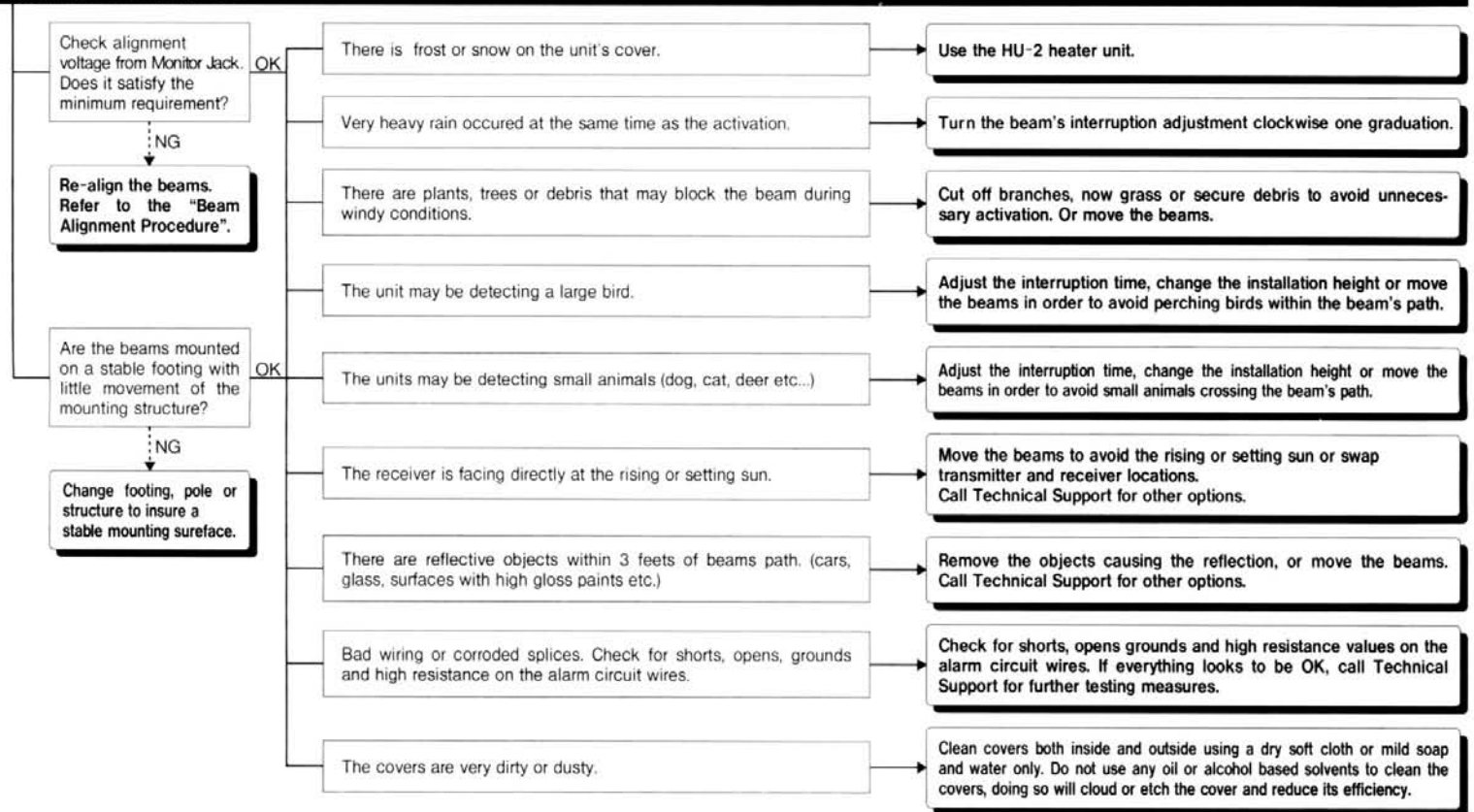

Important

The majority of false activations can be attributed to poor beam alignment. When aligning outdoor beams accept no less than an "EXCEL" value for the most stable and trouble free system!! Refer to the installation manual for acceptable Monitor Jack Voltage Values.

NOTE

This unit is designed to detect an intruder and activate an alarm control panel. Being only a part of a complete system, we cannot accept responsibility for any damages or other consequences resulting from an intrusion.



OPTEX CO., LTD. (ISO 9001 Certified by LRQA)
4-7-5 Nionohama Otsu, 520-0801 Japan
TEL (077)524-6047 FAX (077)522-9022

OPTEX AMERICA, INC.
1845W 205th St. Torrance, CA 90501-1510 U.S.A.
TEL(310)533-1500 FAX(310)533-5910

OPTEX (EUROPE) LTD. (ISO 9002 Certified by NQA)
Clivemont Road Cordwallis Park Maidenhead Berkshire SL6 7BU U.K.
TEL(01628)631000 FAX(01628)636311