

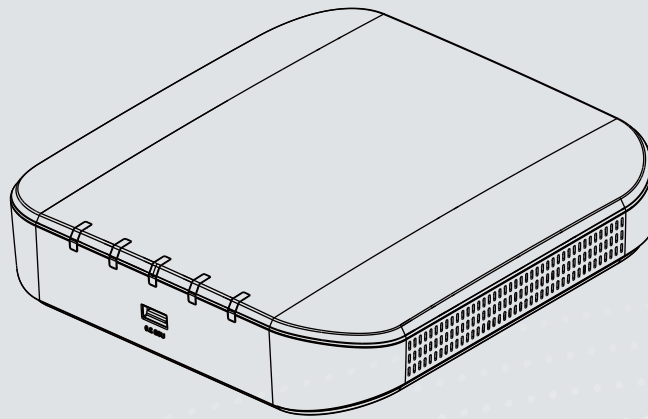

RX9401 H.265 Video Receiver

User's Manual

H.265/H.264 • 16 CH • HDMI • ONVIF



Rev. 1.1

Table of Contents

Chapter One Hardware Installation and Initial Configuration	5
Introducing the Network Video Recorder	5
Special Features	6
Safety	6
Chassis Dimensions	7
Physical Description	8
Topology	9
Hardware Installation	10
Interface Connections	11
Initial Configuration - via a Local Console	12
Initial Configuration - via a Web Console (Optional)	15
LED Indicators	17
Power Up and Power Down	18
Section One Management over a Local Console	19
Chapter Two Introduction to the Local Console Interface	19
2-1. How to Begin	21
2-2. Operation on a Camera View Cell	25
2-2-1. PTZ Panel	25
2-2-2. Digital Zoom Panel	29
2-2-3. Others	30
2-2-4. Right-click Commands	31
Chapter Three Configuration Using the Local Console	32
The Main Control Portal	32
3-1. Layout	32
3-2. Settings	33
3-2-1. Settings - Overview	33
3-2-2. Settings - Camera - Management	34
3-3-1. Settings - System - Information	39
3-3-2. Settings - System - Maintenance	40
3-3-3. Settings - System - Display	41
3-4. Settings - User	42
3-5. Settings - Network	43
Settings - Network - IP	43
Settings - Service	44
3-6. Information	45
Section Two Management over a Web Console	46
Technical Specifications	49
Safety and Compatibility	51

Revision History

- * Rev. 1.0: Initial release.
- * Rev. 1.1: Corrected the video feed from camera that is used for streaming.

Technology License Notice



Notices from HEVC Advance:

THIS PRODUCT IS SOLD WITH A LIMITED LICENSE AND IS AUTHORIZED TO BE USED ONLY IN CONNECTION WITH HEVC CONTENT THAT MEETS EACH OF THE THREE FOLLOWING QUALIFICATIONS: (1) HEVC CONTENT ONLY FOR PERSONAL USE; (2) HEVC CONTENT THAT IS NOT OFFERED FOR SALE; AND (3) HEVC CONTENT THAT IS CREATED BY THE OWNER OF THE PRODUCT. THIS PRODUCT MAY NOT BE USED IN CONNECTION WITH HEVC ENCODED CONTENT CREATED BY A THIRD PARTY, WHICH THE USER HAS ORDERED OR PURCHASED FROM A THIRD PARTY, UNLESS THE USER IS SEPARATELY GRANTED RIGHTS TO USE THE PRODUCT WITH SUCH CONTENT BY A LICENSED SELLER OF THE CONTENT. YOUR USE OF THIS PRODUCT IN CONNECTION WITH HEVC ENCODED CONTENT IS DEEMED ACCEPTANCE OF THE LIMITED AUTHORITY TO USE AS NOTED ABOVE.

H.264

THIS PRODUCT IS LICENSED UNDER THE AVC PATENT PORTFOLIO LICENSE FOR THE PERSONAL AND NON-COMMERCIAL USE OF A CONSUMER TO (i) ENCODE VIDEO IN COMPLIANCE WITH THE AVC STANDARD ("AVC VIDEO") AND/OR (ii) DECODE AVC VIDEO THAT WAS ENCODED BY A CONSUMER ENGAGED IN A PERSONAL AND NON-COMMERCIAL ACTIVITY AND/OR WAS OBTAINED FROM A VIDEO PROVIDER LICENSED TO PROVIDE AVC VIDEO. NO LICENSE IS GRANTED OR SHALL BE IMPLIED FOR ANY OTHER USE. ADDITIONAL INFORMATION MAY BE OBTAINED FROM MPEG LA, L.L.C. SEE [HTTP://WWW.MPEGLA.COM](http://www.mpegla.com)



Read Before Use

The use of surveillance devices may be prohibited by law in your country. The Network Video Receiver is not only a high-performance web-ready camera but can also be part of a flexible surveillance system. It is the user's responsibility to ensure that the operation of such devices is legal before installing this unit for its intended use.

It is important to first verify that all contents received are complete according to the Package Contents listed below. Take note of the warnings in the Quick Installation Guide before the Network Video Receiver is installed; then carefully read and follow the instructions in the Installation chapter to avoid damage due to faulty assembly and installation. This also ensures the product is used properly as intended.

The Network Video Receiver is a network device and its use should be straightforward for those who have basic networking knowledge. It is designed for various applications including video sharing, video recording, general security/surveillance, etc. The Configuration chapter suggests ways to best utilize the Network Video Recorder and ensure proper operations. For creative and professional developers, the URL Commands of the Network Video Recorder section serves as a helpful reference to customizing existing homepages or integrating with the current web server.



NOTE:

The operating system and management software are installed on a flash memory mounted on the main board. Except for the plug-ins for the onscreen control, there is no need to install software.

Package Contents

<ul style="list-style-type: none"> ■ RX9401 ■ Power adapter 	<ul style="list-style-type: none"> ■ Mouse ■ Quick Installation Guide
---	---

Symbols and Statements in this Document



INFORMATION: provides important messages or advices that might help prevent inconvenient or problem situations.



NOTE: Notices provide guidance or advices that are related to the functional integrity of the machine.



Tips: Tips are useful information that helps enhance or facilitate an installation, function, or process.



WARNING! or IMPORTANT: These statements indicate situations that can be dangerous or hazardous to the machine or you.



Electrical Hazard: This statement appears when high voltage electrical hazards might occur to an operator.

Chapter One Hardware Installation and Initial Configuration

Introducing the Network Video Recorder

VIVOTEK's RX9401 is an H.265 Single-Channel Ultra-HD Video Receiver. Delivering high-quality and detailed images, it is equipped for up to 16-CH network cameras and a maximum network camera resolution of 8-Megapixels. The RX9401 can drive an HD monitor directly via HDMI, and supports decode options of 4K 30 fps, four H.265 1080p 120 fps, nine H.265 720p 270 fps, or sixteen H.265 D1 480 fps. The RX9401 offers a more cost-effective and PC alternative solution with no costly VMS client fee, no HDD noise and no failure issues. It is suitable for standalone viewers through local viewing. Secured and simplified IT management reduce the requirement for end user training, further reducing long-term costs.

Space-saving, Flexible Installation

Compact size with fanless design for any small scale video surveillance installation, the RX9401 is perfect for a single display application that requires space-saving solutions. For more flexible installation, it supports, wall or desktop mount options.

Various Split-window Layout & Fisheye Dewarp Support

The RX9401 provides various split modes for layout display (1x1, 2x2, 3x3, 1P+3, 2P+3, 1M+5, 1P+6, 3V, 1M+12, 4x4) and supports VIVOTEK's fisheye camera Fisheye Dewarp function, which provides multiple de-warping modes to ensure the correct angle of video view and detailed information for flexible usage.

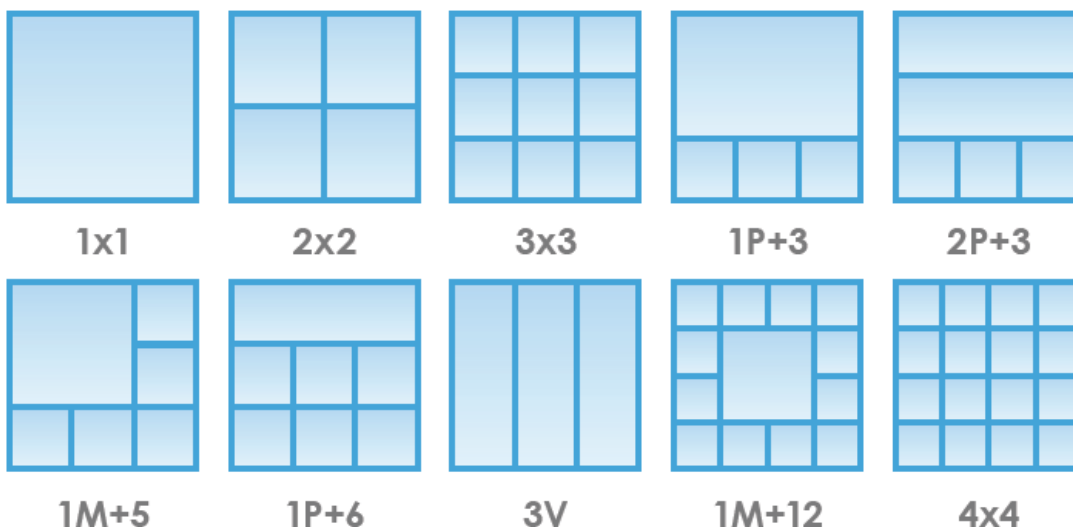

Special Features

● Runs on embedded Linux	● Fisheye Dewarp
● 1 x HDMI for local display up to 4K resolution	● Supports cameras of up to 8MP resolution
● Up to 16 Channel IP Camera Input	● ONVIF Compliance (Project Support Function)
● 1 x Gigabit RJ45 uplink Ethernet port;	● Supports Various Split-window Layout Display Modes
● 2 x USB 2.0 Port (1 in Front / 1 in Back)	● Snapshot / Export Media
● Size: 198 mm (W) x 200 mm (D) x 47 mm (H)	● PiP Video Control
● One Button Auto Setup	● Configuration Backup / Restore

- [Compatible with VIVOTEK VAST Central Management Software*](#)

Safety

- Connect the system to an earthed main power outlet.
- Never open the housing of the power supply unit.
- Install and operate the system only in a dry, weather-proof location.
- Observe the following safety factors:
 - Is there visible damage to the system or power cord?
 - Is the system operating correctly?
 - Has the system been exposed to rain or moisture?
 - Has the system been in a long storage under harsh conditions or exposed to unconfirming stress?
- The relevant electrical engineering regulations must be complied with at all times during the installation.
- Ensure that all maintenance and repair work is handled by qualified personnel such as electrical engineers or network specialists.
- Read this manual before installing or operating the system. The documentation contains important safety instructions about permitted uses.
- The rated AC input is: **100-240V~ 1.5A, 60-50Hz**; the max. consumption: **9.24W** (DC12V, 1.5A)
- If a fault occurs, disconnect the power cord from the power supply.
- Do not install the system close to heaters or other heat sources. Avoid locations with direct sunlight.
- All ventilation openings must not be blocked.
- Use only the cables shipped with system or use appropriate cables that can withstand electromagnetic interference.

Chassis Dimensions

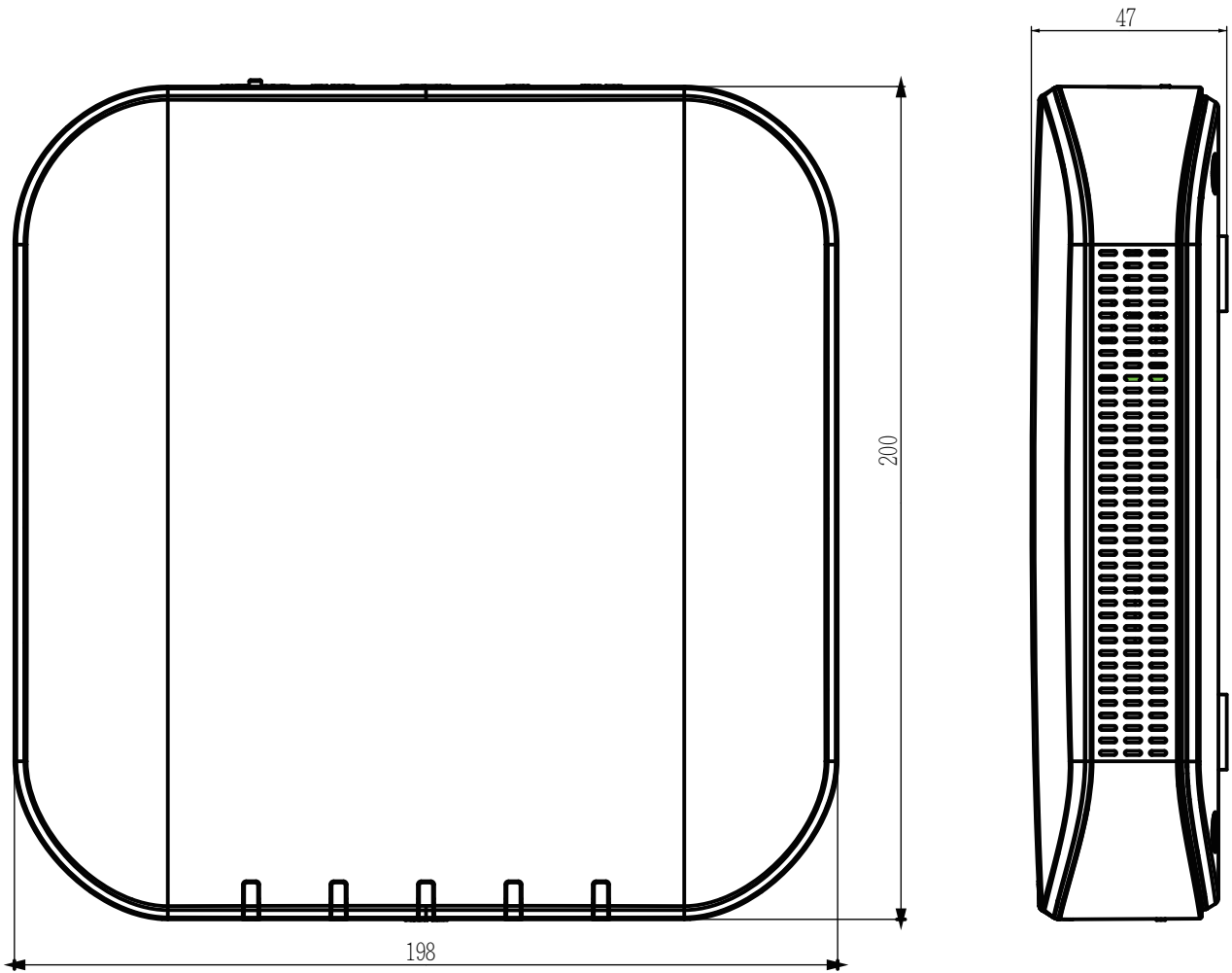

1 Physical Description

● Front View

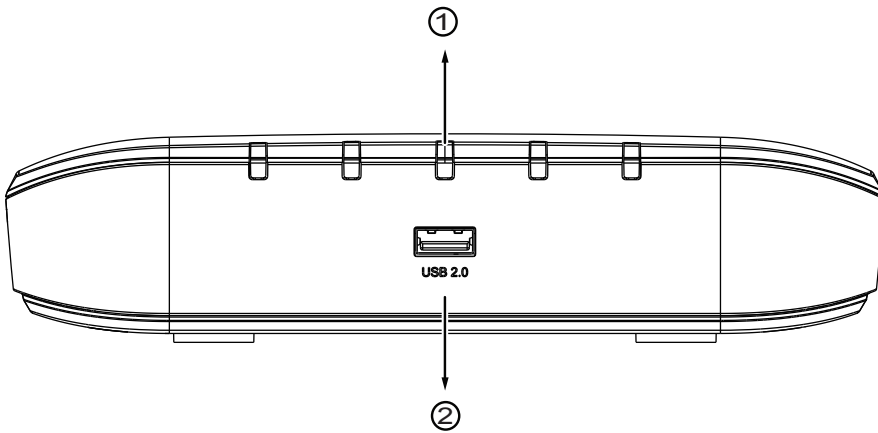

1	Activity LED: Please refer to page 17 for LED definitions.
2	USB 2.0 port

● Rear View

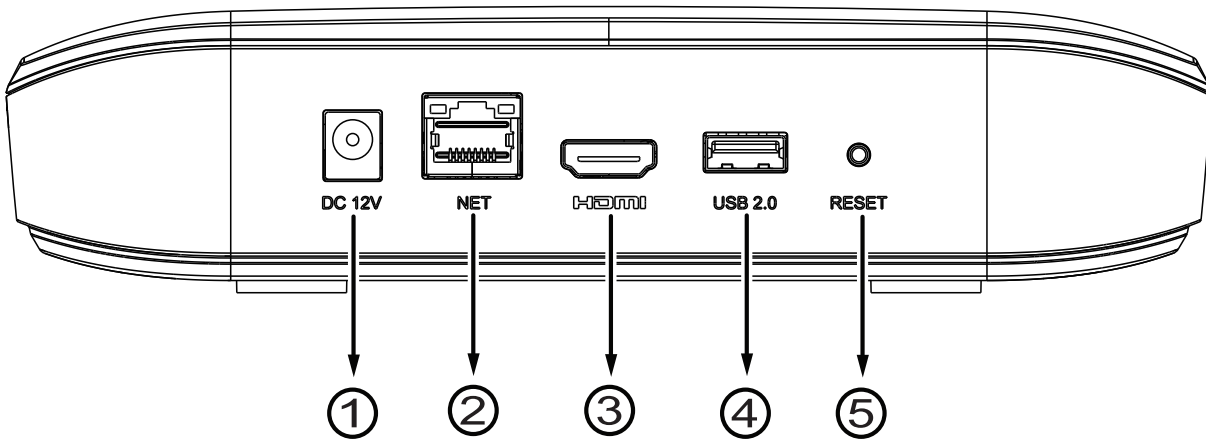

1	Power socket (DC12V, 1.5A)	4	USB port
2	10/100Mbps uplink port	5	Reset button
3	HDMI		

⚠ IMPORTANT:

It is important to leave a clearance of 10cm around the chassis. The clearance is required to ensure an adequate airflow through the chassis to ventilate heat.

To ensure normal operation, maintain ambient airflow. Do not block the airflow around chassis such as placing the system in a closed cabinet.

2 Topology

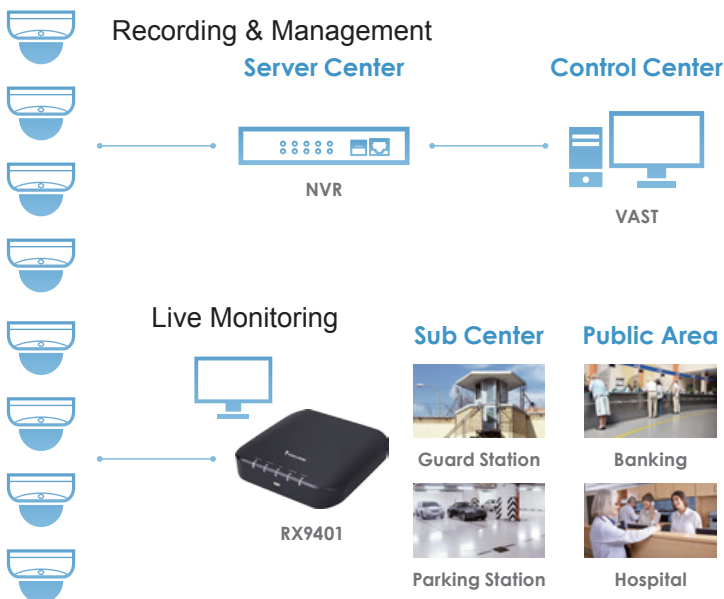
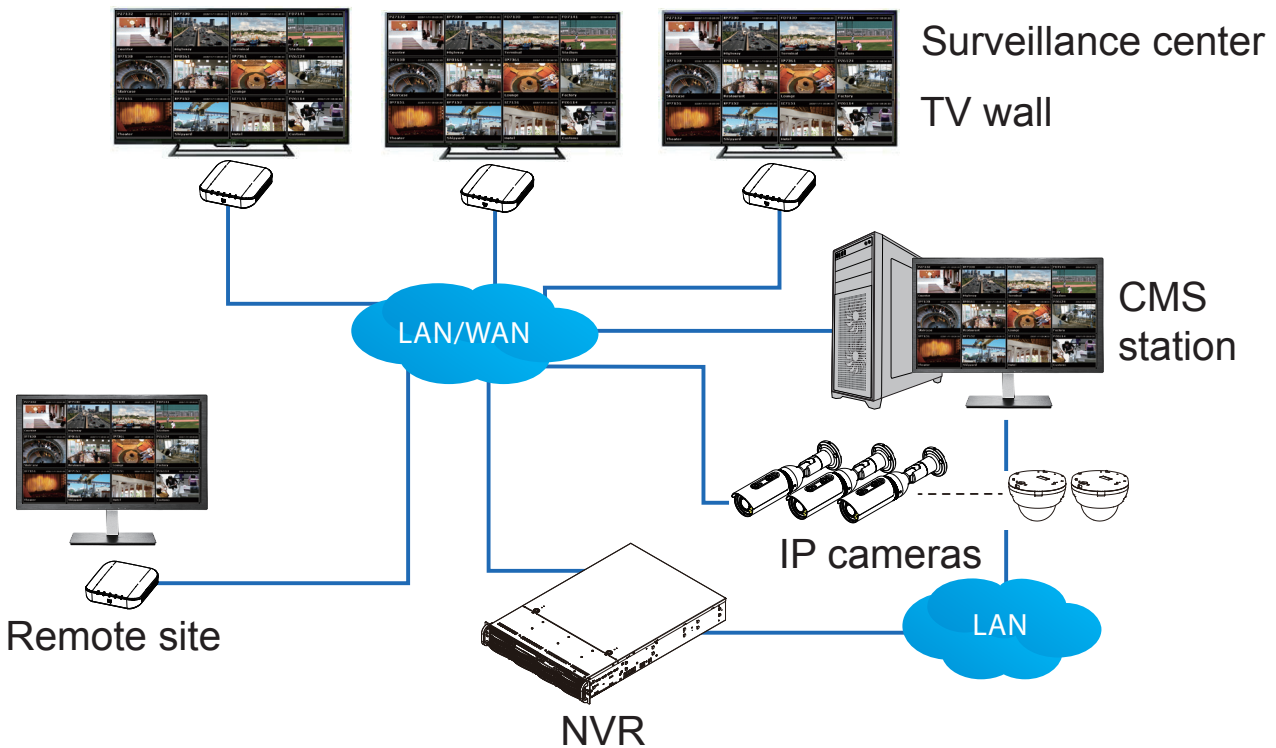

3 Hardware Installation

1. Connect a mouse and/or keyboard to the USB connectors at the front or the rear of the receiver.

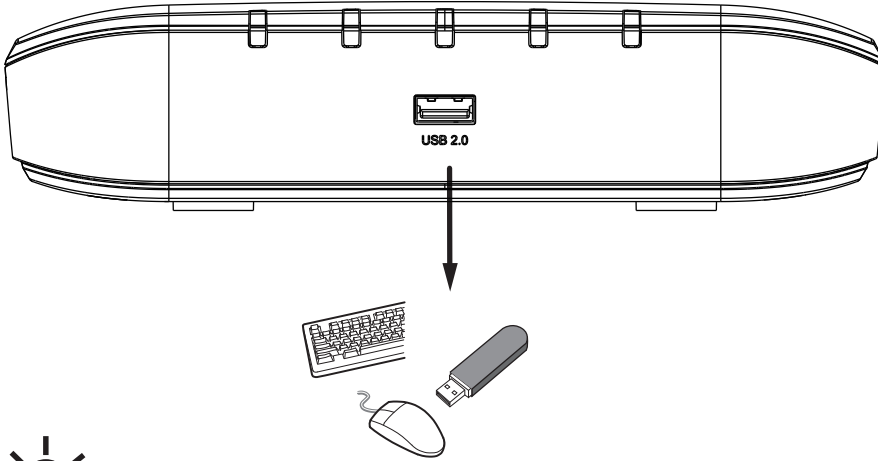

If you prefer to hang the Receiver on wall, drill and install two screws 104mm apart.

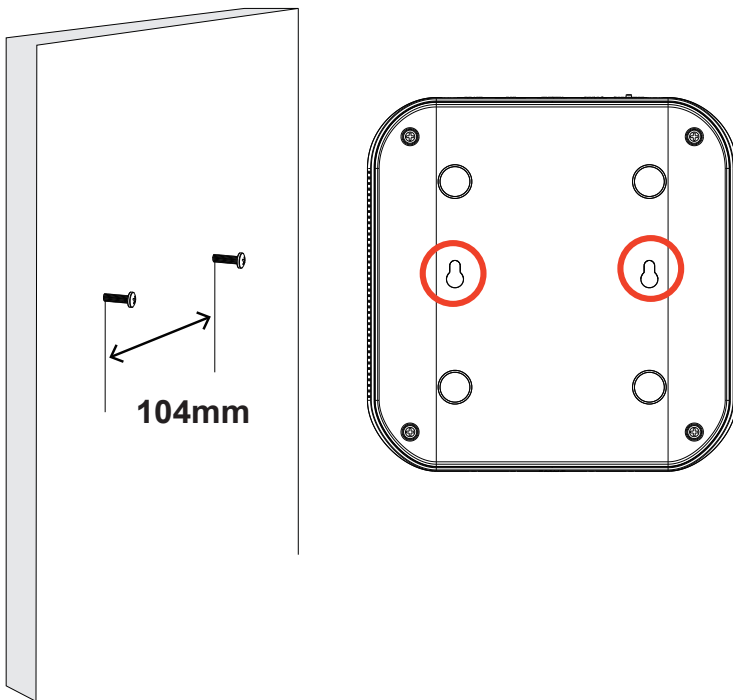

4 Interface Connections

1. Connect to a monitor using an HDMI cable.
2. Connect CAT5e or better-quality Ethernet cable to the network.
3. Connect USB devices such as mouse, keyboard, or USB thumb drive (formatted in FAT format), or UPS.
4. Connect the power adaptor to the power mains and the system.

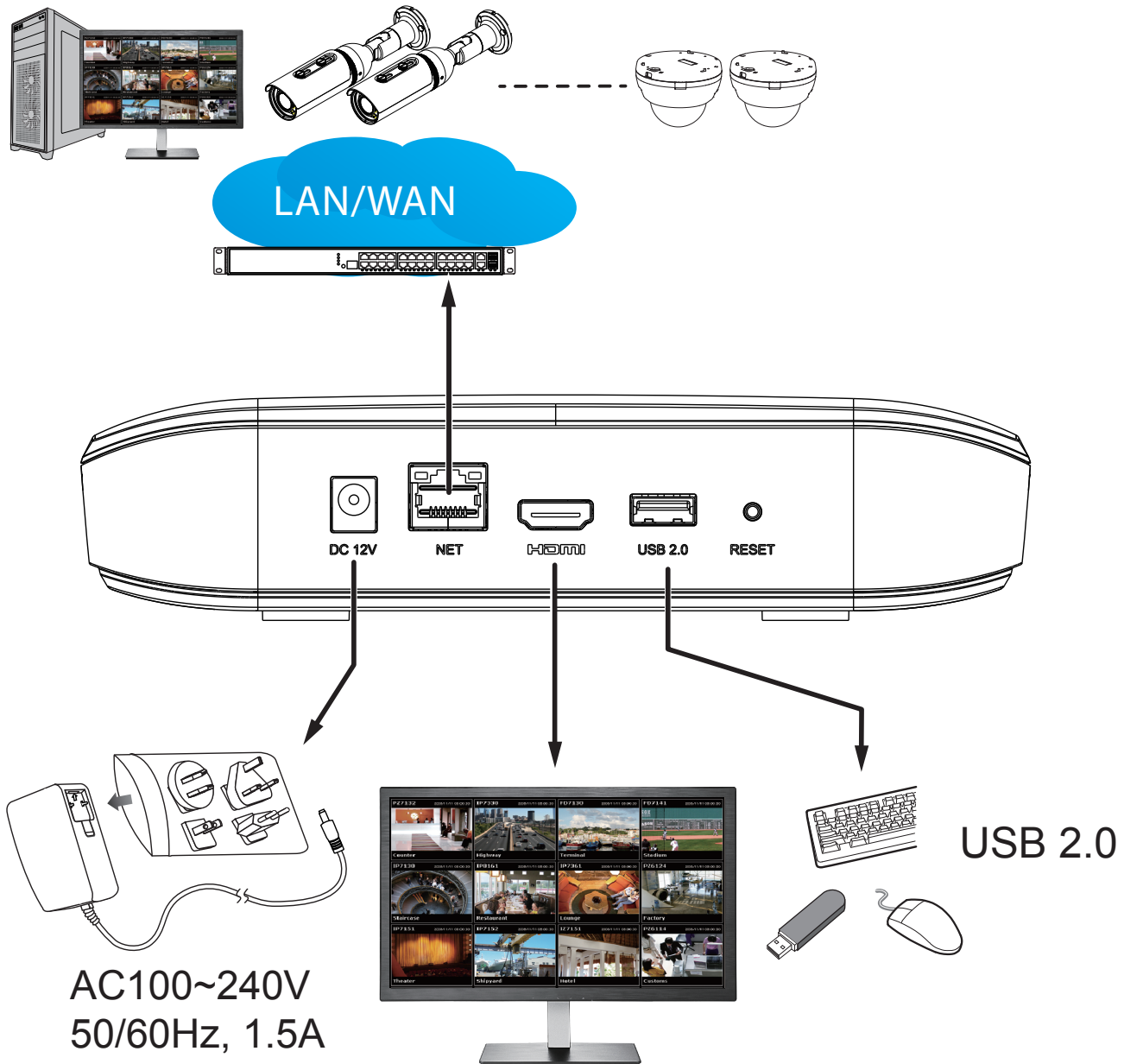

Pressing the Reset button for longer than 10 seconds will restore the factory defaults.

5 Initial Configuration - via a Local Console

A local console requires the following:

1. A monitor or TV is connected via an HDMI cable.
2. A mouse and/or a keyboard are connected to the system.
3. It is presumed that the system has not been configured yet. The Installation wizard only appears for an unconfigured machine or one that was restored to its default.

Follow the onscreen messages to complete the initial configuration:

1. When started for the first time, the system will prompt for the forceful configuration of a password. This ensures security from malicious network attack.

The applicable alpha-numeric characters are [0-9][a-z][A-Z][!][\$][%][-].[][@][^][_][~], with a max. length of 64 characters.

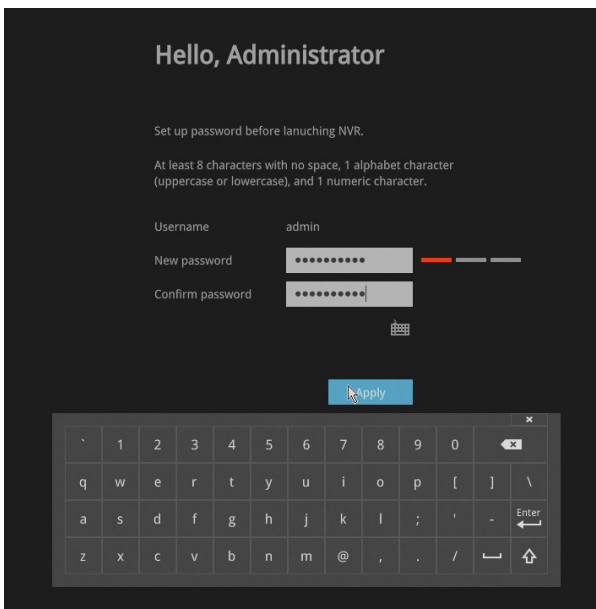

Click the **Apply** button when the new password is accepted.

2. Select the UI language, Time zone, and current date and time. Click on the **Continue** button to proceed.

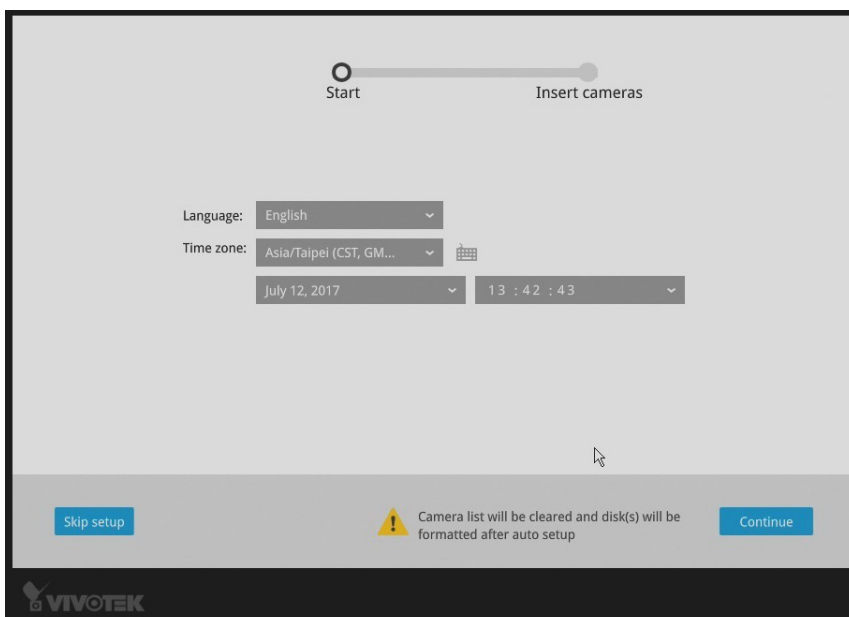



IMPORTANT:

Except in the initial setup, changing system time can produce disruptions to the existing recordings. Turning the current system time back to a time when video recording was taking place can generate duplicate files. And those files may not be playable.

3. The system will then start to scan the local subnet for connected cameras.

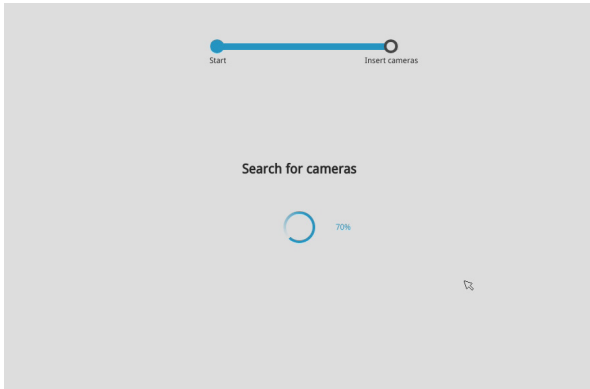

4. All cameras detected on the network will be automatically listed. If necessary, deselect the cameras you want to exclude from the configuration.

Cameras properly installed in the same subnet should all be listed. If you cannot find a camera, examine its network connections or network configuration.

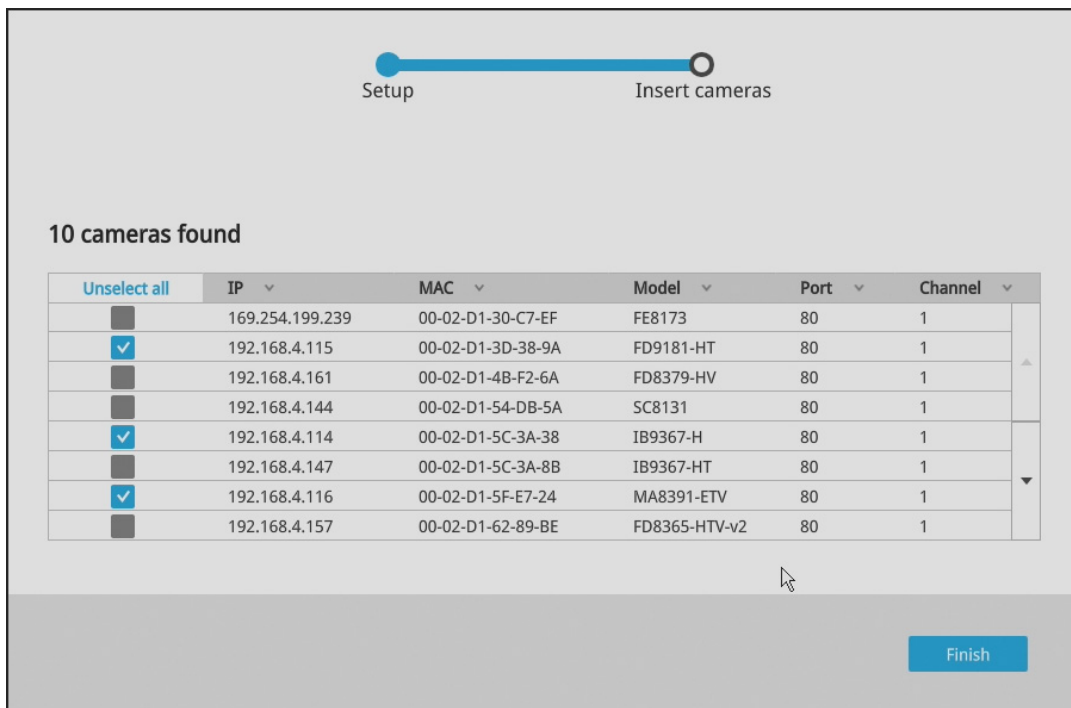

Enter the credentials for each selected cameras on screen. Click **Finish** to proceed.

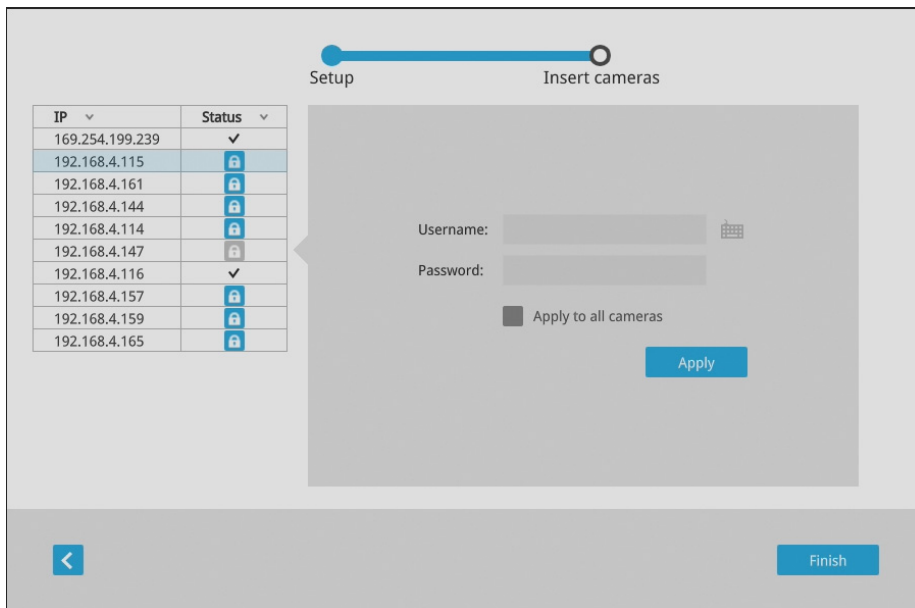

 **NOTE:**

1. The resolution and fps (frame rate per second) of stream 1 may vary depending on the specifications of different cameras.
2. Up to two clients viewing 2x 720P streams is acceptable. If more clients are simultaneously viewing more video streams, the machine can be stressed.

 **NOTE:**

Although the system supports MAC Binding, the system should be able to detect VIVOTEK's cameras within the network regardless of the presence of a DHCP server. Ideally, cameras and the Receiver should reside in the same subnet. If a camera's IP is changed for some reasons, the system should be able to detect its new IP.

6 Initial Configuration - via a Web Console (Optional)

1. Connect the power cord to start the Receiver. Wait for the system status LED to light green.
2. From a management computer, download and execute the **Shepherd** utility software. Follow the onscreen instructions to complete the installation.

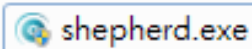

3. Start the Shepherd utility. The Shepherd utility will discover the Receiver located in the same subnet.

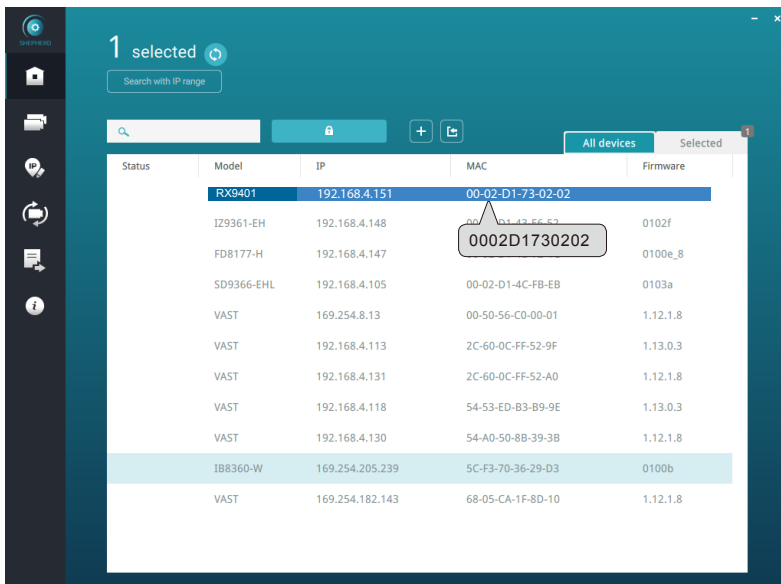

Status	Model	IP	MAC	Firmware
	RX9401	192.168.4.151	00-02-D1-73-02-02	
	IZ9361-EH	192.168.4.148	00-02-D1-43-FF-53	0102f
	FD8177-H	192.168.4.147	0002D1730202	0100e_8
	SD9366-EHL	192.168.4.105	00-02-D1-4C-FB-EB	0103a
	VAST	169.254.8.13	00-50-56-C0-00-01	1.12.1.8
	VAST	192.168.4.113	2C-60-0C-FF-52-9F	1.13.0.3
	VAST	192.168.4.131	2C-60-0C-FF-52-A0	1.12.1.8
	VAST	192.168.4.118	54-53-ED-B3-B9-9E	1.13.0.3
	VAST	192.168.4.130	54-A0-50-8B-39-3B	1.12.1.8
	IB8360-W	169.254.205.239	5C-F3-70-36-29-D3	0100b
	VAST	169.254.182.143	68-05-CA-1F-8D-10	1.12.1.8

4. Double-click on the RX9401 entry to start a web session with the Receiver system.

5. If you have configured a user name and password on the local console, use them to log in. Ideally, the initial configuration is performed via the local console. Expand the menu on the right of the Login button. Select and click on the **Settings** button to begin your configuration.

If accessed for the first time and no password has been configured, enter **admin** and **admin** as user name and password.

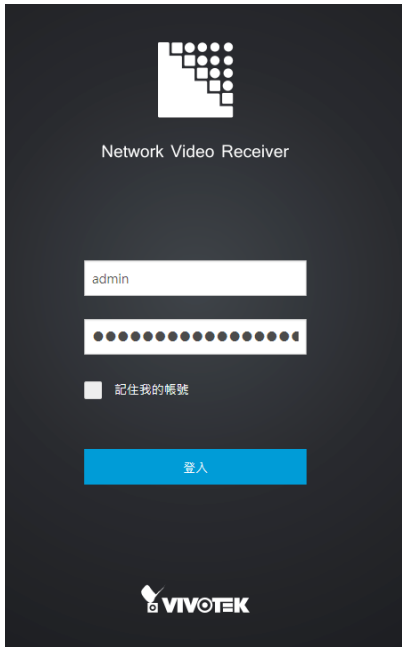

6. Refer to the later discussions for the rest of the configuration procedure.

7

LED Indicators

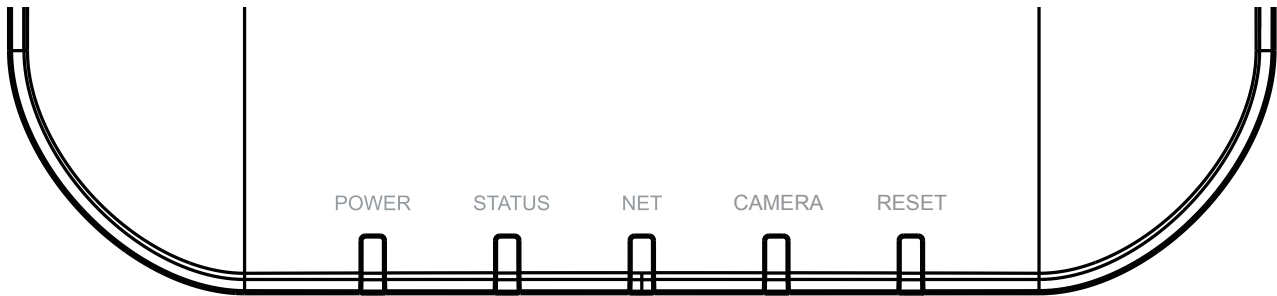

Name	Behavior	Definitions
1. Power	1 OFF	Powered down.
	2 Solid Green	Device is up and running.
2. Status	1 Green solid	System is ready.
	2 Blinking Red every 1 second	Firmware or device pack is being updated.
3. NET	1 OFF	The Ethernet port is disconnected.
	2 Orange blinking	Data is being transmitted and received.
4. Camera	1 Solid Green	All configured cameras are online.
	2 Solid Red	One or more configured cameras is disconnected.
	3 OFF	No camera is connected.
5. Reset	1 Blinking Blue	Reset or Restore to default is taking place.
	2 OFF	Normal status.

8 Power Up and Power Down

To power up and power down,

On the initial configuration:

Connect the power adapter between the system and power outlet.

After the initial connection,

Press the software power down button on the management session to power down. the system should start flushing the cached contents in system memory and gracefully shut down.

Once powered down, you need to re-connect the power cord to start the Receiver again.

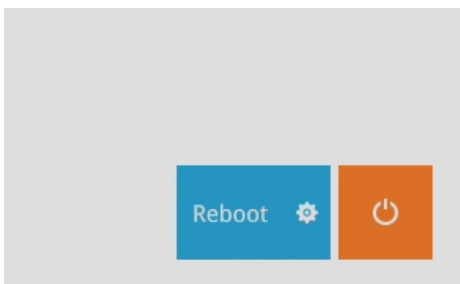

Section One

Management over a Local Console

Chapter Two

Introduction to the Local Console Interface

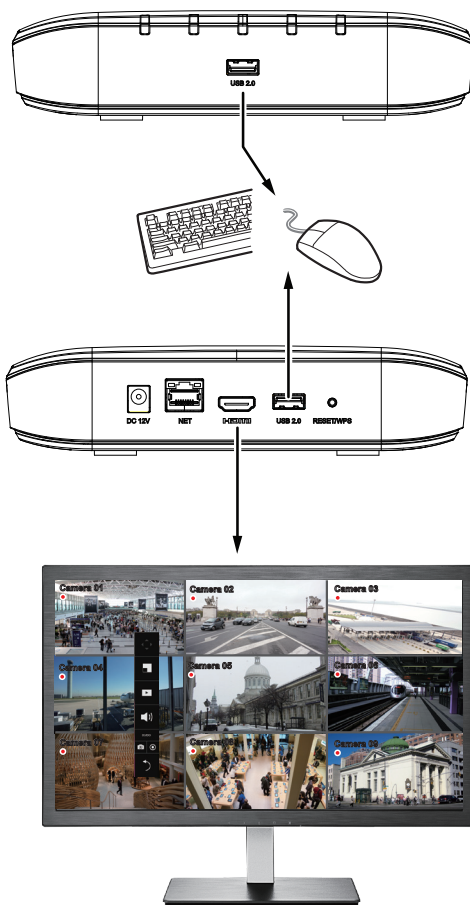

By default, a live view appears on an HDMI monitor. The interface architecture of the local console is illustrated as follows:

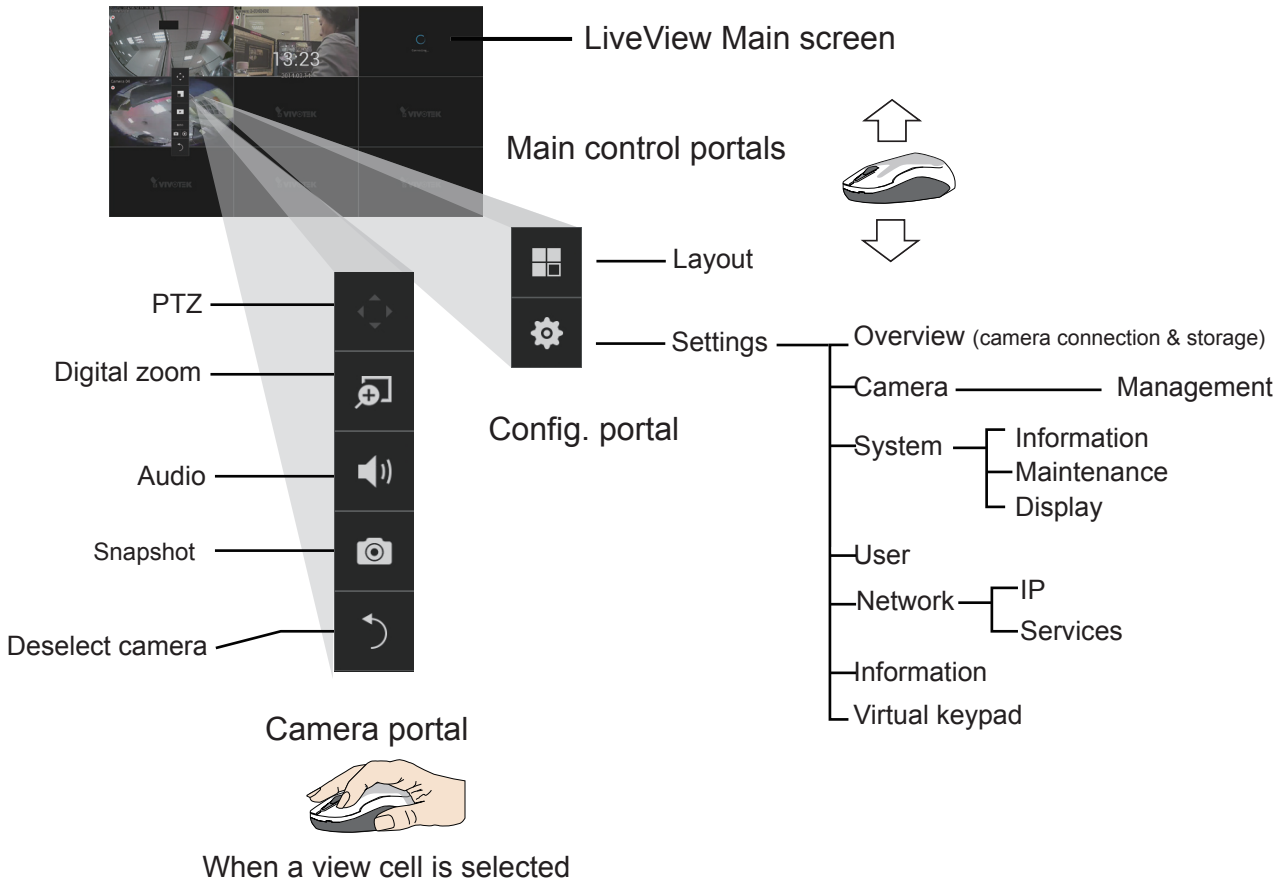

! IMPORTANT:

Due to the limitation of system resources, the fisheye dewarp (1R & 1P modes) can only take place on one view cell, for one fisheye camera.

2-1. How to Begin

1. How to access the Configuration Portal?

Make sure a mouse is attached to your Receiver. Move your mouse cursor, and the Configuration Portal will appear on screen. For all the configurable options available through this portal, please refer to Chapter 3 on page 32.

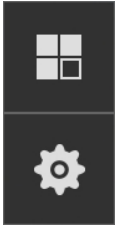

You can also hide these portal toolbar. Right-click on the LiveView screen to display the option.

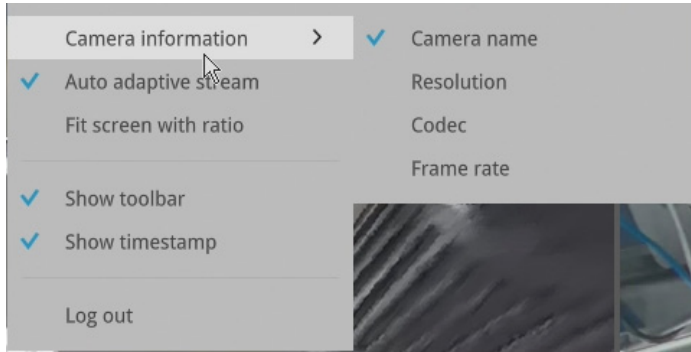

2. How to access the Camera Portal?

Single click to select a view cell, the Camera Portal will appear. The system automatically detects the characteristics of an individual camera when you select a view cell.

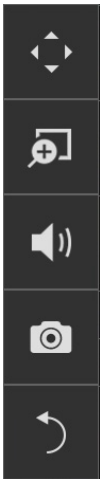

This portal appears with a camera that supports mechanical PTZ.

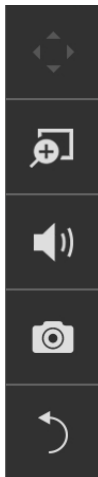

This portal appears with a camera that does not support mechanical PTZ.

Tips:

Here are some operation steps using the tool bar:

1. Single-click to select a view cell and bring out the tool bar.
2. Double-click to expand a view cell to the full view.
3. Double-click again to shrink the view cell to the original size.

PTZ control panel for ordinary PTZ type

PTZ control panel for joystick type PTZ

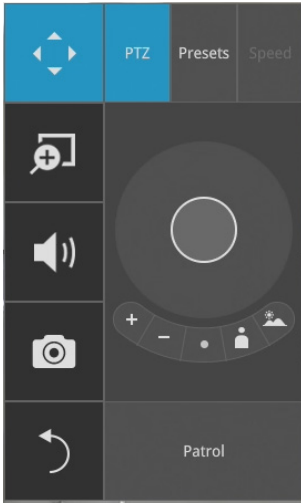

5. Why live view is unavailable?

The default live view receives a camera's stream #2. If a camera's stream #2 is configured using MPEG-4 as the video codec, the following message will prompt.

You can use the Shepherd utility to locate the camera and open a web console with the camera. Go to the **Configuration > Media > Video** window to configure the video codec of stream #2 into H.264 or H.265.

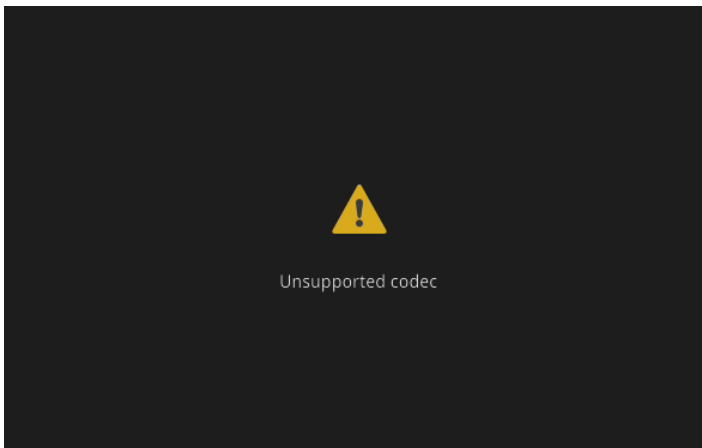

VIVOTEK
www.vivotek.com

Home Client settings **Configuration** Language

Media > Video

System
Media
Image
Video
Audio
Network
Security
PTZ
Event
Applications
Recording
Local storage

Version: 0100c_g

Stream

Video settings for stream 1 [Viewing Window](#)

H.265

Frame size: 1920x1080

Maximum frame rate: 30 fps

Intra frame period: 1 S

Smart stream II

Dynamic intra frame period ([Help](#))

Smart codec:

Mode: Auto tracking

Quality priority: ([Help](#))

Bit rate control

Constrained bit rate:

Fixed quality:

Quality: Good

Maximum bit rate: 6 Mbps

H.264

JPEG

Video settings for stream 2 [Viewing Window](#)

Video settings for stream 3

Save

6. How do I move to another layout page?

Move your cursor to the right hand side of your screen. The page turner buttons will appear as shown below.

For example, if you have 8 cameras placed on 2 2x2 layout pages, use these buttons to visit different pages.

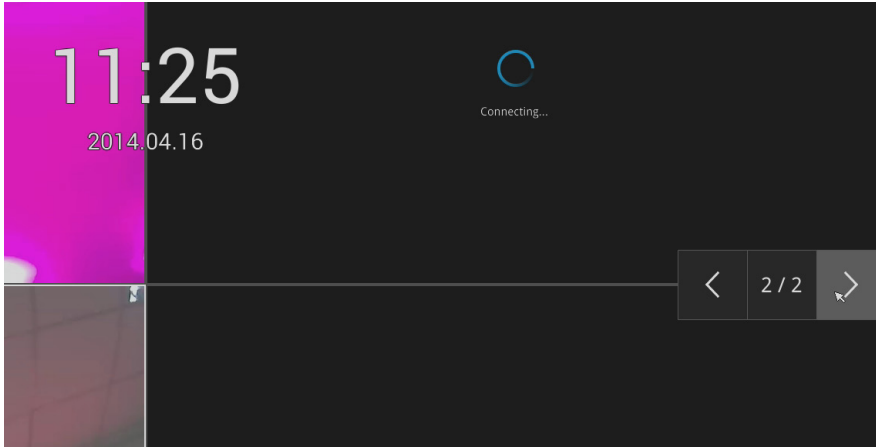

7. Why the onscreen tool bars disappear after some time?

The system comes with idle modes. Below are the applicable conditions:

1. **Live view**: if no management activities occur for 5 seconds, the tool bars disappear from screen. When in the idle mode, mouse cursor and tool bars will disappear. Moving the mouse cursor will re-activate the screen.
2. **Settings** page: If left unattended for 10 minutes, system will automatically log out. The system will prompt for user credentials if a user tries to access the Settings page again.

2-2. Operation on a Camera View Cell

The following apply when a camera view cell is selected.

2-2-1. PTZ Panel

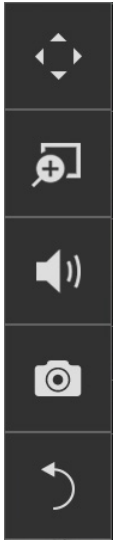

Once you selected a camera, click on the PTZ button on a camera portal.

The PTZ panel will prompt. Below are the description of its functions:

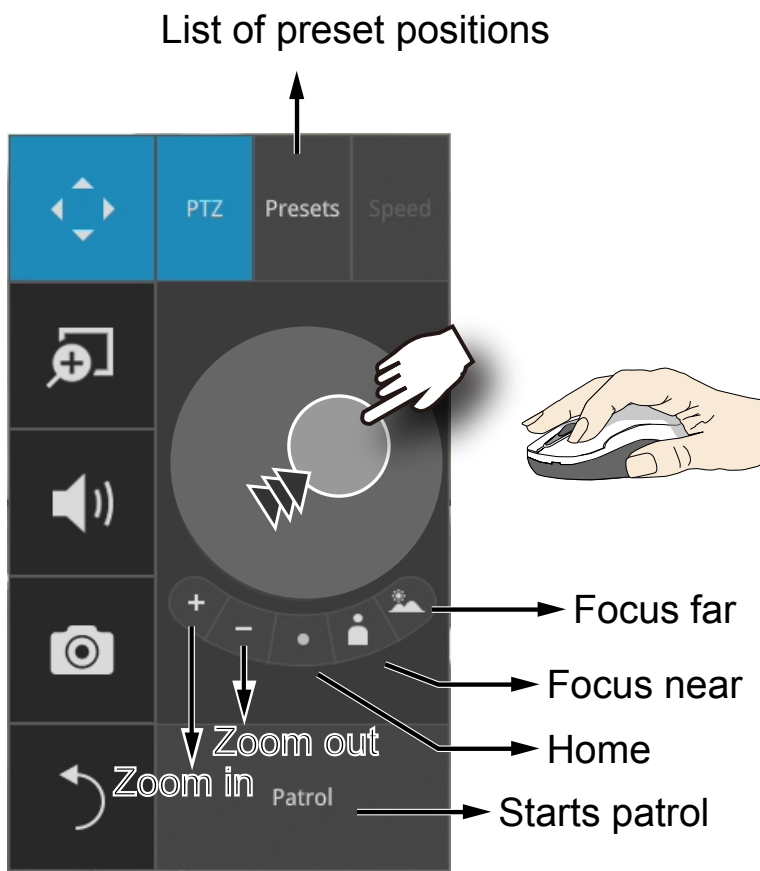

1. **PTZ control:** Click and drag the nudget in the center towards the direction you wish to move to.
2. **Focus:** Click on the Focus near and Focus far buttons to adjust camera focus.
3. **Home:** Click to move the camera lens towards the default home position.
4. **Zoom:** Use the Zoom in and Zoom out buttons to adjust the camera's zoom ratio.
5. **Presets:** If you configured preset positions, a list of preset positions will appear.
6. **Patrol:** If you configured preset positions into a patrolling tour, click on this button and the camera will proceed with patrolling through preset points.

Note that on a speed dome camera, the farther you pull the nugget away from the center, the faster the lens moves. This works like speed control.

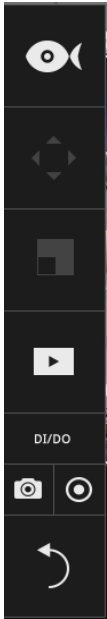

This portal appears with a fisheye camera. The PiP and PTZ buttons will then be disabled for a fisheye camera.



IMPORTANT:

Due to the limitation of system resources, the fisheye dewarp (1R & 1P) can only take place on one view cell, for one fisheye camera.

Joystick support



The joystick related operations are listed below:

1. **Pan**: Continuous move is supported. (joystick X-axis movement)
2. **Tilt**: Continuous move is supported. (joystick Y-axis movement)
3. **Zoom**: Continuous move is supported. To zoom in, move joystick Z-axis clockwise. To zoom out, move joystick Z-axis counter-clockwise.

The Receiver supports VIVOTEK's IPD-USB(3-axis, 12 buttons), AJ-001(3-axis, 8 buttons), and AJ-002 (3-axis , 29 buttons) joysticks.

The default button functionality are described below:

Button	Function	Note	Live	Setting	Playback
1	Pan		V	V	-
2	Patrol	Supports the first patrol	V	V	-
3	Stop		V	V	-
4	Home		V	V	-
5	Focus Near		V	V	-
6	Focus Far		V	V	-
7	Snapshot		V		V
8	Preset		V	V (PTZ setting/ Motion only)	-
9 ~ 17,19	Number 0~9		V	V (PTZ setting/ Motion only)	V
18	ESC		V	V	V
20	Enter		V	V (PTZ setting/ Motion only)	
21	Full screen	When a view cell is selected, also applies in the Playback. Press the second time to return to previous state.	V	-	V

22	Manual Recording	Press once to start manual recording. Press the second time to stop.	V	-	-
23	Change Layout	Consecutively changes layout	V	-	V
24	Rewind		-	-	V
25	Pause		-	-	V
26	Play		-	-	V
27	Speed Up		-	-	V
28	Slow down		-	-	V
29	Change focus view	In live view/playback layout, will move from top left to lower right, from view cell to view cell.	V	-	V

Multi-key Combinations

Button	Function	NOTE	Live	Setting	Playback
Number+ Enter	Turns a channel into full view (AJ002 only)	None responsive if unconfigured channel number is entered; e.g., 9+Enter on an 8-CH Receiver.	V	-	V
Preset+ Number + Enter	On a PTZ camera view cell, moves to a preset position (AJ002 only)	None responsive if unconfigured position number is entered	V	V (PTZ setting/ Motion only)	-
Preset + Number	On a PTZ camera view cell, moves to a preset position (AJ001)	None responsive if unconfigured position number is entered	V	V (PTZ setting/ Motion only)	-

2-2-2. Digital Zoom Panel

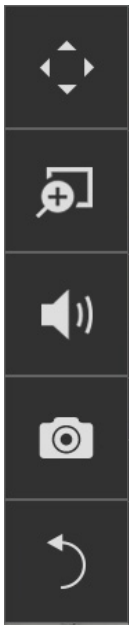

Digital zoom is a function that allows an operator to zoom in or zoom out on a live video.

When activated, a **Global view** window will appear at the lower right of the view cell as shown below. You can display only a portion of the complete video frame as an area of your interest. Using a click and drag on the **ROI** window, you can instantly move to other areas within the video frame. Use the zoom ratio pull bar at the bottom to change the zoom ratio. You may also move the ROI around by clicks and drags.

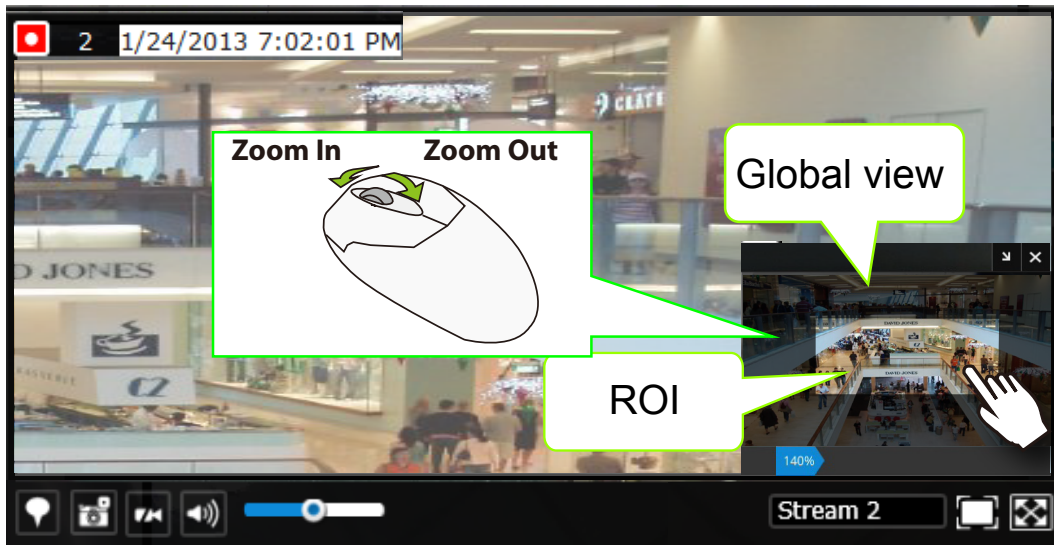



Note that not every camera supports the PiP function.

2-2-3. Others

1. **Snapshot** : is used to take a snapshot from the camera currently selected. Note that this function only saves the snapshot (in JPEG) to a USB thumb drive.

IMPPOINTANT:

The USB thumb drive has to be one that is formatted in FAT format.

2. **Manual Recording** : Press the button to start a manual recording from a selected camera. Click again to stop the recording.
3. **Return** button : Click to return to the LiveView window.

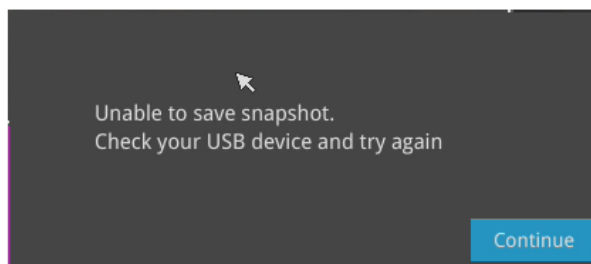
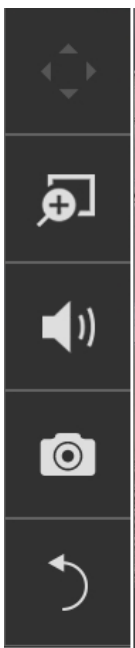

2-2-4. Right-click Commands

Left-click to select a camera. Right-click to display the selection menu.

1. **Camera information:** Click to display camera name, resolution, codec, or frame rate on the view cell. The information will display on the upper left corner of a view cell.
2. **Auto adaptive stream:** Default is enabled. The Auto adaptive stream automatically polls a video stream of a smaller resolution (changing the resolution of stream #2) in order to reduce the streaming efforts. For example, when a view cell is placed in a 3x3 monitor layout, it may not be necessary to stream the video in its full resolution. In a full view, the system displays a video in its full resolution. Due to the size of view cells on your monitor, when in a multi-cell layout, the system automatically polls the camera for a smaller resolution stream.

The Auto adaptive stream feature can be disabled if you prefer consistent display resolution.

3. **Fit screen with ratio:** The Receiver server automatically optimizes the display camera view cells. However, you can still select this option to display the camera's original aspect ratio: for example, the original video feed can be 4:3. Without the fit screen, every camera's image will be expanded to fill the view cell.
4. **Show tool bar:** You can hide the tool bars by deselecting this option.
5. **Show timestamp:** You can hide the time stamp bars by deselecting this option.
6. **Log in:** Log in to enable system configuration.

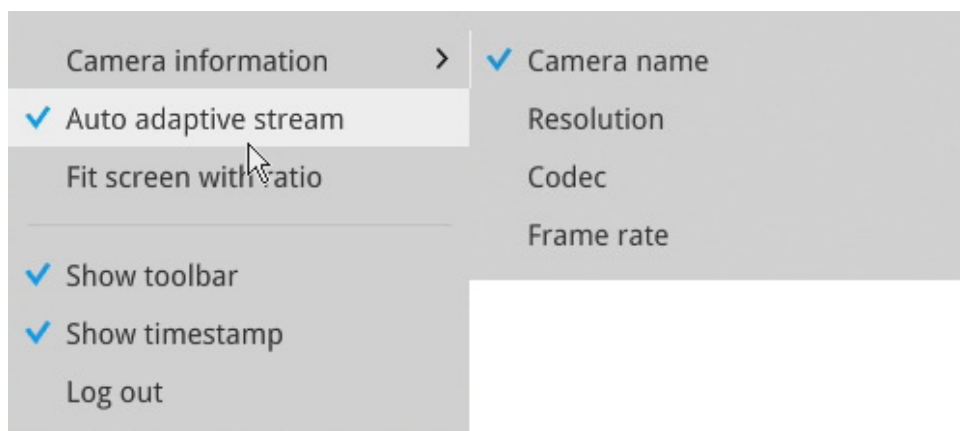

Chapter Three

Configuration Using the Local Console

The Main Control Portal

3-1. Layout

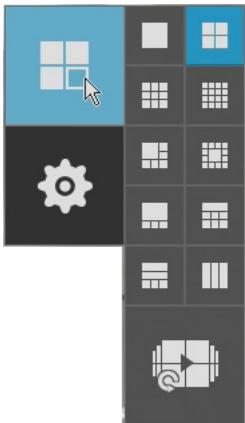

Move your mouse cursor across the screen to display the portal.

The first functional button is Layout. You can select the 1x1, 2x2, 3x3, 4x4, 1M+5, 1M+12, 1P+3, 1P+6, 2P+3, 3V layout as the screen display. If you select the single view layout, the rotation button  will appear. Click the rotation button below to let the system swap the display of different cameras by every 10 seconds. The rotation speed is configurable via Settings > System > Display.

3-2. Settings

3-2-1. Settings - Overview



Click the **Settings** button to start the camera and system settings window. A confirm box will prompt. Enter User name and Password to proceed.

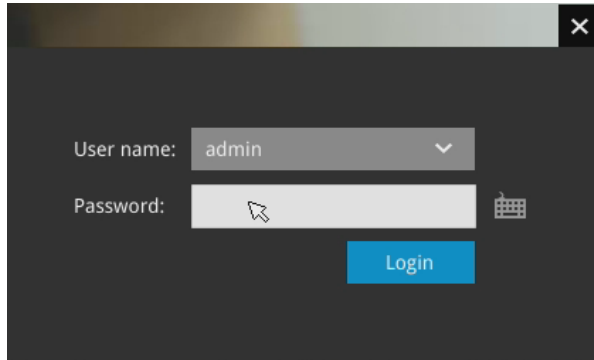

The system will default to the overview page displaying the camera connection statuses. An empty position will be left in blank, and a disconnected camera will be indicated as .

The **Reboot**, and **Power-down** buttons are also available on this page.



The Camera menu provides access to **Management, Recording, Media, Image, Motion detection, and PTZ settings** pages.

3-2-2. Settings - Camera - Management

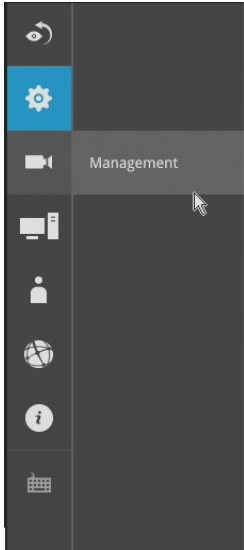

On the camera Management page, you can configure the following:

1. Recruit or disband cameras.
2. Assign User name and Password, or apply the credentials to all cameras in your configuration.
3. Change the Network settings.
4. Change the cameras' positions on the layout screen.

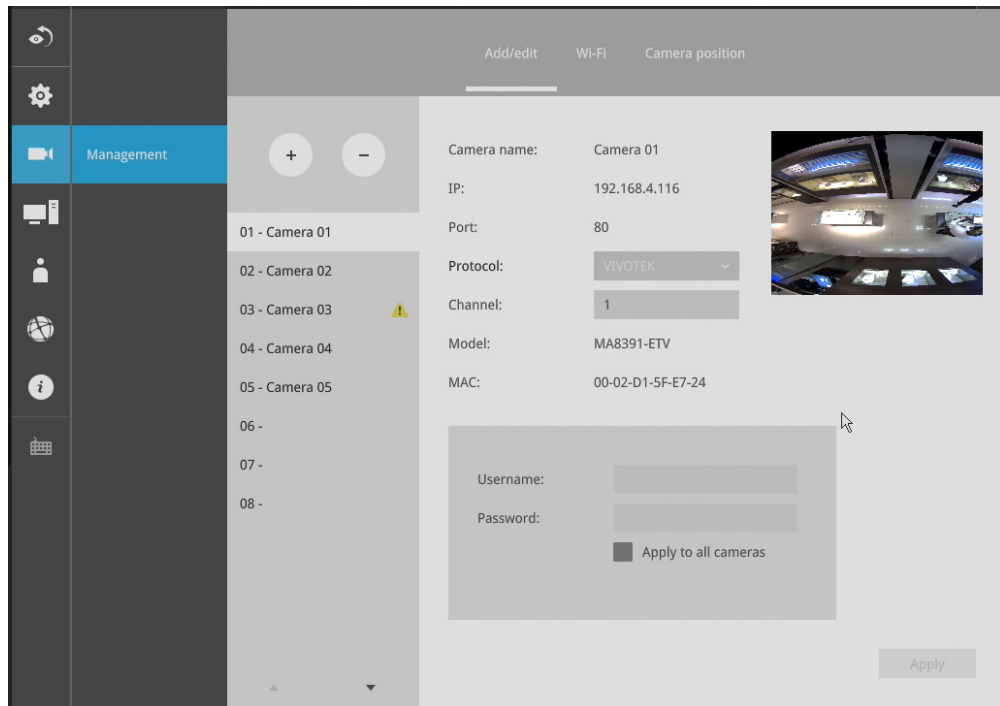

To recruit cameras:

1. Click on the Add  button. A list of cameras in the same subnet will appear.

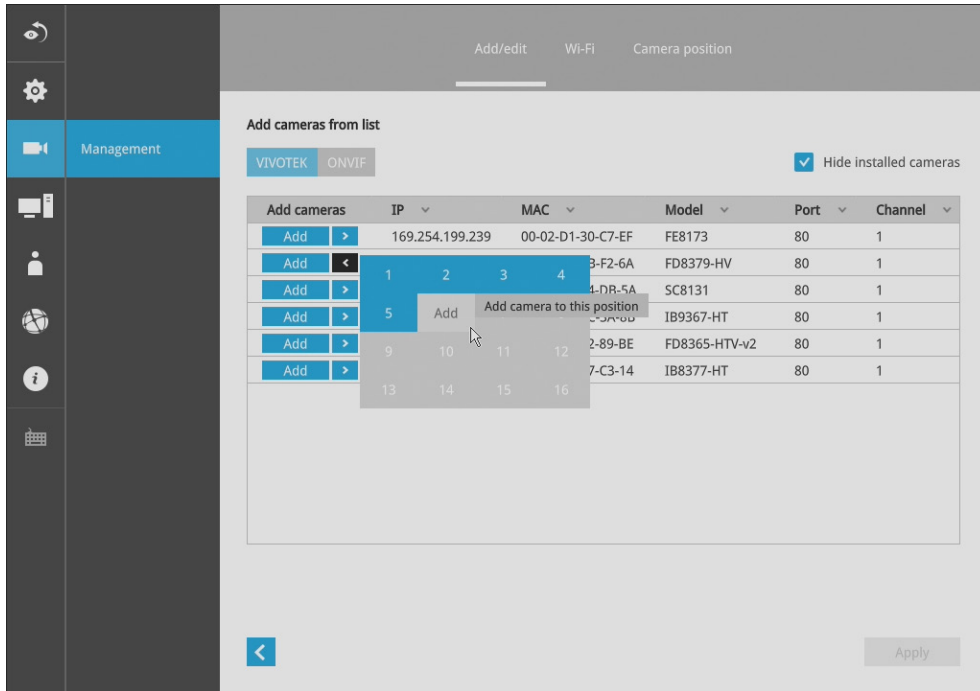

2. Click the **Add** button, the camera will be placed at an unoccupied position. You may also expand the menu on the side of the Add button to select a position number.
3. When a camera is added, it should appear on the graphical placement below.
4. Click the Apply button after you added cameras.
5. You may click the page back button  to return to the previous window.

To disband cameras:

1. Click on the **Remove**  button. A list of cameras in your configuration will appear.

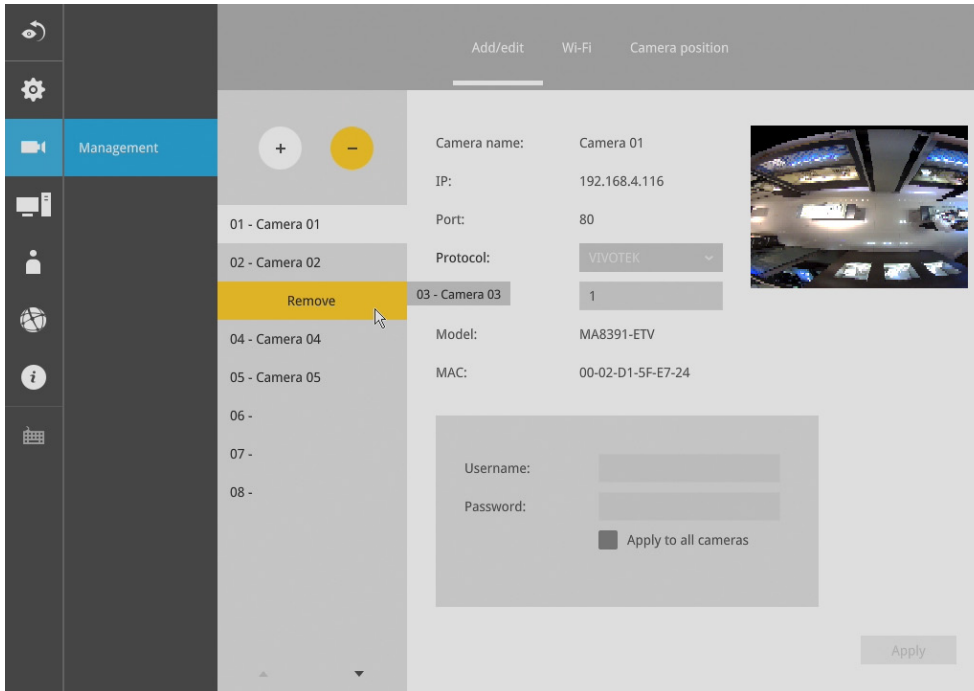

2. The **Remove** button will turn yellow . Mouse over to the camera you want to remove, and its entry will display the **Remove** message.
3. Click on the Remove message. The camera should then disappear from the camera list. The live stream coming from that camera will also be discontinued.

Wi-Fi

If wireless cameras are recruited by the Receiver, its wireless connection details are shown in here.

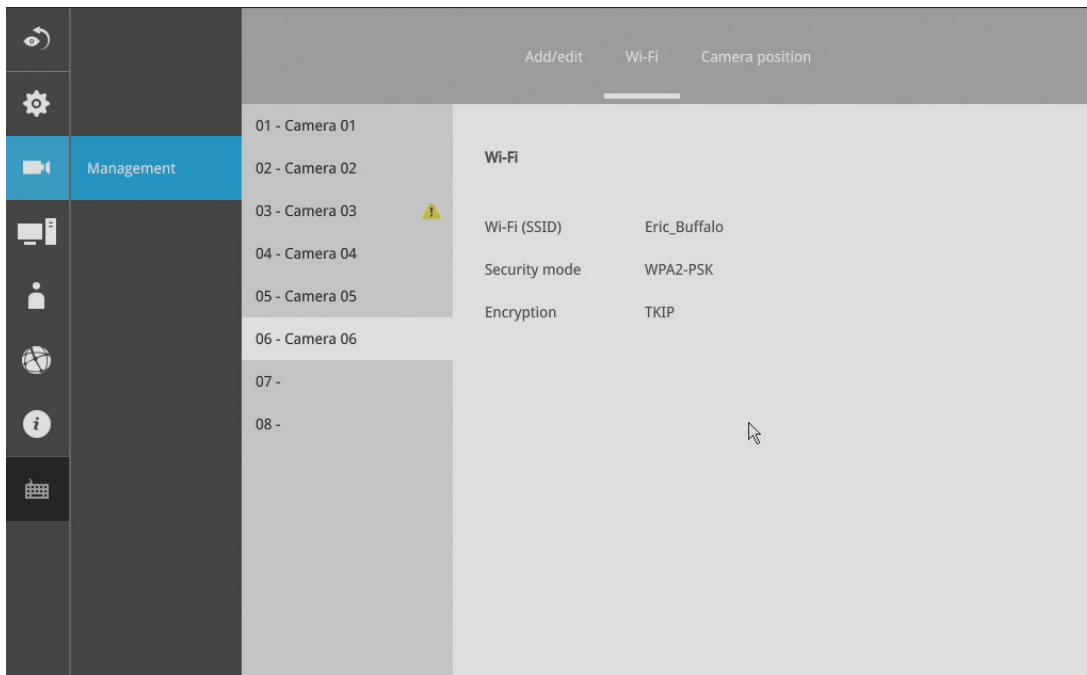

1. **Wi-Fi (SSID):** Displays the AP (Access Point) this camera is connected to.
2. **Security mode:** Displays the security mode used for the security encryption.
3. **Encryption:** Displays the encryption standard currently applied.

Camera position

To change a camera's position on the Liveview layout, click and drag a camera to an unpopulated position. Note that you cannot swap the positions of two cameras by dragging a camera onto a position already populated by the other. Also, the camera index number on the management list is not affected by the change of positions.

Click the **Apply** button for the configuration change to take effect. The position screen displays the current layout on the Liveview screen.

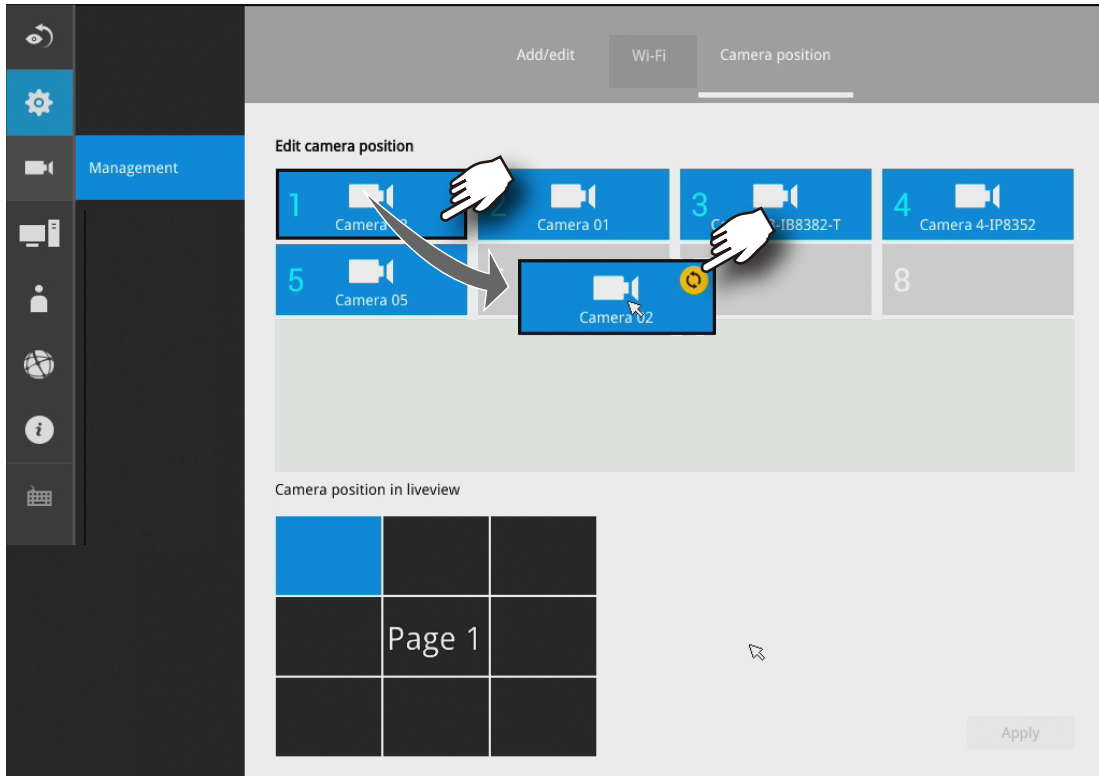

3-3-1. Settings - System - Information

On this window, you can configure the following:

1. Change the system name.
2. Select the UI text language.
3. Configure system time, time zone, and if you are connected to a DNS server where Auto Daylight Saving time can be applied, you can acquire the associated setting from a server within your network.
4. Click the **Apply** button for the configuration to take effect.

Note that if **NTP** time server configuration (Auto) is preferred, the system will automatically configure all cameras to be listening to the system, and therefore to the same time server.

The screenshot shows the 'System - Information' settings page. On the left is a dark sidebar with navigation icons and labels: Information (highlighted in blue), Maintenance, Display, UPS, Log, and VIVOCloud Service. The main content area is light gray and contains the following sections:

- Name and language:**
 - System name: ND8422P
 - Language: English (dropdown)
- Time:**
 - Set system date and time: Manual setup (dropdown)
 - February 16, 2017 (dropdown) | 15 : 07 : 32 (dropdown)
 - Now (button)
- Time zone:**
 - Asia/Taipei (CST, GM... (dropdown)
 - Auto setup Daylight Saving Time (button)

Below the 'Time zone' section, there is a note: 'Set up Network - IP - DNS server to update Daylight Saving Time'. A 'Manual setup' box contains the following steps:

- 1 Download update file from <https://www.iana.org/time-zones>
- 2 Save file to USB device
- 3 Import file to update (button)

An 'Apply' button is located at the bottom right of the settings area.



IMPORTANT:

Changing system time can produce disruptions to the existing recordings. Turning the current system time back to a time when video recording was taking place can generate duplicate files. And those files may not be playable.

3-3-2. Settings - System - Maintenance

If the need arises for updating system firmware, acquire the update from VIVOTEK's technical support or download site. Locate the firmware binaries, and click the Import button. The upgrade should take several minutes to complete. Note that during the upgrade, the recording task will be interrupted.

On this window, you can perform 4 maintenance tasks:

1. **Update firmware** - Download firmware and save it to a USB drive in the FAT format, attach the USB device to the Receiver for firmware upgrade.
2. **Update device pack** - A device pack allows you to import associated configurations and parameters for new camera models so that these cameras can be integrated into your Receiver configuration. The information in the device pack is related to some tunable parameters.
3. **Backup** - You can backup your system configuration using the Backup function. Click Backup, a message window will prompt. Click Save to preserve your system configurations.

Select a location for your backup file, then click Save to complete the process. If you back up to a USB thumb drive, that thumb drive must be formatted using the FAT format.

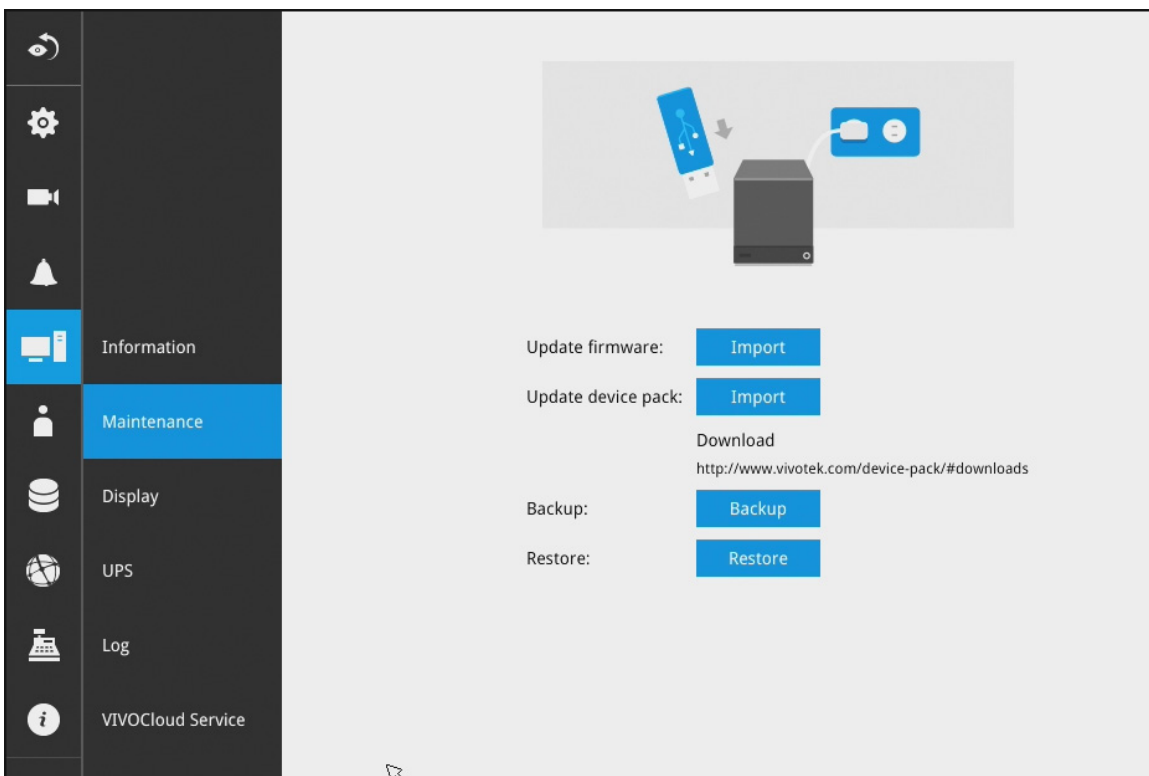

Note that the backup action does not involve the following:

1. Recorded videos and database,
 2. Alarm records, bookmarks, and bookmarked footages.
4. **Restore** - If you have a previously-saved profile, you can restore your previous configuration. Click the Restore button.

A file location window will prompt. Locate the backup file, and click Open. The Restore process will take several minutes to complete, and system operation will be interrupted during the process.

3-3-3. Settings - System - Display

On this page, you can configure the system to consecutively display (rotate) cameras' view cells on the Liveview window. For example, if you have 8 cameras in 2 2x2 layouts, the rotation can let you see the live views of all cameras by every few seconds.

You can also enable or disable the Alarm notification.

Output resolution: If your monitor or TV supports the 4K resolution, you can select the 4K resolution at the frame rate of 30fps. This setting depends on the maximum resolution of your display device.

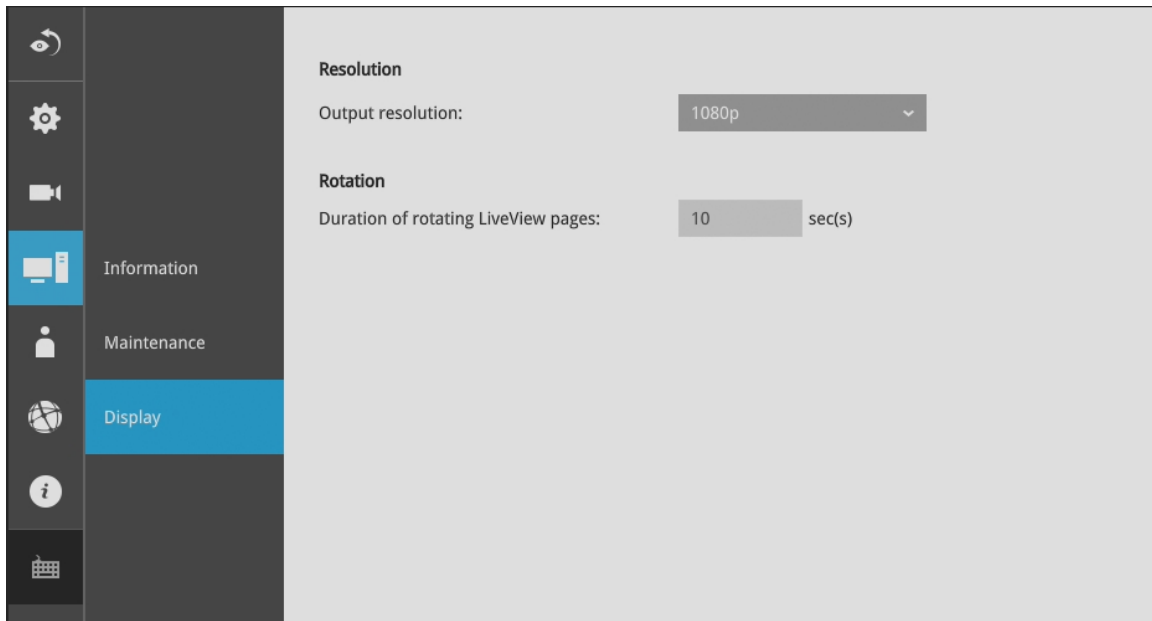

To enable the rotate function, click on the rotate button on the layout panel.

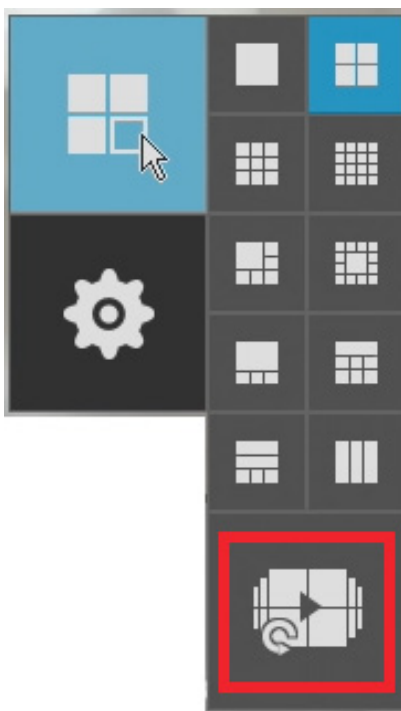

3-4. Settings - User

The User window allows you to change the administrator's password.

1. By default, there is only one user type: **Administrator**.
2. The administrator users can access all cameras recruited in the configuration.

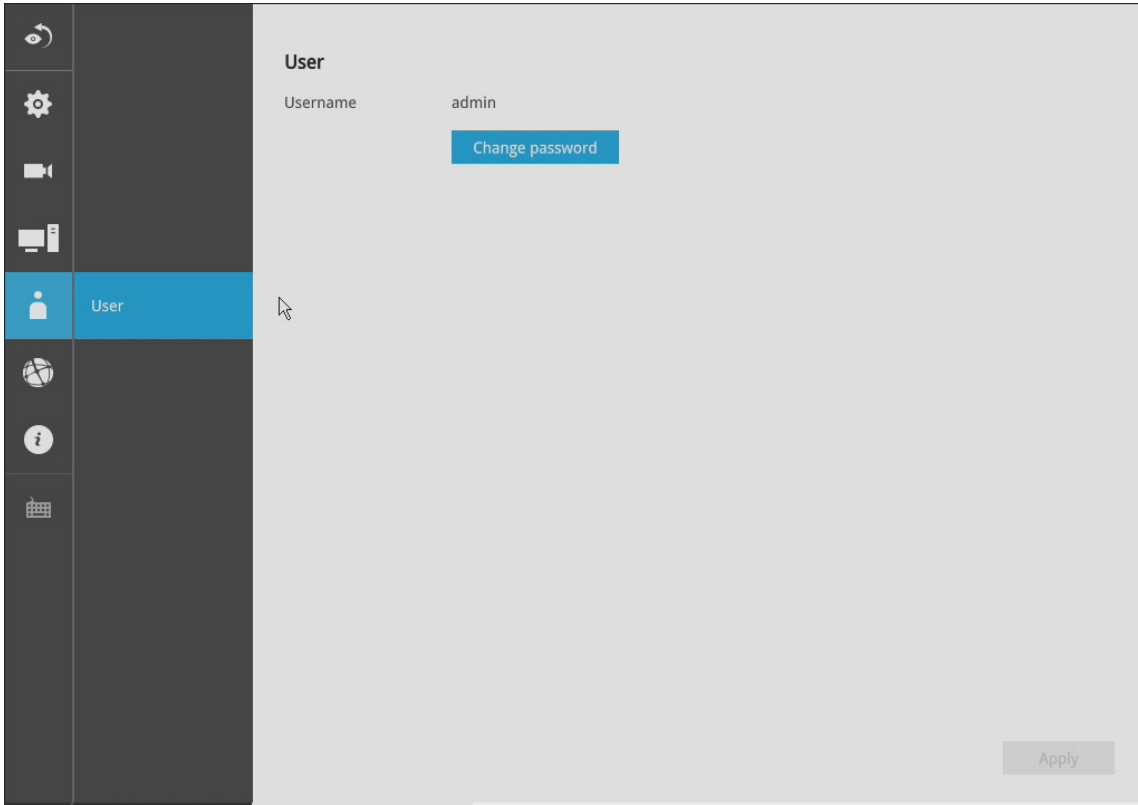

The max. number of characters for the administrator password is 64, with the combination of alphabetic and numeric characters including `[0-9][a-z][A-Z][_][][-].[,][@]`.

IMPORTANT:

It is highly recommended to change the default password to prevent unauthorized access to the system.

3-5. Settings - Network

Settings - Network - IP

DHCP: Default is selected, the server obtains an available dynamic IP address assigned by the DHCP server each time the system is connected to the LAN.

Manual setup: Select this option to manually assign a static IP address to the Network Camera.

Enter the Static IP, Subnet mask, Default router, and Primary DNS provided by your ISP.

Subnet mask: This is used to determine if the destination is in the same subnet. The default value is "255.255.255.0".

Default router: This is the gateway used to forward frames to destinations in a different subnet. Invalid router setting will fail the transmission to destinations in different subnet.

Primary DNS: The primary domain name server that translates hostnames into IP addresses.

Secondary DNS: Secondary domain name server that backups the Primary DNS.

When finished with the network settings, click on the **Apply** button.

IP Configuration:	Manual setup
IP:	192.168.4.153
Subnet mask:	255.255.255.0
Gateway:	192.168.4.1
DNS server 1:	192.168.0.21
DNS server 2:	192.168.0.22

Apply

Settings - Service

By default, the Receiver service and video streaming are accessed via HTTP port 80 and RTSP port 554. You can designate a different port number if the need arises. Usually it is not necessary to change these ports. HTTPS encrypted connection is enabled by default.

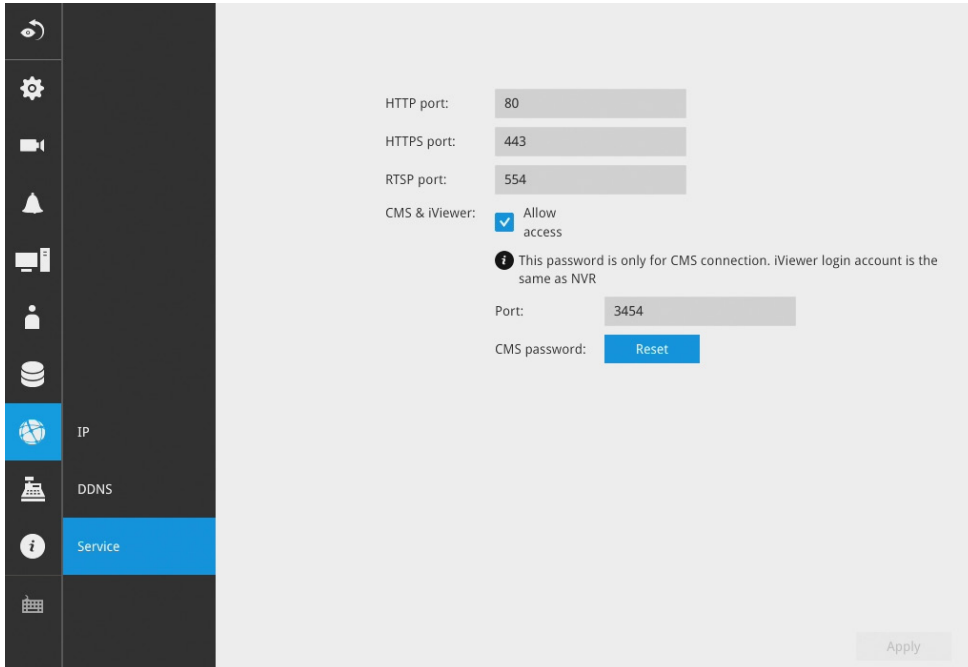

Instead of a web console, you can also access the Receiver and the subordinate cameras using VIVOTEK's **VAST** software. The Receiver can be managed as one of the sub-stations in a hierarchical device structure.

Set up a password for access from the VAST server before you can join the Receiver to a VAST centralized management configuration. For access from the iViewer, you log in using the same user name and password for the login to the Receiver.

Below is the screen showing the sub-station recruitment process from a VAST server.

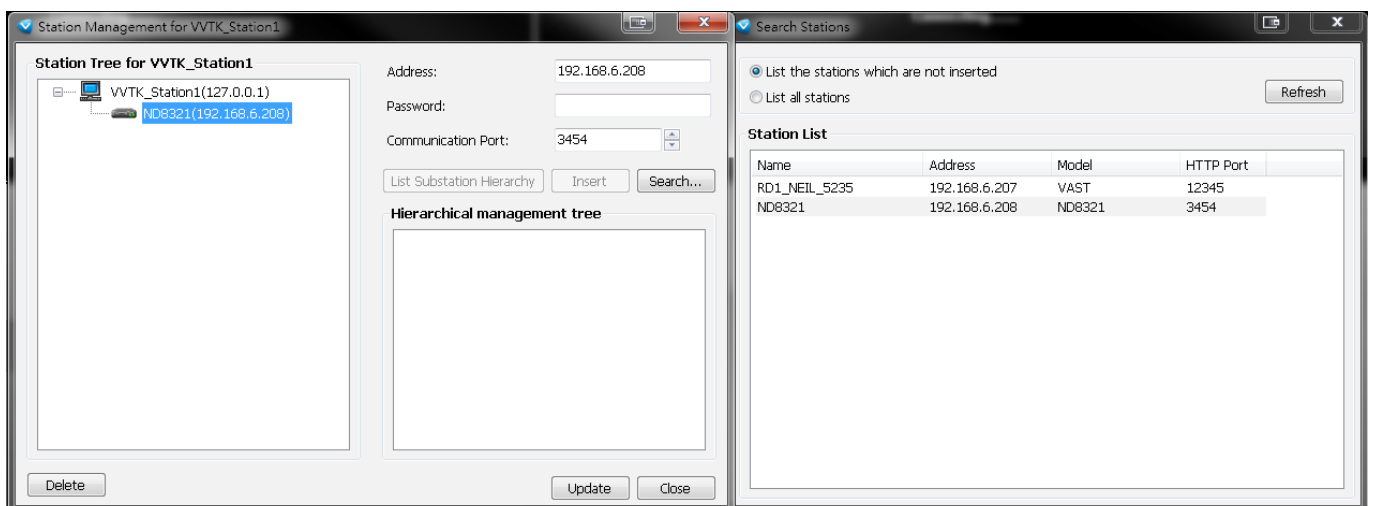

3-6. Information

This window shows the revision number of the firmware running on this machine.

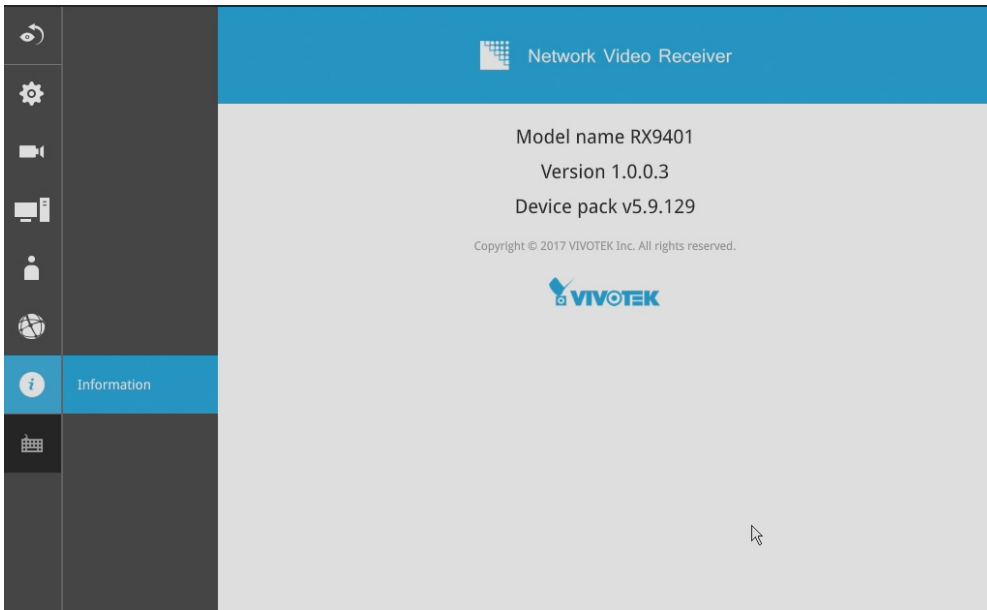

Section Two

Management over a Web Console

There are two different interfaces on the system:

1. One is connecting mouse and keyboard, and an HDMI cable to a TV or monitor. The local management thus made is described in **Section One** of this manual.
2. The other is accessed through the Ethernet connection. The management interface via a web console is identical to the local console. Please refer to the previous discussion for details.

In addition to this, only the Settings page is accessible via the web console. Live view is not available through the Ethernet connection.

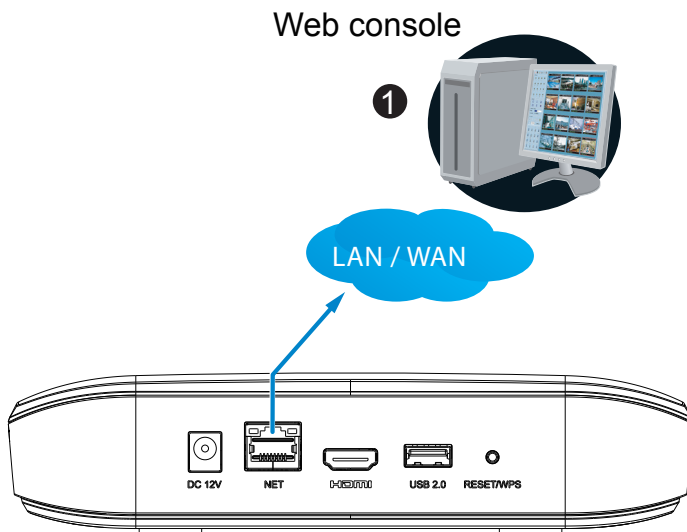

Since the Setting pages are identical, the following pages will be omitted. Please refer to page 33 for the description of the same details in System Settings via a local console.

Some minor differences between the web console and local console exist. One is the Restore Factory default function. It is only available on the web console.

On the chassis, you can press the Restore/WPS button for longer than 10 seconds to restore system defaults.

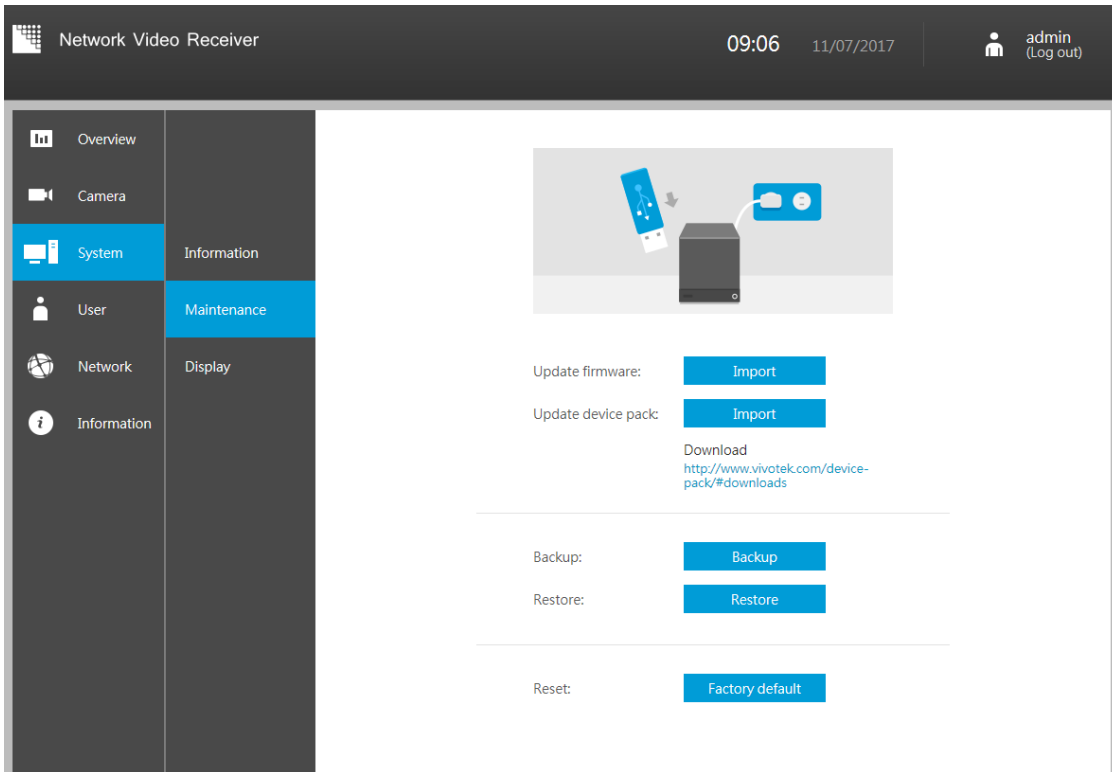

Enter the Information page to change the language used on the configuration interface.

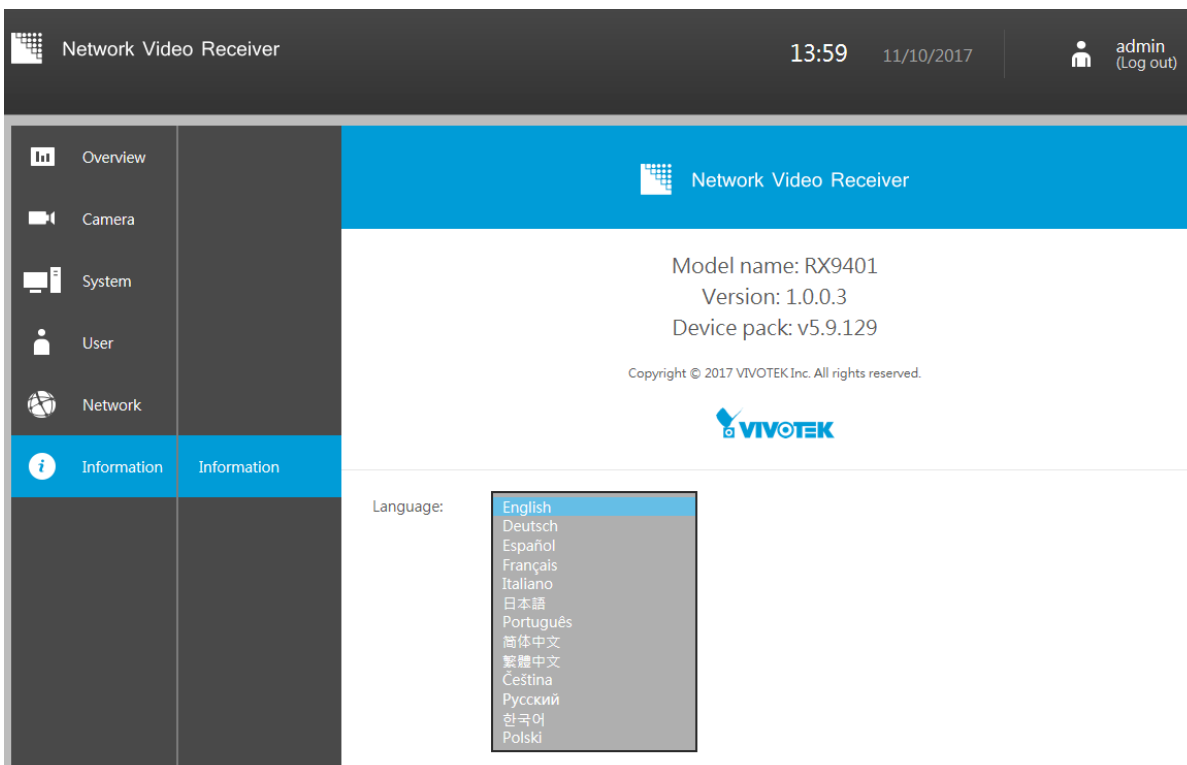

Another difference is the ability to enter a system name using languages other than English. The Receiver's system name also supports the use of other languages. This is only achievable through a web console.

The following characters are not supported:

[>][<][D][{][}]["][%][:][#][&][+][-][\]

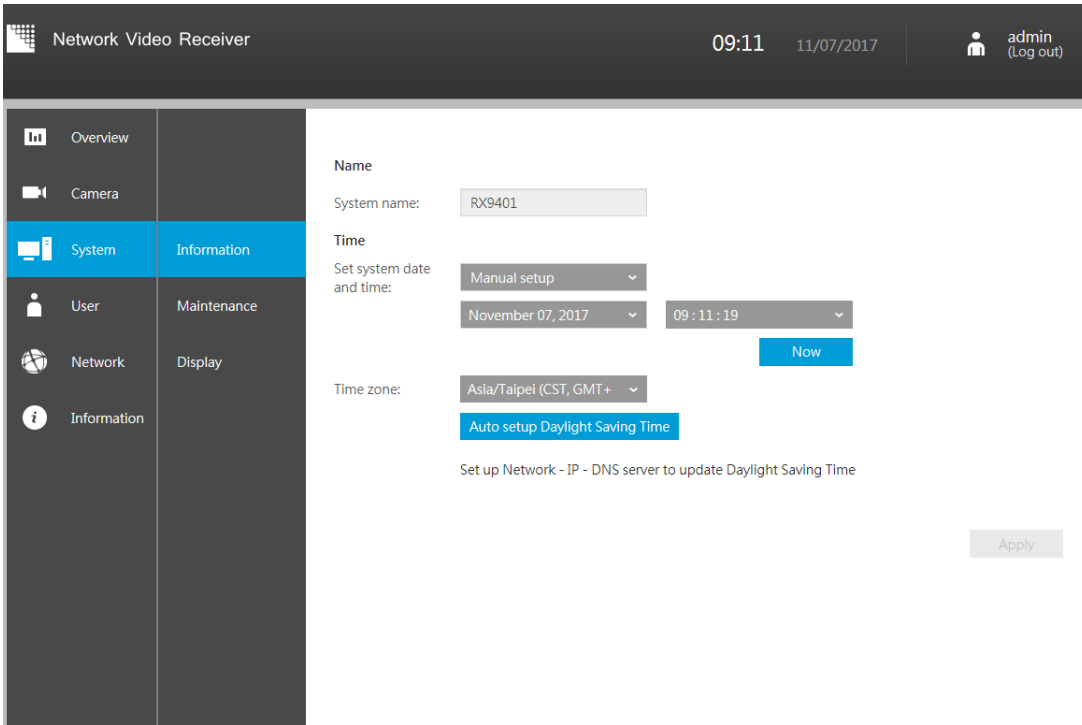

On the System > Display page, you can configure the display layout, and change the output resolution. Note that the output resolution is determined by the capability of your TV or monitor.

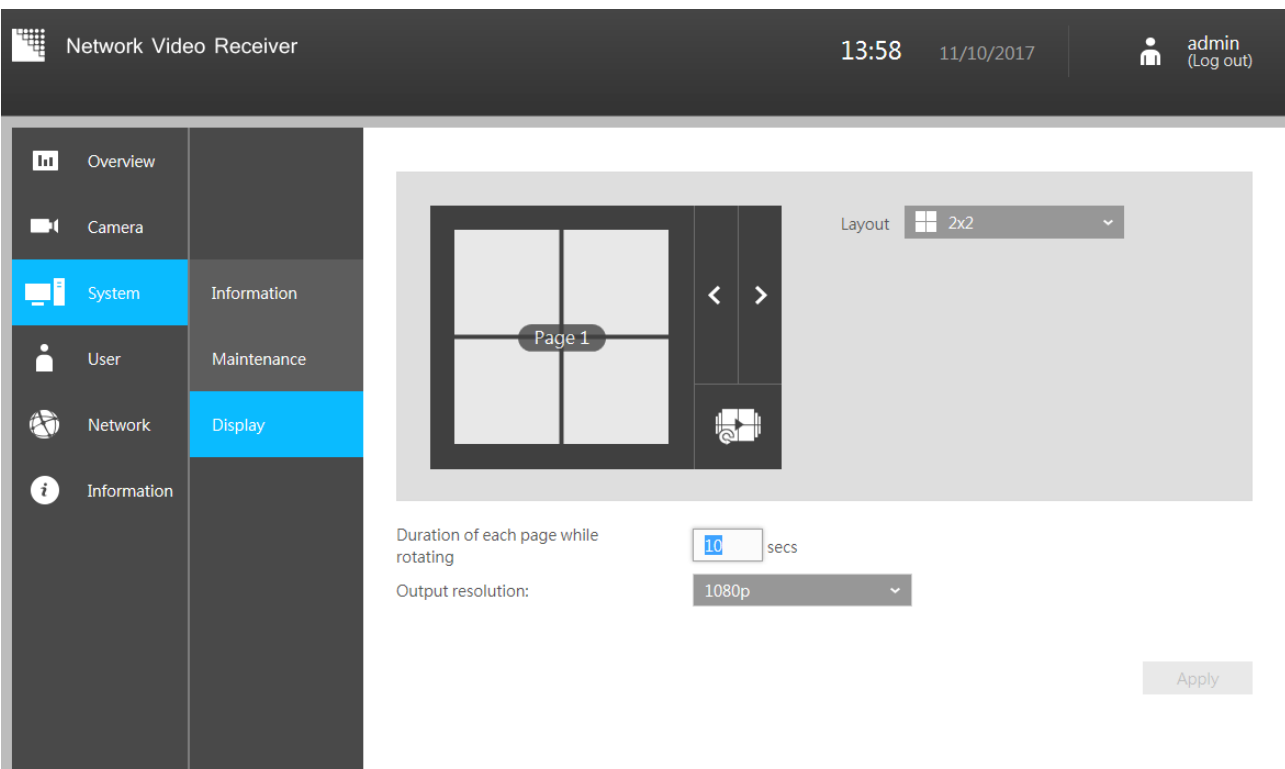

Technical Specifications



Technical Specifications

Hardware Information	
Model	RX9401
System	
OS	Embedded Linux
CPU	ARM Processor
Flash	256 MB
RAM	1GB
Watchdog	Hardware + Software
Power Restoration	System Restart Automatically after Power Recovery
Video & Audio	
Video Output	HDMI x1
Resolution	3840x2160, 1920x1080, 1280x720
Graphics Decoder	Hardware decoding
Decoding Capacity	H.265/H.264: 3840x2160 @ 30 fps (1CH) 1920x1080 @ 120 fps (4CH) 1280x720 @ 270 fps (9CH) 720x480 @ 480 fps (16CH)
Camera Position	Change the viewcell position on the Live View screens
External Interface	
USB Interface	Front: 1 (USB 2.0) Back: 1 (USB 2.0)
Audio	HDMI Audio Output
Network	
Network Interface	10/100Mbps Ethernet (RJ-45) x 1
Protocols	IPv4, TCP/IP, HTTP, HTTPS, UPnP, RTSP/RTP/RTCP, SMTP, DHCP, NTP, DNS, IP Filter
Power	
Power Input	DC 12V 1.5A
Power Consumption	Max. 9.24 W
LED Indicator	
LED Indicator	Power, Status, NET, Camera, Reset
Mechanic	
Form Factor	Mini
Operation Buttons	Reset (Back)
Dimensions	198 (W) x 200 (D) x 47 (H) mm
Weight	530 g
Operating Temperature	0°C ~ 40°C (32°F ~ 104°F)
Humidity	0 ~ 95%

General

Safety Certifications CE, LVD, FCC, VCCI, C-Tick

Warranty 24 months

Client PC Requirements

Operating System Microsoft Windows OS: XP/Vista/7/8/10/2008/2012

CPU Intel Celeron or above

Memory 2 GB or above

Ethernet 10/100Mbps

Display Resolution 1024x768 pixels or above

Web Browser Internet Explorer 10 (32 bit) or above

Software AP Installation Wizard 2, Shepherd

Accessories

Others Power adaptor, QIG, 1 x USB Mouse

Dimensions

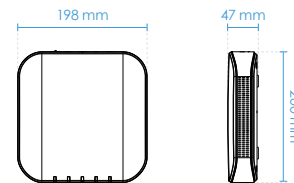

Software Information

LiveView (Local Display)

Stream Application Constant/Auto Adaptive Stream

LiveView Display 16 Channels
Multiple Layout Display:
1x1, 2x2, 3x3, 1P+3, 2P+3, 1M+5, 1P+6, 3V, 1M+12, 4x4

Monitor Enhancement OSD Display (NVR), OSD Display (Camera), Camera Information, Aspect Ratio, Fisheye Dewarp (10, 1P, 1R, 1O3R, 1P3R, 1O8R)

PTZ Control Panel Control/Joystick

PTZ Operation Direction Control, Home, Iris, Preset, Patrol (Group), PIP Control

Backup

Manual USB Dongle (FAT Format)

System

User Management User Account: 16
User Account Time Limit: 10 mins
User Level: Administrator

Date&Time Time Zone, Manual, Automatic Sync NTP, Daylight Saving Time

Technical Specifications

Firmware	Manual upgrade
Restore Default	Supported
Backup/Restore (Configuration)	Supported
Language	Czech, English, French, German, Italian, Japanese, Korean, Portuguese, Russian, Spanish, Simplified Chinese, Traditional Chinese, Polish

Camera Integration

Insert Camera	Manual, Search
ONVIF Core SPEC.	Version 2.2 or above (By Project)

ONVIF Stream	Video (H.264 & MJPEG)
ONVIF Discover	Discover other brand camera through "Insert Camera & Batch Insert"

Device Integration

Joystick	AJ-001, AJ-002
----------	----------------

Safety and Compatibility



Federal Communications Commission (FCC) Statement

This Equipment has been tested and found to comply with the limits for a Class A digital device, pursuant to Part 15 of the FCC rules. These limits are designed to provide reasonable protection against harmful interference when the equipment is operated in a commercial environment. This equipment generates, uses and can radiate radio frequency energy and, if not installed and used in accordance with the instructions, may cause harmful interference to radio communications. Operation of this equipment in a residential area is likely to cause harmful interference in which case the user will be required to correct the interference at his own expense.

Warning:

[A shielded-type power cord is required in order to meet FCC emission limits and also to prevent interference to the nearby radio and television reception. It is essential that only the supplied power cord be used.]

[Use only shielded cables to connect I/O devices to this equipment.]

You are cautioned that changes or modifications not expressly approved by the party responsible for compliance could void your authority to operate the equipment.

[]: depend on EUT condition.



Information on Disposal for Users of Waste Electrical & Electronic Equipment (private households)

This symbol on the products and/or accompanying documents means that used electrical and electronic products should not be mixed with general household waste.

For proper treatment, recovery and recycling, please take these products to designated collection points, where they will be accepted on a free of charge basis. Alternatively, in some countries you may be able to return your products to your local retailer upon the purchase of an equivalent new product.

Disposing of this product correctly will help to save valuable resources and prevent any potential negative effects on human health and the environment which could otherwise arise from inappropriate waste handling. Please contact your local authority for further details of your nearest designated collection point.

Penalties may be applicable for incorrect disposal of this waste, in accordance with national legislation.

For business users in the European Union

If you wish to discard electrical and electronic equipment, please contact your dealer or supplier for further information.

Information on Disposal in other Countries outside the European Union

This symbol is only valid in the European Union. If you wish to discard this product, please contact your local authorities or dealer and ask for the correct method of disposal.

Japan VCCI Class A statement

この装置は、クラス A 情報技術装置です。この装置を家庭環境で使用すると電波妨害を引き起こすことがあります。この場合には使用者が適切な対策を講ずるよう要求されることがあります。 VCCI-A



ACA (Australian Communications Authority)

CAUTION
RISK OF EXPLOSION IF BATTERY IS REPLACED
BY AN INCORRECT TYPE.
DISPOSE OF USED BATTERIES ACCORDING TO THE INSTRUCTIONS