



PRO SERIES

inPulse+

Multi-Biometric Finger Vein & Fingerprint Access Control Reader

inPulse+ is a multi-biometric reader capable of capturing and processing BOTH finger vein pattern & fingerprint biometric data at the same time.



Biometric Performance:

Combines revolutionary SilkID fingerprint sensor and powerful finger vein pattern sensor to achieve the highest degree of accuracy. Identifies users in less than 2 seconds.



Communication:

Weigand output for when connecting to an access control panel and Ethernet port for fast and reliable network communication.



Capacity:

Stores up to 1,000 finger vein and 1,000 fingerprint templates. Data can be backed up to a USB flash drive and transferred to another inPulse+ in the absence of network connectivity.



Options:

Internal Proximity Card or Mifare Card reader allows dual factor authentication for access control.



Easy Operation and Management:

Works without a computer. Complete setup and programming can be done via the "inPulse+ keypad and embedded firmware. Audio-Visual indication for acceptance and rejection of valid/invalid fingerprints, cards and passwords.



Access control:

Relay Outputs for electric lock and alarm. Inputs for door status sensor and request to exit hardware. Supports multiple time zones and personnel groups for programming valid entry zones.



For Software Developers:

Free SDK and development tools are available for developers/partners who wish to integrate inPulse+ with any application which requires verifying people. Custom development is also available for OEM partners upon request.

Configuration

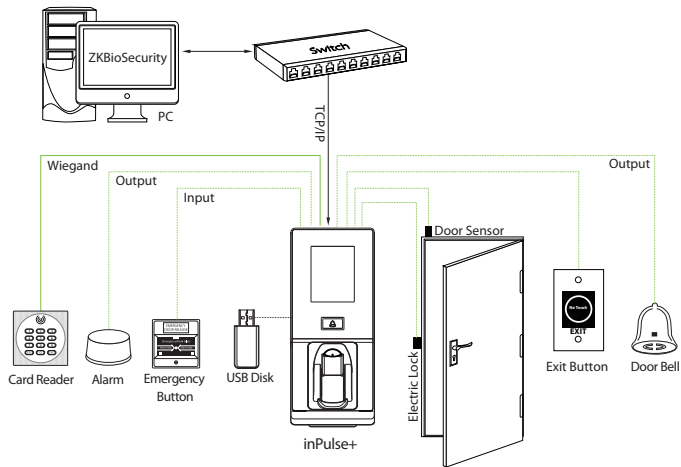

Dimensions

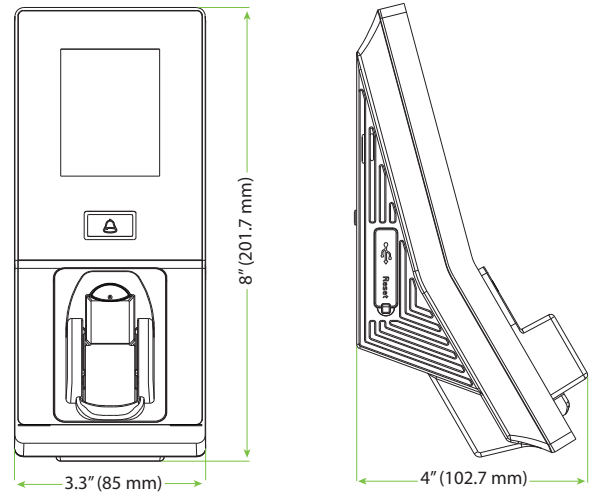

Specifications

Capacity

Finger Veins: 1,500
 Fingerprints: 1,500
 Cards: 2,000

Access Control Interface

Lock Relay Output
 Alarm Output/Auxiliary Input
 Exit Button/Door Sensor
 Doorbell Output

Communication

TCP/IP
 USB Host
 Wiegand Input/Output

Hardware

ZK Fingerprint Sensor
 2.8 Inch TFT-LCD Touch Screen
 125 kHz ZKAccess Card Reader
 Tamper Switch Alarm

Standard Functions

Access Levels/Groups/Holidays
 DST/Bell Schedule
 Duress Mode (Password)
 Anti-Passback
 Record Query
 Custom Wallpaper & Screen Saver

Software Compatibility

ZKBioSecurity

Additional Info

Working Temperature:
 14° F to 122° F (-10° C to 50° C)
 Dimensions: 8 x 3.3 x 4 inches
 Package Includes: 12V 3A Power Supply

Power

Operating Voltage 12V DC
 Current Draw < 500mA

Part Numbers

inPulse+

includes ZKAccess card reader

inPulse+ HID

includes HID 125 kHz card reader

inPulse+ Mifare

includes Mifare card reader

inPulse+ iClass

includes HID iClass card reader

What's in the Box

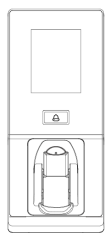

inPulse+



Installation Template

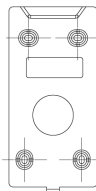

Back Plate

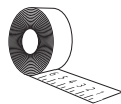

Measuring Tape

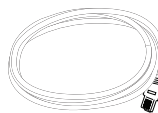

Network Cable



Screws

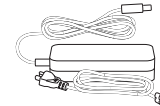

AC Power Adapter

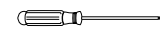

Screwdriver



Cables

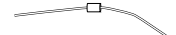

Diode



ZKAccess

6 Kingsbridge Road, Unit 8, Fairfield, NJ 07004
 Phone: (862) 505-2101 • Fax: (862) 204-5906 • sales@zkaccess.com • www.zkaccess.com

© Copyright 2016, ZKTeco Inc. ZKTeco Logo and ZKAccess Logo are registered trademarks of ZKTeco or a related company. All other product and company names mentioned are used for identification purposes only and may be the trademarks of their respective owners. All specifications are subject to change without notice. All rights reserved.

