

rayMAX 50 PoE and rayLUX 50 PoE

High Power PoE illuminators installation guide

This installation guide provides instructions for installing the RAYMAX 50 & RAYLUX 50 High Power PoE series illuminators.

Installation Steps

1. Mount Illuminator
2. Feed cable into connector
3. Connect cable to waterproof connector
4. Connect to high power PoE switch or hub

Set Up Steps

1. Optional night set-up for optimum image performance
2. Adjust vertical angle
3. Tighten all fixings

Package Contents

1. High power PoE illuminator including waterproof connector

Overview

RAYMAX 50 / RAYLUX 50
HP PoE illuminator
(back of illuminator)

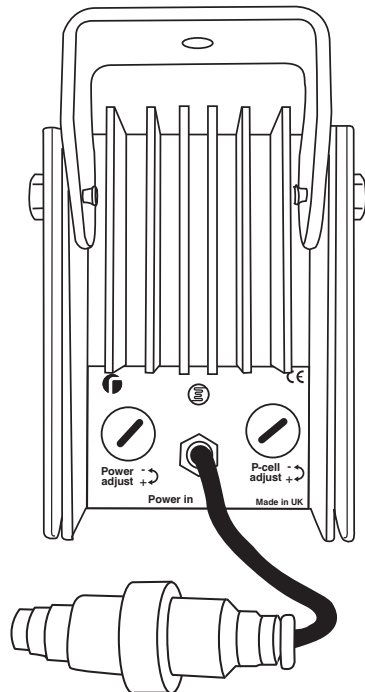

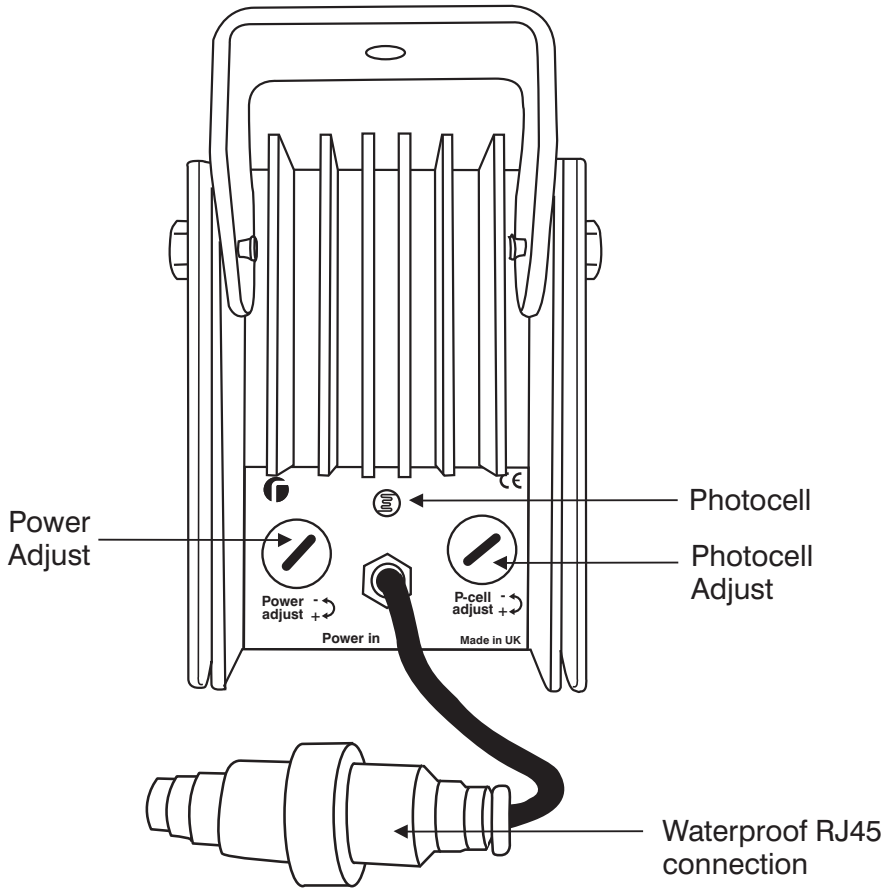



Install in a well ventilated area



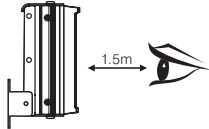

Do not continually stare at lamp

The Raymax and Raylux 50 PoE illuminators use the IEEE802.3af standard detection method and require an injector that can deliver up to 25W.

Specifications subject to change without notice. Installation to be carried out by suitable trained and qualified personnel.

Installation

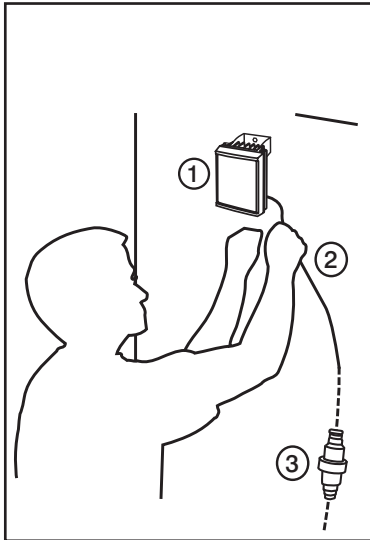

INTERNAL AND EXTERNAL

- ① Mount illuminator
- ② Feed CAT5 cable into waterproof connector
- ③ Unscrew waterproof connector. Feed cable through connector and select the appropriate rubber bung for the outside cable diameter. Terminate cable with an RJ45 connector and fit into the RJ45 socket. Fit the two waterproof connector ends together and tighten. Finally tighten the two end gland nuts to ensure that it is waterproof
- ④ Connect to a 802-3AF protocol standard high power PoE injector switch or hub.

Set Up

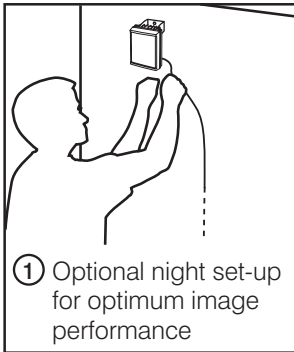

① Optional night set-up for optimum image performance

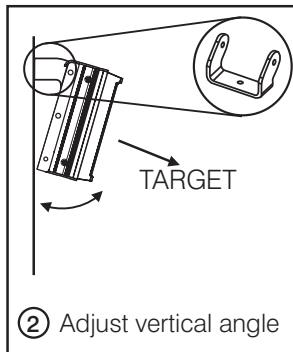

② Adjust vertical angle

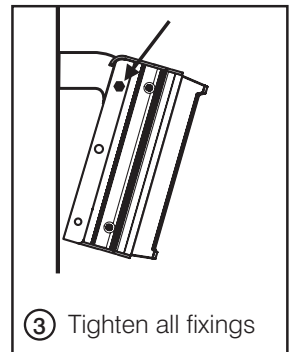

③ Tighten all fixings

Use wall bracket if you require horizontal adjustment.

Match illumination to camera field of view

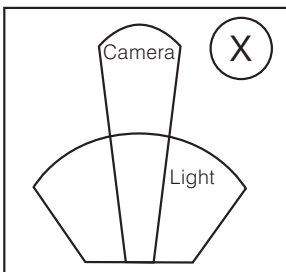

Camera X

Light

Reduces performance

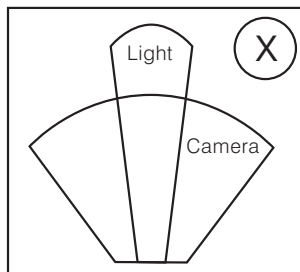

Light X

Camera

May cause hot spots

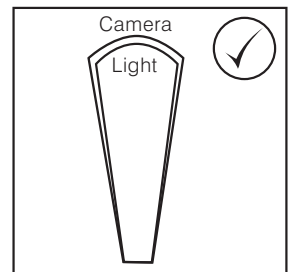

Camera

Light ✓

Best performance

Technical Drawings (Not to scale)

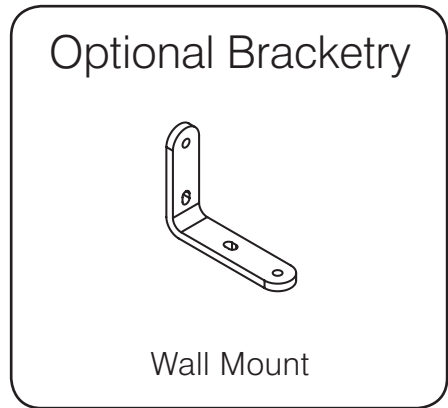
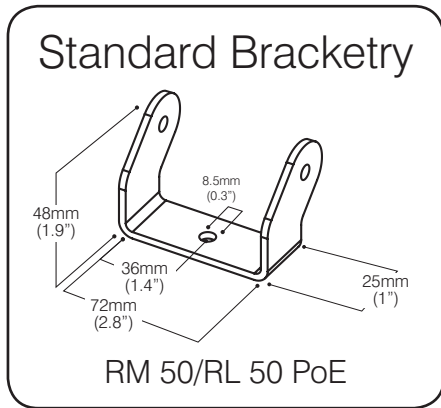

Specifications

INFRA-RED AND WHITE-LIGHT Series

Input	Output	PoE	Photocell	Adjustable Power	Weight	Dimensions L x W x D
PoE	up to 25W	Uses IEEE802.3af standard detection method. CAT5 Cable	Integrated (adjustable sensitivity)	10% - 100%	1kg (2.2lbs)	135 x 100 x 63mm 5.25" x 4" x 2.5" approx

Command and Control Integrated Power Supply Features

- Adjustable photocell
- Adjustable power

Trouble Shooting

Step 1: Basics

- Ensure power adjust is turned to the maximum level for troubleshooting.
- Ensure Photocell operates as required and turns lamp on and off when covered, if necessary adjust the photocell sensitivity.
- When the light is on, a dull red glow should be visible from your Infra-Red illuminator, and a bright white beam should be visible from your White-Light illuminator.
- Confirm that the PoE injector, hub or switch unit is fully functioning and is suitably rated to provide required power and suitably rated to protocol standard 802-3af to provide power.

NB: Refer to manufacturer's guide

- Ensure you have wired RJ45 connectors correctly at both ends.
- Check that the RJ45 waterproof connection is sound and fully weather protected.
- Check that the cable is fully intact, and not broken or split.

Step 2: Set-up Camera, lens and illumination

Check alignment of lamp

Check camera lens – fully open at night & set correctly.

Check model number to Raytec performance specification to ensure required distance is achievable.

Step 3: Call Raytec for further assistance

Note down:

- Model and serial number of illuminator
- Camera make and model
- Lens make and model

If the Raytec lamp is still not delivering the required performance, please contact us for further assistance: tel +44 (0) 1670 520055.



rayTEC[®]

UK / Europe

T: +44 (0) 1670 520055

F: +44 (0) 1670 819760

sales@raytecctv.com

Americas (Toll Free)

T: +1 888 505 8335

ussales@raytecctv.com

www.raytecctv.com