

3-Port Single Gang Stainless Steel Faceplate

PRODUCT SPECIFICATION

Package includes:

- A. 3-Port Single Gang Stainless Steel Faceplate, 1 pc
- B. Retaining Bracket, 1 pc
- C. Brass Eyelet, 2 pcs
- D. #6-32 x 3/4" Oval Head, Countersink Machine Screw, 2 pcs

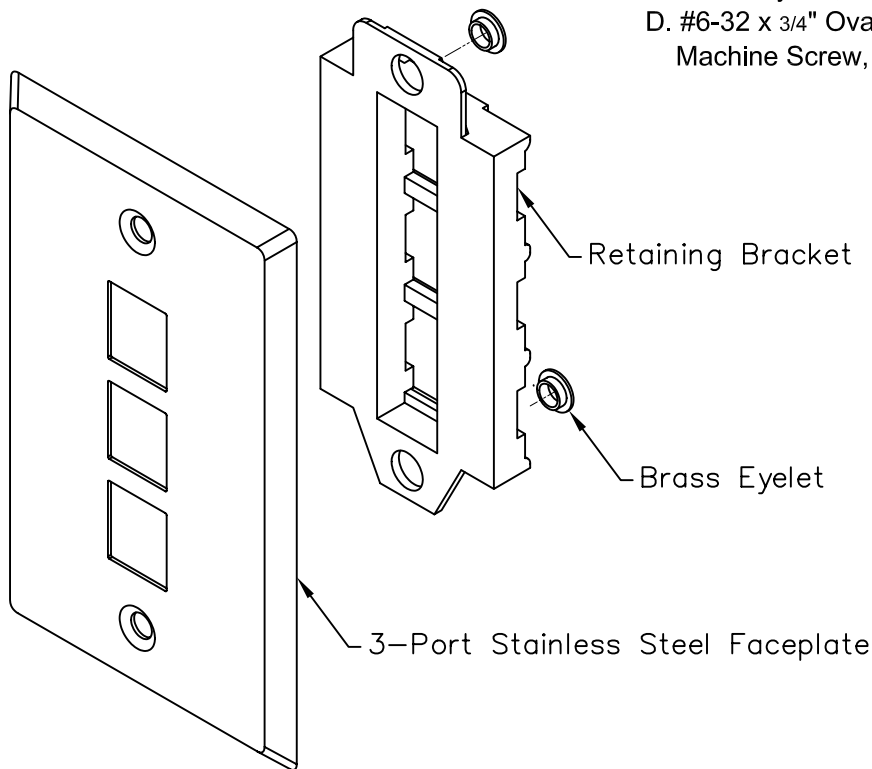

Features and Benefits:

- Configured to fit standard single gang outlet box
- Designed to support the distribution of voice, data, and other communication needs to the work area for commercial or residential applications
- Offers a flush face surface
- Accommodates a wide variety of easy to snap-in modules, providing configuration flexibility
- Accepts all IC107 modules
- UL listed

FACEPLATE, STAINLESS STEEL, 1-GANG, 3-PORT

ITEM NO.	IC107SF3SS	REV.	B
DWG NO.	PS107SF3SS	PAGE NO.	1



CUSTOMER CARE / TECHNICAL SUPPORT * CSR@ICC.COM / 888-ASK-4-ICC (275-4422) * 14700 Alondra Blvd., La Mirada, CA 90638 * www.icc.com

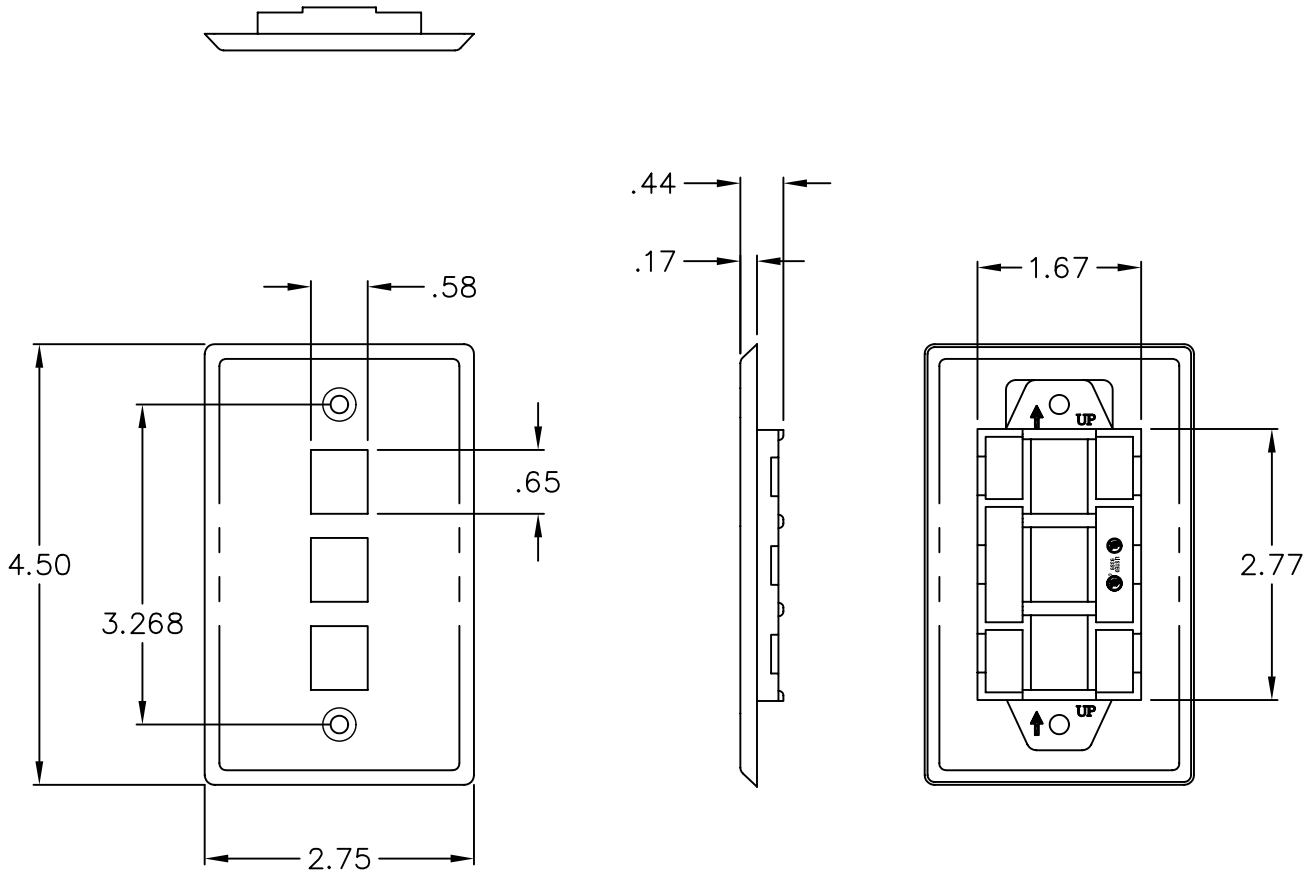

NOTE: UNLESS OTHERWISE SPECIFIED

1. MATERIAL:

- A. FACEPLATE: 22 GA STAINLESS STEEL
- B. RETAINING BRACKET: ABS, UL 94V-0

UL US FILE NO. 125268

FACEPLATE, STAINLESS STEEL, 1-GANG, 3-PORT

ITEM NO.	IC107SF3SS	REV.	B
DWG NO.	PS107SF3SS	PAGE NO.	2



CUSTOMER CARE / TECHNICAL SUPPORT * CSR@ICC.COM / 888-ASK-4-ICC (275-4422) * 14700 Alondra Blvd., La Mirada, CA 90638 * www.icc.com