

8-Port Double Gang Faceplate With Station ID

PRODUCT SPECIFICATION

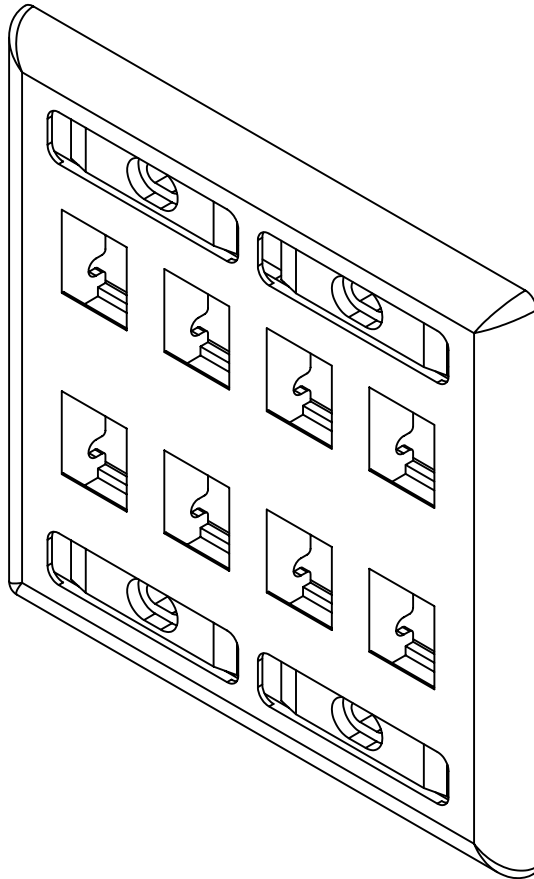

Package includes:

- A. 8-Port Double Gang Faceplate With Station ID, 1 pc
- B. ICC Label Cover, 2 pcs
- C. Clear Label Cover, 4 pcs
- D. Paper Label, 4 pcs
- E. #6-32 x 3/4" Pan Head Machine Screw, 4 pcs

8-Port Faceplate With Station ID



ICC Label Cover

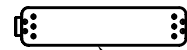

Clear Label Cover

Features and Benefits:

- Configured to fit standard double gang outlet box
- Designed to support the distribution of voice, data, and other communication needs to the work area for commercial or residential applications
- Rugged and durable construction
- Easy station identification with use of enclosed labels protected by clear plastic covers
- Hidden mounting screws
- Accommodates a wide variety of easy to snap-in modules, providing configuration flexibility
- Accepts all IC107 modules
- Available in ivory and white
- UL listed

FACEPLATE, ID, 2-GANG, 8-PORT

ITEM NO. IC107SD8XX

REV. A

DWG NO. PS107SD800

PAGE NO. 1



CUSTOMER CARE / TECHNICAL SUPPORT * CSR@ICC.COM / 888-ASK-4-ICC (275-4422) * 14700 Alondra Blvd., La Mirada, CA 90638 * www.icc.com

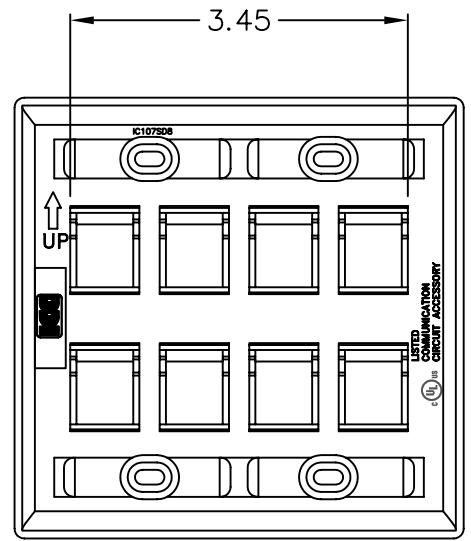
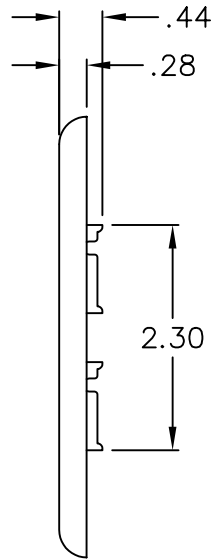
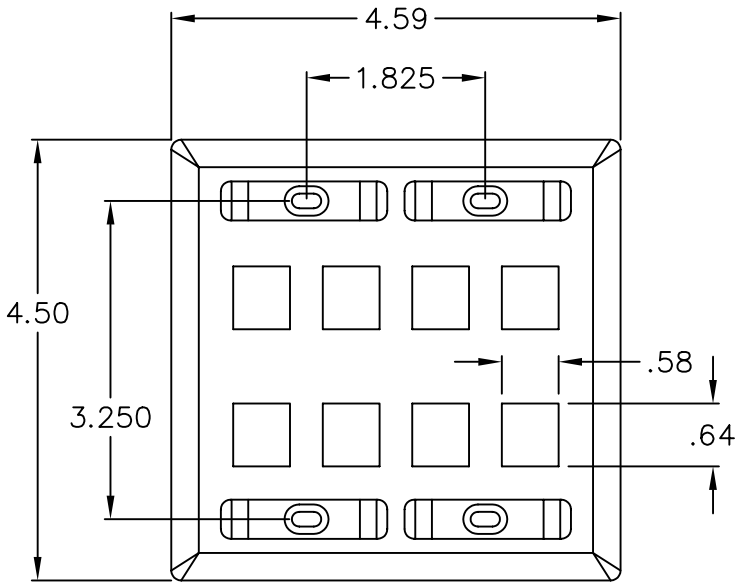
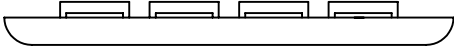

NOTE: UNLESS OTHERWISE SPECIFIED

1. MATERIAL: ABS, UL 94V-0
2. FINISH: TEXTURE
3. COLOR: XX: IV-IVORY & WH-WHITE

UL US FILE NO. 125268

FACEPLATE, ID, 2-GANG, 8-PORT		 <i>PremiumProducts</i> <i>ProvenPerformance</i> <i>CompetitivePrices</i>	
ITEM NO.	IC107SD8XX		REV. A
DWG NO.	PS107SD800		PAGE NO. 2

CUSTOMER CARE / TECHNICAL SUPPORT * CSR@ICC.COM / 888-ASK-4-ICC (275-4422) * 14700 Alondra Blvd., La Mirada, CA 90638 * www.icc.com