

3-Port Decorex Insert

PRODUCT SPECIFICATION

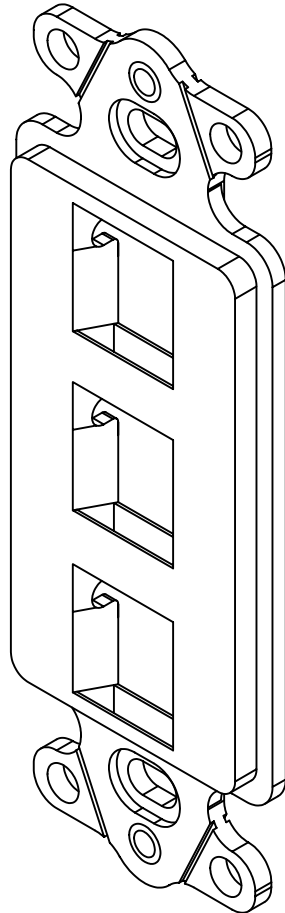

Package includes:

- A. 3-Port Decorex Insert, 1 pc
- B. #6-32 x 3/4" Pan Head Machine Screw, 2 pcs

3-Port Decorex Insert

Features and Benefits:

- Designed to support the distribution of voice, data, and other communication needs with contemporary styling for commercial or residential applications
- Fits standard NEMA electrical boxes
- Designed for a consistent look with standard decorator style faceplates
- Compatible with all IC107 Decorex faceplates
- Accommodates a wide variety of easy to snap-in modules, providing configuration flexibility
- Accepts all IC107 modules
- Available in almond, black, ivory, and white
- UL listed

INSERT, DECOREX, 3-PORT

ITEM NO.	IC107DI3XX
DWG NO.	PS107DI300

REV.	A
PAGE NO.	1



CUSTOMER CARE / TECHNICAL SUPPORT * CSR@ICC.COM / 888-ASK-4-ICC (275-4422) * 14700 Alondra Blvd., La Mirada, CA 90638 * www.icc.com

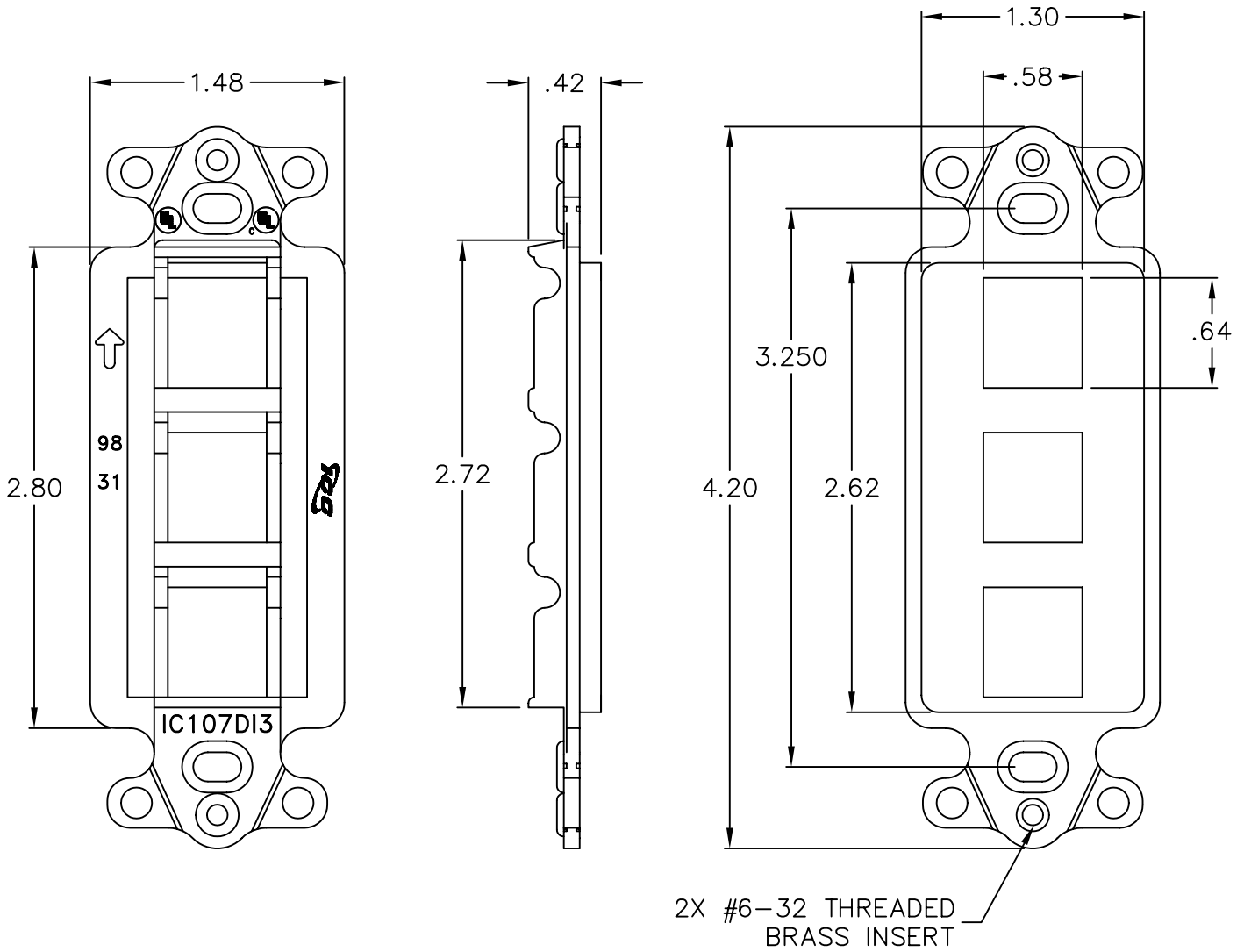

NOTE: UNLESS OTHERWISE SPECIFIED

1. MATERIAL: ABS, UL 94V-0
2. FINISH: GLOSSY
3. COLOR: XX: AL-ALMOND, BK-BLACK, IV-IVORY & WH-WHITE

UL US FILE NO. 125268

INSERT, DECOREX, 3-PORT		 PremiumProducts <i>ProvenPerformance</i> <i>CompetitivePrices</i>	
ITEM NO.	IC107DI3XX		REV. A
DWG NO.	PS107DI300		PAGE NO. 2

CUSTOMER CARE / TECHNICAL SUPPORT * CSR@ICC.COM / 888-ASK-4-ICC (275-4422) * 14700 Alondra Blvd., La Mirada, CA 90638 * www.icc.com