

RGB with 2-Port Decorex Insert

PRODUCT SPECIFICATION

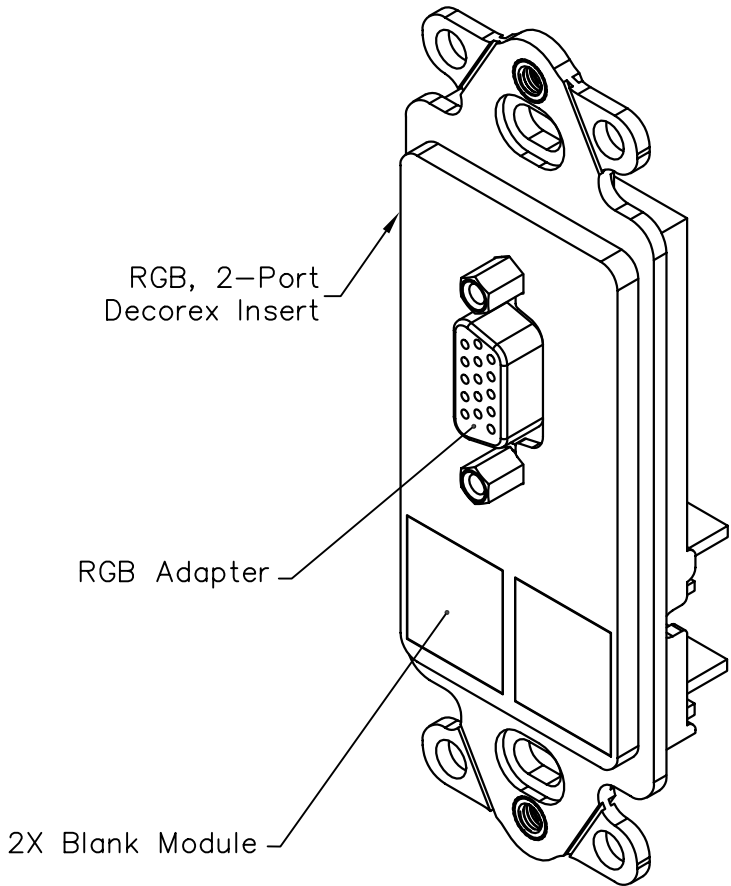

Package includes:

- A. RGB, 2-Port Decorex Insert, 1 pc
- B. Blank Module, 2 pcs

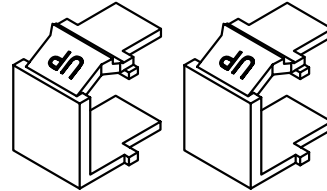

- C. #6-32 x 3/4" Pan Head Machine Screw, 2 pcs

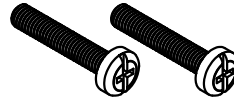

Features and Benefits:

- Designed to support the distribution of video, voice, data, and other communication needs with contemporary styling for commercial or residential applications
- RGB Connector is ideal for the transmission of high quality video
- Fits standard NEMA electrical boxes
- Rugged and durable construction
- Designed for a consistent look with standard decorator style faceplates
- Compatible with all IC107 Decorex faceplates
- Accommodates a wide variety of easy to snap-in modules, providing configuration flexibility
- Compatible with all IC107 HD modules
- Available in almond, black, ivory, and white

INSERT, DECOREX, RGB, 2-PORT		 <i>PremiumProducts</i> <i>ProvenPerformance</i> <i>CompetitivePrices</i>	
ITEM NO.	IC107DR2XX		REV. C
DWG NO.	PS107DR200		PAGE NO. 1

CUSTOMER CARE / TECHNICAL SUPPORT * CSR@ICC.COM / 888-ASK-4-ICC (275-4422) * 14700 Alondra Blvd., La Mirada, CA 90638 * www.icc.com

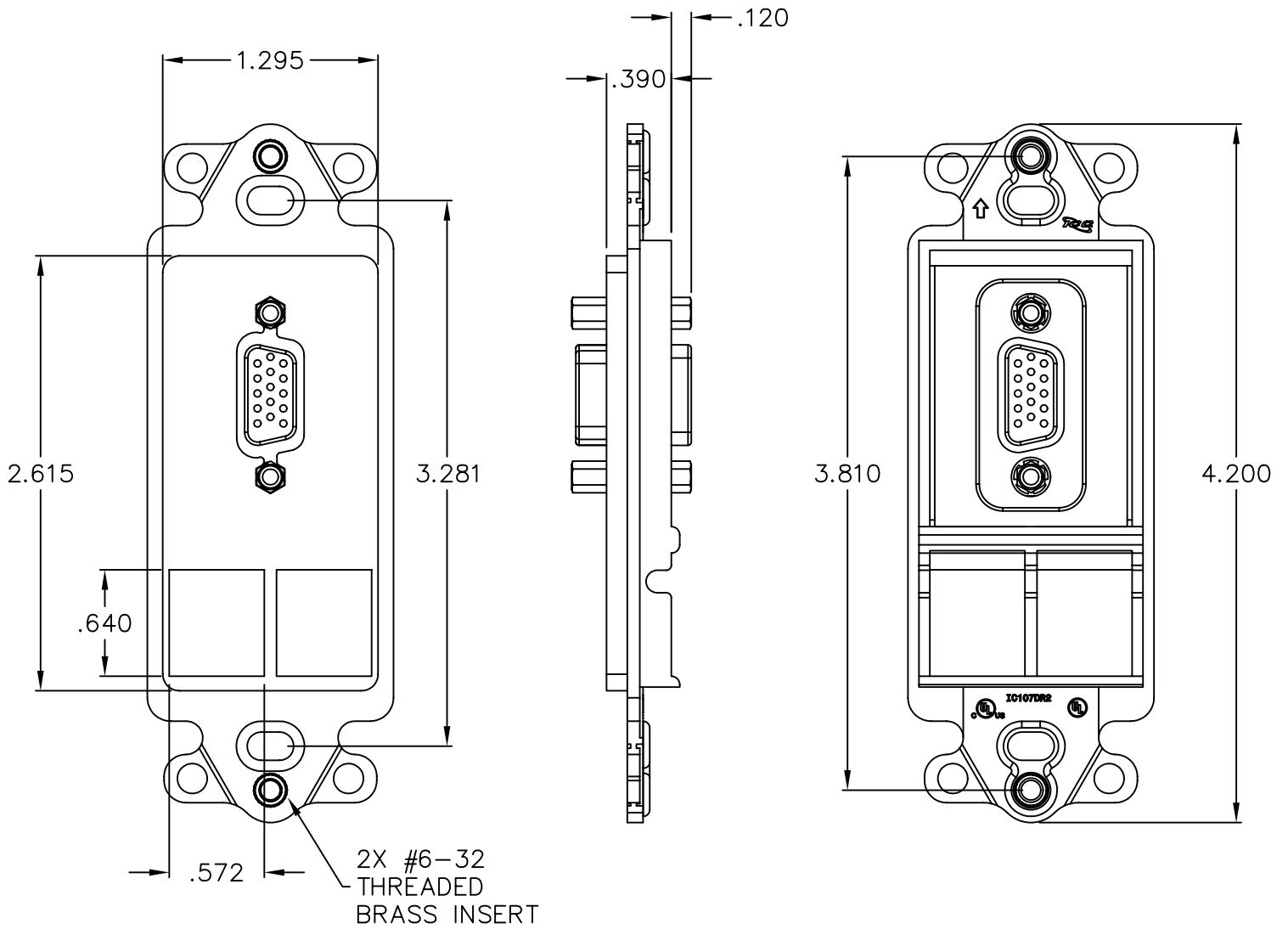

NOTE: UNLESS OTHERWISE SPECIFIED

1. MATERIAL: ABS, UL 94V-0
2. COLOR: XX: AL-ALMOND, BK-BLACK, IV-IVORY & WH-WHITE
3. MECHANICAL:
 - A. SHELL: ZINC PLATED STEEL
 - B. PIN CONTACT: PHOSPOR BRONZE
 - C. INSULATOR: PBT & GLASS-FIBRE REINFORCED UL 94-V0
 - D. NUMBER OF CONTACTS: 15
4. ELECTRICAL:
 - A. CURRENT RATING: 5 AMP
 - B. DIELECTRIC STRENGTH: 1000V FOR ONE MINUTE
 - C. INSULATOR RESISTANCE: 1000M OHM MIN. @ 500V DC
 - D. TEMPERATURE: -55°C TO +105°C

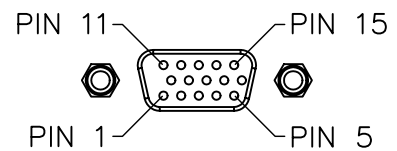

FRONT VIEW

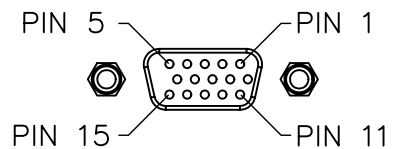

REAR VIEW

INSERT, DECOREX, RGB, 2-PORT		 PremiumProducts ProvenPerformance CompetitivePrices	
ITEM NO.	IC107DR2XX		REV. C
DWG NO.	PS107DR200		PAGE NO. 2

CUSTOMER CARE / TECHNICAL SUPPORT * CSR@ICC.COM / 888-ASK-4-ICC (275-4422) * 14700 Alondra Blvd., La Mirada, CA 90638 * www.icc.com