

4-Port Elite Surface Mount Box

PRODUCT SPECIFICATION

Package includes:

- A. Elite Surface Mount Box Cover, 1 pc
- B. Elite Surface Mount Box Base, 1 pc
- C.  Icon, 4 pcs
- D. Double Sided Adhesive Strip, 2 pcs
- E. 4" Cable Tie, 3 pcs
- F. #6 x 3/4" Pan Head, Sharp Point Tapping Screw, 2 pcs

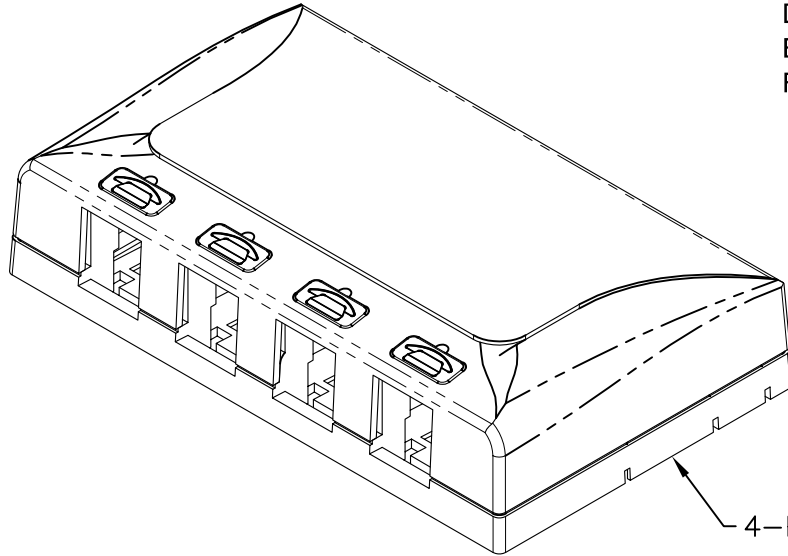

4-Port Elite Surface Mount Box

Features and Benefits:

- Provides a clean modular surface mount outlet solution of voice, data, and other communication needs to the work area for commercial or residential applications
- Multiple mounting options including adhesive backings, screws, and magnets
- Rugged and durable construction
- Easy system administration with use of enclosed icons
- Raceway knockouts integrate with raceway systems
- Used with ICRW11 and ICRW12 raceway systems
- Accommodates a wide variety of easy to snap-in modules, providing configuration flexibility
- Accepts all IC107 modules
- Available in gray, ivory, and white
- UL listed

SURFACE MOUNT BOX, ELITE, 4-PORT			
ITEM NO.	IC108SB4XX	REV.	B
DWG NO.	PS108SB400	PAGE NO.	1
		<i>PremiumProducts</i> <i>ProvenPerformance</i> <i>CompetitivePrices</i>	

CUSTOMER CARE / TECHNICAL SUPPORT * CSR@ICC.COM / 888-ASK-4-ICC (275-4422) * 14700 Alondra Blvd., La Mirada, CA 90638 * www.icc.com

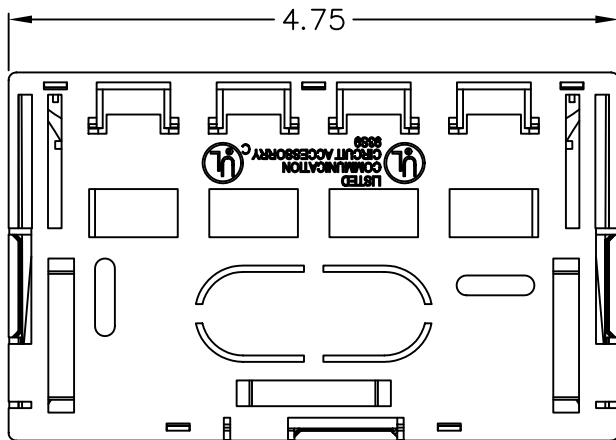
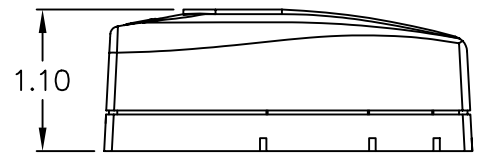
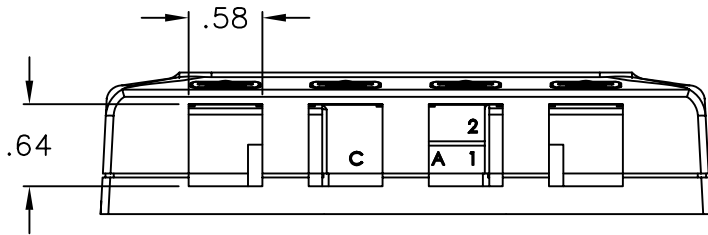
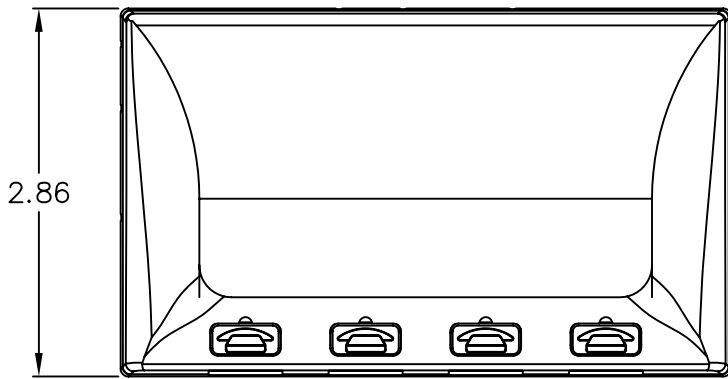

NOTE: UNLESS OTHERWISE SPECIFIED

1. MATERIAL: ABS, UL 94V-0
2. COLOR: XX: GY-GRAY, IV-IVORY, & WH-WHITE
3. KNOCKOUT DIMENSIONS: .80"X.55" & 1.30"X.85"

UL US FILE NO. 125268

SURFACE MOUNT BOX, ELITE, 4-PORT		 <i>PremiumProducts</i> <i>ProvenPerformance</i> <i>CompetitivePrices</i>
ITEM NO.	IC108SB4XX	
DWG NO.	PS108SB400	PAGE NO. 2

CUSTOMER CARE / TECHNICAL SUPPORT * CSR@ICC.COM / 888-ASK-4-ICC (275-4422) * 14700 Alondra Blvd., La Mirada, CA 90638 * www.icc.com