

24-Slot Front Finger Duct Panel, 2 RMS

PRODUCT SPECIFICATION

Package includes:

- A. 2 RMS 24-Slot Front Finger Duct Panel, 1 pc
- B. 2 RMS Finger Duct Panel Cover, 1 pc
- C. #12-24 x 5/8" Pan Head, Pilot Point Machine Screw, 4 pcs

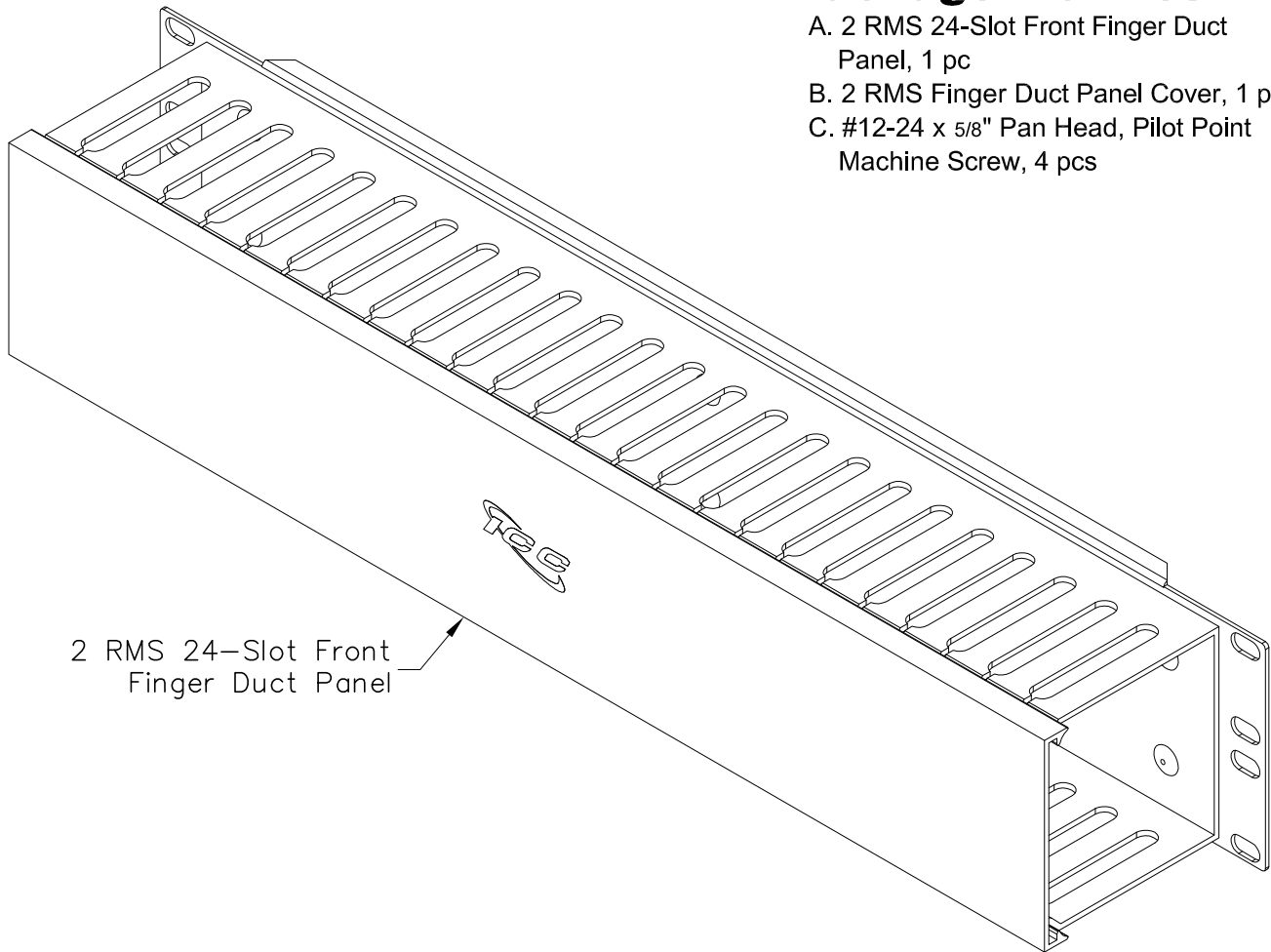

2 RMS 24-Slot Front Finger Duct Panel

Features and Benefits:

- Provides flexibility for front cable management with a neat and clean appearance
- Designed with slotted ducts providing horizontal cable management on the front of a rack
- Designed to fit all standard 19" racks and cabinets
- 2 rack mount space (RMS)
- Used with all ICCMS racks and brackets
- UL listed

PANEL, FRONT FINGER DUCT, 24-SLOT, 2 RMS

ITEM NO.	ICCMSCMA42
DWG NO.	PSCMSCMA42

REV.	E
PAGE NO.	1



CUSTOMER CARE / TECHNICAL SUPPORT * CSR@ICC.COM / 888-ASK-4-ICC (275-4422) * 14700 Alondra Blvd., La Mirada, CA 90638 * www.icc.com

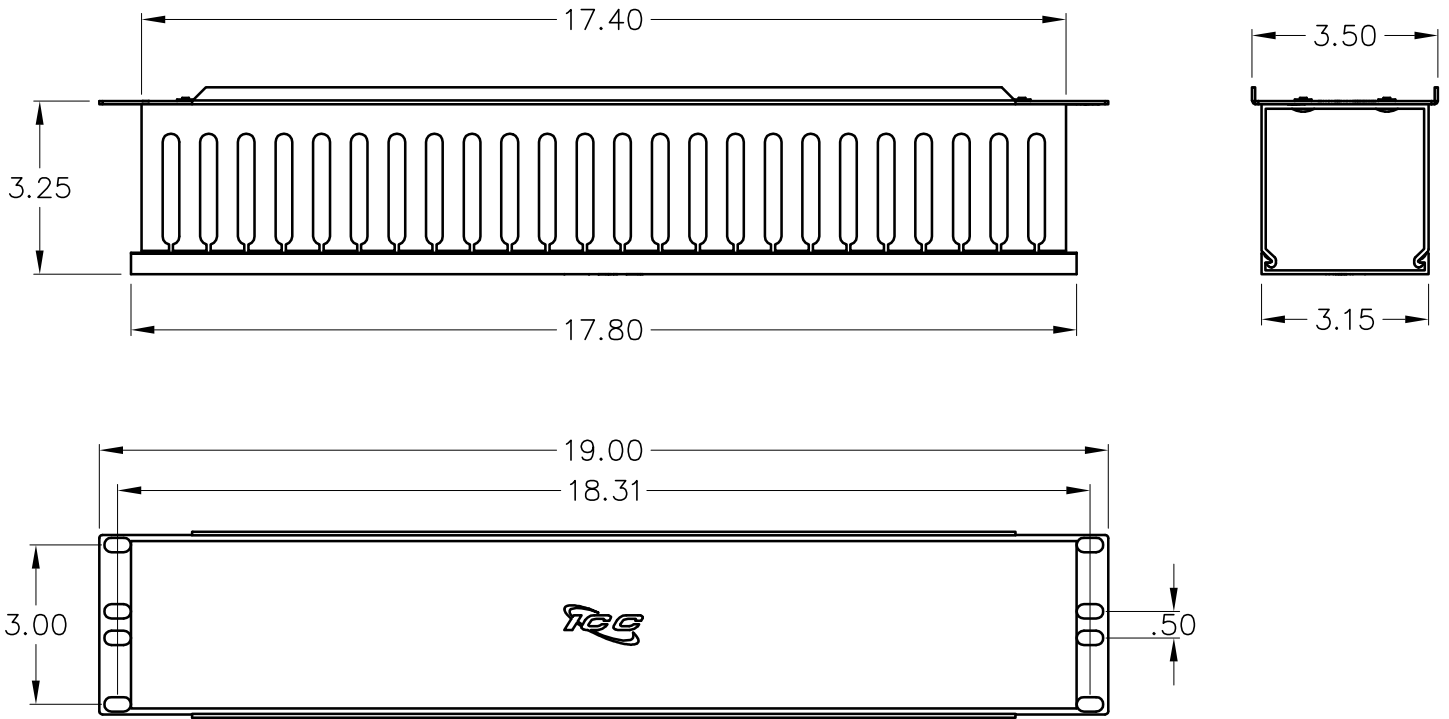

NOTE: UNLESS OTHERWISE SPECIFIED

- 1. PANEL:
 - A. MATERIAL: 16 GA CRS
 - B. SURFACE FINISH: BLACK POWDER COAT
- 2. DUCT:
 - A. MATERIAL: PVC, UL 94V-0
 - B. FINISH: TEXTURE, BLACK
- 3. COVER:
 - A. MATERIAL: PVC, UL 94V-0
 - B. COLOR: BLACK

UL US FILE NO. 125268

PANEL, FRONT FINGER DUCT, 24-SLOT, 2 RMS		 Premium Products Proven Performance Competitive Prices
ITEM NO.	ICCMSCMA42	
DWG NO.	PSCMSCMA42	PAGE NO. 2

CUSTOMER CARE / TECHNICAL SUPPORT * CSR@ICC.COM / 888-ASK-4-ICC (275-4422) * 14700 Alondra Blvd., La Mirada, CA 90638 * www.icc.com