

9" Plastic Net Media Center Combo

PRODUCT SPECIFICATION

Package includes:

- A. 9" Plastic Net Media Center Box, 1 pc
- B. Compact Module, CAT 6, Data, 8-Port, 1 pc
- C. Compact Module, Telephone, 8-Port w/RJ31, 1pc
- D. Resi module, 2 GHz Video Splitter, 1x6, 1 pc
- E. Wiring Location Sheet, 1pc

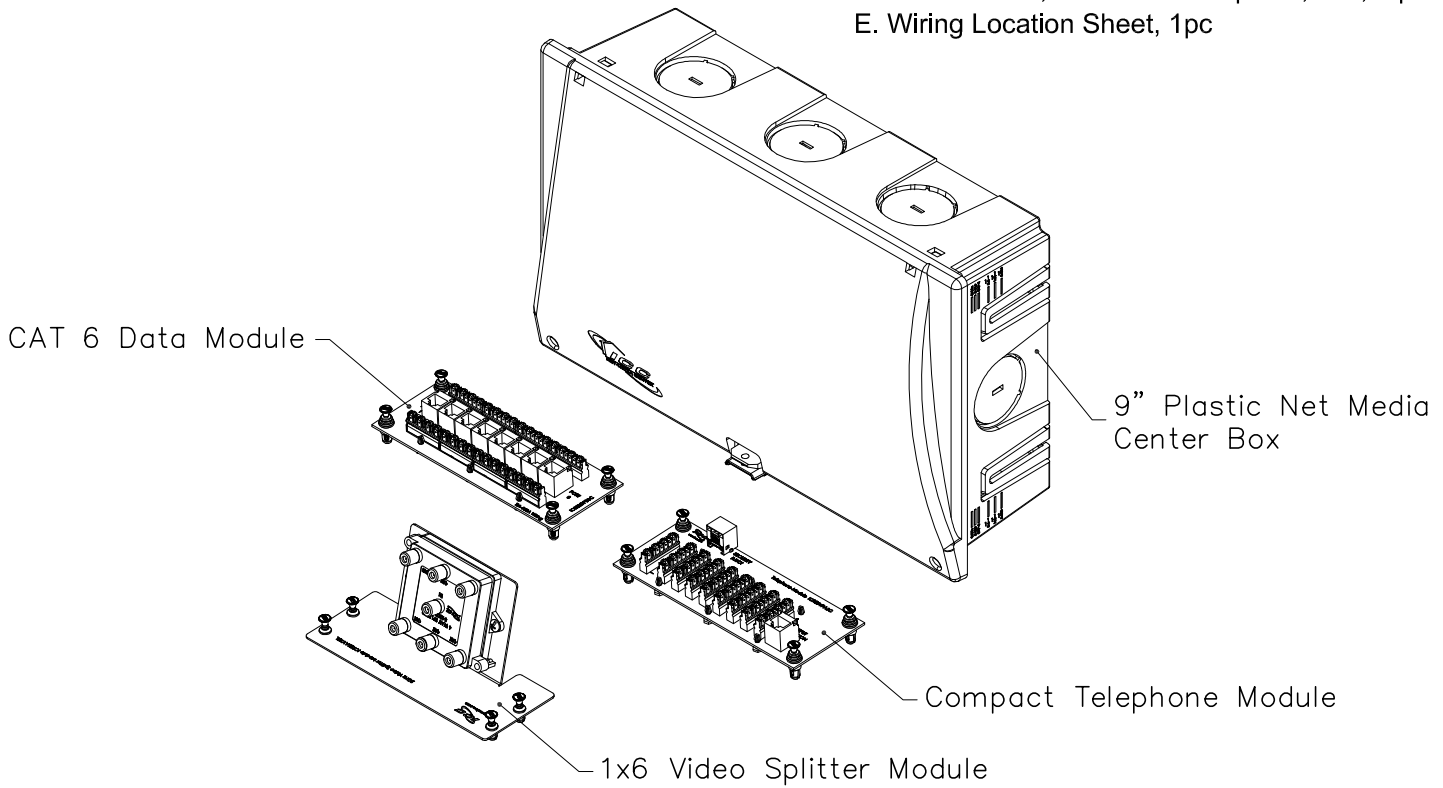

Features and Benefits:

- Designed with high quality, lightweight plastic.
- Designed to serve as the central distribution point for voice, data, video, audio, and security services for smaller residential structured wiring systems.
- Allows for internal modules to be mounted horizontally or vertically.
- Integrated snap-in module system enables users to quickly insert or move the internal modules.
- Includes 3 top, 3 bottom, 4 rear, and 2 side knockouts for routing cables.
- Includes a knockout for an optional AC power outlet (not included) to provide power distribution.
- Fits between 16" wall mounting spaces or can be wall mounted.
- Designed with a pad lock option for additional security (pad lock not included).

COMBO, NET MEDIA CENTER, PLASTIC, 9"

ITEM NO.	ICRESDC9PK
DWG NO.	PSRESDC9PK

REV.	B
PAGE NO.	1



CUSTOMER CARE / TECHNICAL SUPPORT * CSR@ICC.COM / 888-ASK-4-ICC (275-4422) * 14700 Alondra Blvd., La Mirada, CA 90638 * www.icc.com

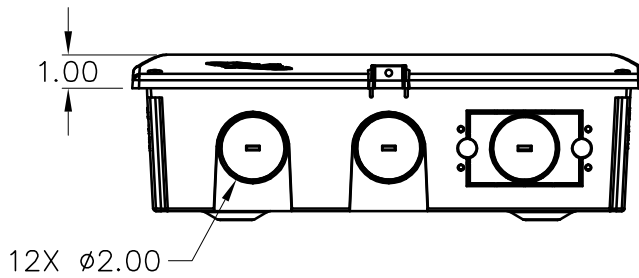
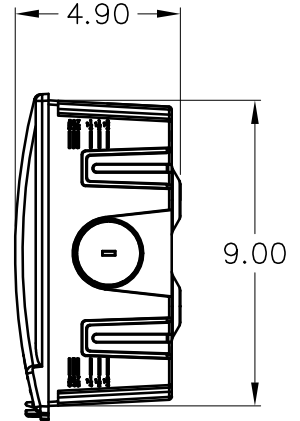
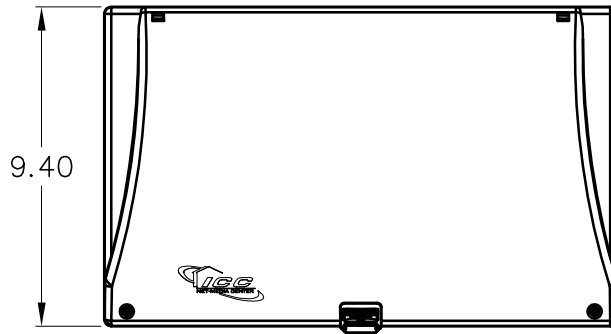
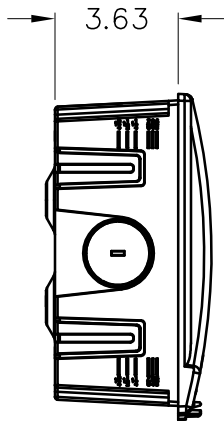
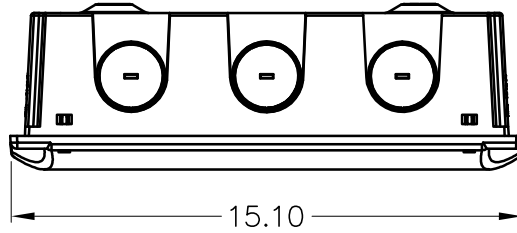
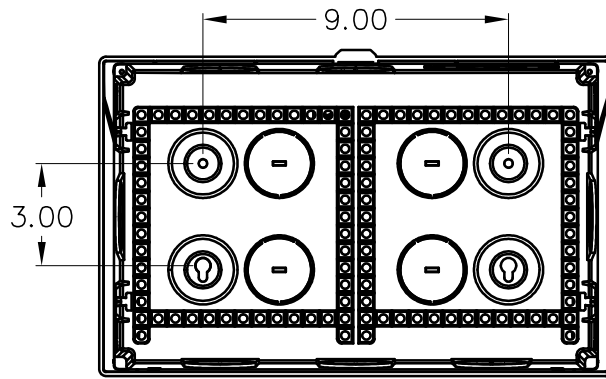

NOTE: UNLESS OTHERWISE SPECIFIED

- 1. MATERIAL: ABS UL 94V-0
- 2. COLOR: WHITE
- 3. FINISH: MATTE

COMBO, NET MEDIA CENTER, PLASTIC, 9'		 <i>Premium Products</i> <i>Proven Performance</i> <i>Competitive Prices</i>	
ITEM NO.	ICRESDC9PK		REV. B
DWG NO.	PSRESDC9PK	PAGE NO.	2

CUSTOMER CARE / TECHNICAL SUPPORT * CSR@ICC.COM / 888-ASK-4-ICC (275-4422) * 14700 Alondra Blvd., La Mirada, CA 90638 * www.icc.com

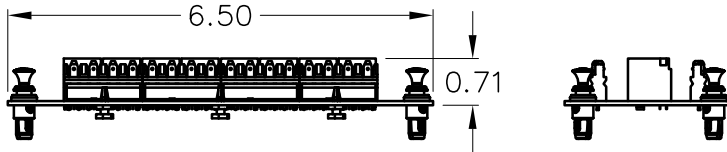
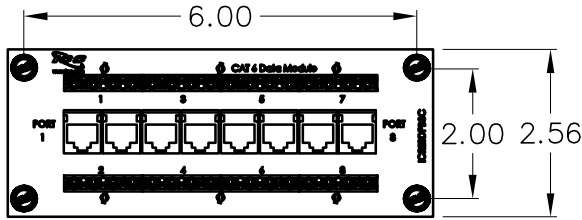

NOTE: UNLESS OTHERWISE SPECIFIED

1. 8-PORT CAT 6 DATA MODULE:
 - A. PCB: GLASS EPOXY FR-4 COPPER CLAD, t=1.20mm
 - B. 110 BLOCK:
 - HOUSING: PC, UL 94V-0
 - IDC: PHOSPHOROUS BRONZE, TIN PLATED
 - C. RJ45 JACK/SOCKET:
 - HOUSING: PBT + 15% FIBER GLASS
 - CONTACT: PHOSPHOROUS BRONZE, 50u" GOLD PLATED
 - D. WIRING IN ACCORDANCE TO T568A
 - E. CATEGORY 6 RATED
2. LOCKING BUTTON: MATERIAL: NYLON 6/6, UL 94V-0

NOTE: UNLESS OTHERWISE SPECIFIED

1. 8-PORT TELEPHONE MODULE WITH RJ31X JACK:
 - A. PCB: GLASS EPOXY FR-4 COPPER CLAD, t=1.20mm
 - B. 110 BLOCK:
 - HOUSING: PC, UL 94V-0
 - IDC: PHOSPHOROUS BRONZE, TIN PLATED
 - C. RJ45 & RJ31X JACK/SOCKET:
 - HOUSING: PBT + 15% FIBER GLASS
 - CONTACT: PHOSPHOROUS BRONZE, 50u" GOLD PLATED
 - D. WIRING IN ACCORDANCE TO T568A
2. LOCKING BUTTON: MATERIAL: NYLON 6/6, UL 94V-0

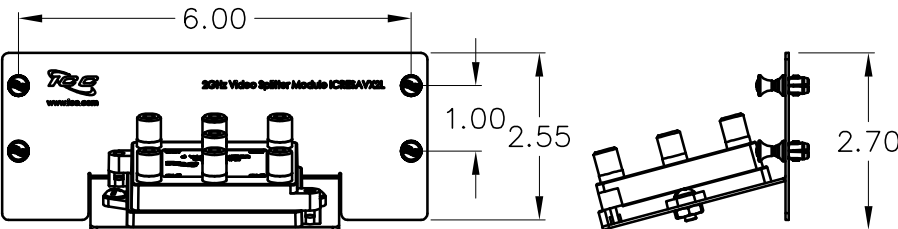
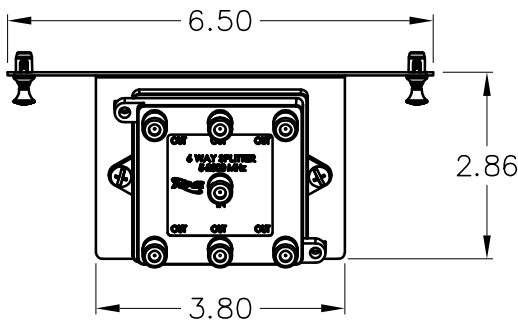
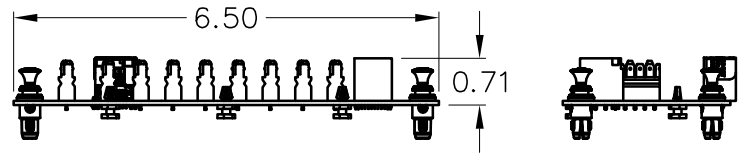
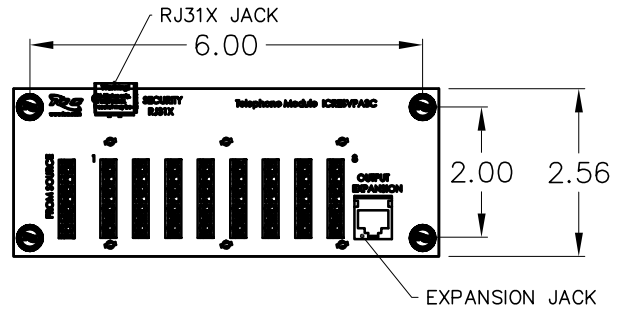

NOTE: UNLESS OTHERWISE SPECIFIED

1. 1X6 VIDEO SPLITTER:
 - A. HOUSING: DIE-CASTING WITH NICKEL PLATING
 - B. CONNECTORS: F-TYPE FEMALE
 - C. FREQUENCY RANGE: 5 ~ 2300 MHZ
 - D. INSERTION LOSS: 15 dB TYPICAL
2. MOUNTING BRACKET:
 - A. MATERIAL: 18 GA CRS
 - B. SURFACE FINISH: WHITE POWDER COAT
3. LOCKING BUTTON: MATERIAL: NYLON 6/6, UL 94V-0

COMBO, NET MEDIA CENTER, PLASTIC, 9'		 Premium Products Proven Performance Competitive Prices	
ITEM NO.	ICRESDC9PK		REV. B
DWG NO.	PSRESDC9PK	PAGE NO.	3

CUSTOMER CARE / TECHNICAL SUPPORT * CSR@ICC.COM / 888-ASK-4-ICC (275-4422) * 14700 Alondra Blvd., La Mirada, CA 90638 * www.icc.com