



# Bullet Camera Series

## Hardware Manual

D41A, D42A, E42B, E43B, E47

Ver. 2014/05/05



# Table of Contents

## **Precautions 4**

---

Safety Instructions .....	6
---------------------------	---

## **Introduction 7**

---

List of Models.....	7
Package Contents.....	8
Physical Description .....	9
Mounting Options .....	11

## **Installation Procedures Using the Bundled**

### **Bracket 12**

---

<b>Step 1: Install the Bundled Bracket.....</b>	<b>12</b>
<b>Step 2: Attach the Sunshield .....</b>	<b>13</b>
<b>Step 3: Install the Camera .....</b>	<b>14</b>
<b>Step 4: Waterproof and Connect the Cable .....</b>	<b>15</b>
How to Use the Cable Gland.....	16
How to Use the Conduit Gland.....	19
<b>Step 5: Connect the Cable .....</b>	<b>23</b>
<b>Step 6: Access the Camera Live View.....</b>	<b>23</b>

### **Other Connections 24**

---

How to Connect DI/DO Devices (Optional) .....	24
How to Connect Audio Input / Output Devices (Optional).....	27

### **Adjustments and Accessories 28**

---

<b>How to Install / Remove the Memory Card .....</b>	<b>28</b>
How to Insert the Memory Card .....	28
How to Remove the Memory Card.....	29
<b>Adjust the Viewing Angle and Focus .....</b>	<b>30</b>
<b>How to Reset the Camera.....</b>	<b>31</b>

## Accessing the Camera 32

---

<b>Configure the IP Addresses .....</b>	<b>32</b>
Using DHCP Server to Assign IP Addresses.....	32
Using the Default Camera IP Address.....	34
<b>Access the Camera.....</b>	<b>36</b>

# Precautions

## **Read these instructions**

You should read all the safety and operating instructions before using this product.

## **Heed all warnings**

You must adhere to all the warnings on the product and in the instruction manual. Failure to follow the safety instruction given may directly endanger people, cause damage to the system or to other equipment.

## **Servicing**

Do not attempt to service this video device yourself as opening or removing covers may expose you to dangerous voltage or other hazards. Refer all servicing to qualified service personnel.

## **Trademarks**

All names used in this manual are probably registered trademarks of respective companies.

## **Liability**

Every reasonable care has been taken during the writing of this manual. Please inform your local office if you find any inaccuracies or omissions. We cannot be held responsible for any typographical or technical errors and reserve the right to make changes to the product and manuals without prior notice.

### Federal Communications Commission Statement



This equipment has been tested and found to comply with the limits for a class B digital device, pursuant to Part 15 of the FCC Rules. These limits are designed to provide reasonable protection against harmful interference in a residential installation. This equipment generates, uses, and can radiate radio frequency energy and, if not installed and used in accordance with the instructions, may cause harmful interference to radio communications. However, there is no guarantee that interference will not occur in a particular installation. If this equipment does cause harmful interference to radio or television reception, which can be determined by turning the equipment off and on, the user is encouraged to try to correct the interference by one or more of the following measures:

- Reorient or relocate the receiving antenna.
- Increase the separation between the equipment and receiver.
- Connect the equipment into an outlet on a circuit different from that to which the receiver is connected.
- Consult the dealer or an experienced radio/TV technician for help.

**Warning:** Changes or modifications to the equipment that are not expressly approved by the responsible party for compliance could void the user's authority to operate the equipment.

### European Community Compliance Statement



This product has been tested and found to comply with the limits for Class B Information Technology Equipment according to European Standard EN 55022 and EN 55024. In a domestic environment, this product may cause radio interference in which cause the user may be required to take adequate measures.

## Safety Instructions

---

### **Don't open the housing of the product**

#### **Cleaning**

Disconnect this video product from the power supply before cleaning.

#### **Attachments**

Do not use attachments not recommended by the video product manufacturer as they may cause hazards.

#### **Water and Moisture**

Do not use this video product near water, for example, near a bathtub, washbowl, kitchen sink, or laundry tub, in a wet basement, or near a swimming pool and the like.

### **Don't use accessories not recommended by the manufacturer**

Only install this device in a dry place protected from weather

#### **Servicing**

Do not attempt to service this video product yourself as opening or removing covers may expose you to dangerous voltage or other hazards. Refer all servicing to qualified service personnel.

#### **Damage Requiring service**

Disconnect this video product from the power supply immediately and refer servicing to qualified service personnel under the following conditions.

- 1) When the power-supply cord or plug is damaged
- 2) If liquid has been spilled, or objects have fallen into the video product.
- 3) If the video product has been directly exposed to rain or water.
- 4) If the video product does not operate normally by following the operating Instructions in this manual. Adjust only those controls that are covered by the instruction manual, as an improper adjustment of other controls may result in damage, and will often require extensive work by a qualified technician to restore the video product to its normal operation.

#### **Safety Check**





Upon completion of any service or repairs to this video product, ask the service technician to perform safety checks to determine if the video product is in proper operating condition.

# Introduction

## List of Models

---

This hardware manual contains the following models:

D41A		1MP Bullet with D/N, Adaptive IR, Vari-focal lens
D42A		3MP Bullet with D/N, Adaptive IR, Vari-focal lens
E42B		3MP Bullet with D/N, Adaptive IR, Basic WDR, Vari-focal lens
E43B		5MP Bullet with D/N, Adaptive IR, Basic WDR, Vari-focal lens
E47		1.3MP Bullet with D/N, Adaptive IR, Basic WDR, SLLS, Vari-focal lens

## Package Contents

Camera	Conduit Gland	Cable Gland
		
Washer	Mounting Screw Kit	Sunshield Screw Kit
		
Bracket	Bracket Plate	Sunshield
		
Warranty Card	Quick Installation Guide	
		



## Physical Description

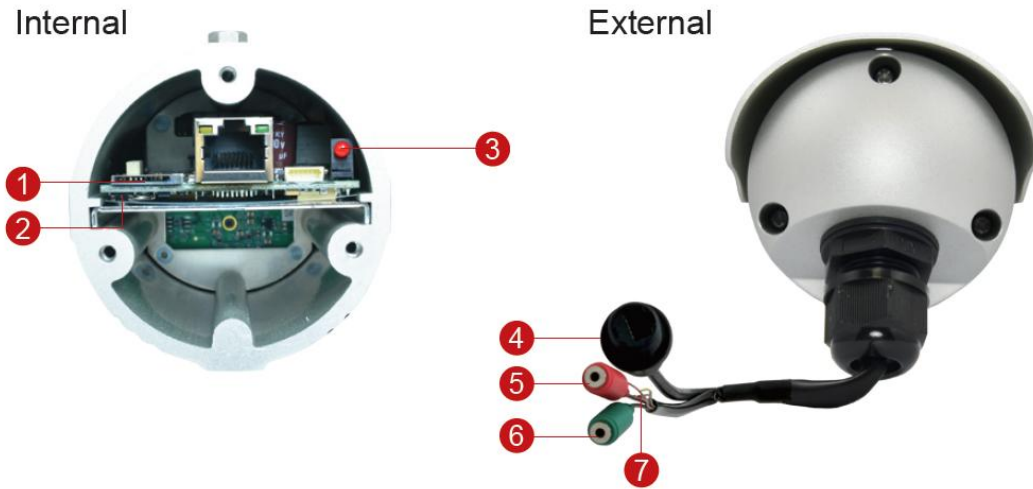





Item		Description
1	Memory Card Slot	Insert a memory card (not included) into this slot for local recording purposes. See <a href="#">How to Install / Remove the Memory Card</a> on page 28 for more information. <b>NOTE:</b> Supports microSDHC and microSDXC cards.
2	Reset Button	Use the Reset Button to reset the camera to its factory default settings. To do the reset, press and hold the Reset button for at least 5 seconds or until the Power LED lights up. When the Power LED lights up again, reset is complete. See <a href="#">How to Reset the Camera</a> on page 31.
3	Power LED	The Power LED lights up when the camera is connected to the power source and goes off once the camera boot-up process is complete. <b>NOTE:</b> For typical use, the power LED is hidden inside the housing and cannot be seen. However, knowing how the power LED works is essential when troubleshooting or doing a reset.
4	Ethernet Port	Connects to a network using a standard Ethernet cable.
5	Audio Input	Connects to audio input devices, such as a microphone with built-in amplifier, etc. <b>NOTE:</b> The microphone must have a built-in amplifier. Connecting an ordinary microphone will dwarf sounds and will result in inaudible recording.
6	Audio Output	Connects to audio output devices, such as a speaker, etc.

Item	Description
7	Digital Input / Output Connects to digital input or output devices, such as an alarm trigger, panic button, etc. Digital Input (DI) and Digital Output (DO) devices are used in applications like motion detection, event triggering, alarm notifications, etc. See <a href="#">How to Connect DI/DO Devices (Optional)</a> on page 24 for information on how to connect DI/DO devices to your camera.

## Mounting Options

In areas with fierce weather conditions, the light bundled bracket can be replaced by a heavy duty outdoor bracket combined with additional mounting accessories.

Below are the optional mounting accessories that you can use with the camera.

Mount Types	Accessories		
Corner Mount	Suitable when mounting the camera on a corner wall.		
	PMAX-1103 	+	PMAX-0402 
Pole Mount	Suitable when mounting the camera on a pole.		
	PMAX-1103 	+	PMAX-0503 

**NOTE:**

- For more information about the mounting solutions and accessories, please check the [Mounting Accessory Selector](http://www.acti.com/mountingselector) in our website (<http://www.acti.com/mountingselector>).
- The above mounting accessories are not included in the package. Contact your sales agents to purchase.

# Installation Procedures Using the Bundled Bracket

## Step 1: Install the Bundled Bracket

---

1. Mark the location of the three (3) screw holes using the bracket plate included in the package.

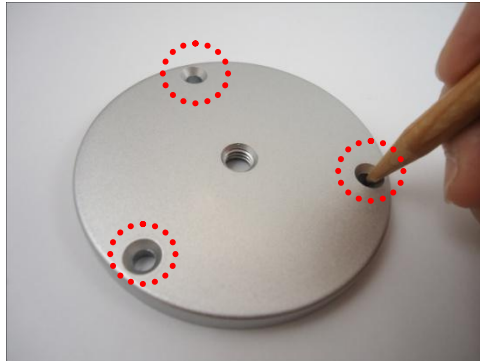

**NOTE:** Depending on the surface where you will install the camera, it may be necessary to drill the holes and use the supplied screw tool.

2. Attach the plate to the surface using the three (3) supplied screws.

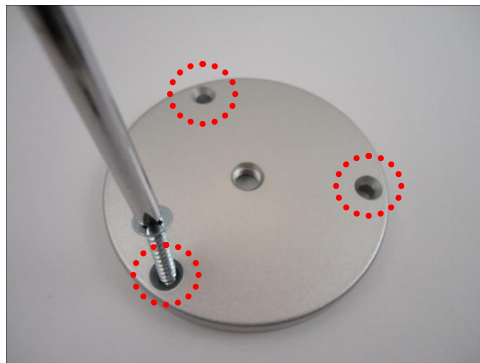

3. Attach the bracket to the plate.



## Step 2: Attach the Sunshield

The use of sunshield is optional if the camera will be installed indoors. However, if the camera will be installed outdoors, attach the sunshield to protect the lens from all types of weather and lighting conditions.

1. Loosely secure the supplied screws and washers to attach the sunshield.



2. Slide to adjust the sunshield to cover the lens as far as possible but out of the camera's live view.



3. Tighten the screws to fix the position of the sunshield.

## Step 3: Install the Camera

1. If necessary, install a memory card to the camera. See [How to Insert the Memory Card](#) on page 28 for more information.
2. Depending on how you want to install the camera, attach the camera to the bracket through one of the two (2) holes below:



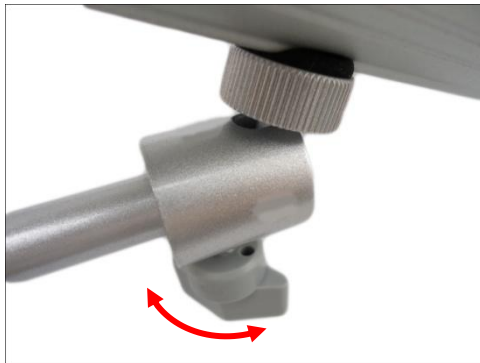

3. Adjust the camera viewing angle and tighten the knob to fix the camera position.



## Step 4: Waterproof and Connect the Cable

The camera and the pre-installed network cable, “pigtail”, are resistant to salt, water, weak acid, alcohol, oil, grease and other common solvents. However, users must ensure that the cable connection and the network side cable itself are also protected from different environmental factors.

For Ethernet connection, there are two waterproofing methods.

Bundled Accessory	Description
<p data-bbox="236 645 389 674">Cable Gland</p> 	<p data-bbox="651 645 1337 819">Use this solution when connecting an Exterior-grade Ethernet cable between the camera and a Power-over-Ethernet (PoE) switch or injector. See <a href="#">How to Use the Cable Gland</a> on page 16.</p>
<p data-bbox="236 1032 411 1061">Conduit Gland</p> 	<p data-bbox="651 1032 1337 1256">Use this solution when connecting a standard indoor Ethernet cable between the camera and a Power-over-Ethernet (PoE) switch / injector. A flexible conduit (trade size 1/2”) is required to house the Ethernet cable. See <a href="#">How to Use the Conduit Gland</a> on page 19.</p> <p data-bbox="651 1285 1294 1364"><b>NOTE:</b> The flex conduit is not included in the package and must be purchased separately.</p>

Audio and digital input/output devices can be connected to the camera, for more information, see [Other Connections](#) on page 24.

### How to Use the Cable Gland

This section describes how to waterproof the cable-out or “pigtail” of the camera using the bundled cable gland. An exterior-grade Ethernet cable is required. The camera may or may not have to be installed first before doing the cable connections (see related installation procedures for details).

Before connection, prepare the following materials:

Cable Gland (included in the camera package)	Exterior-Grade Ethernet Cable (not included in the package)
	 <p><b>NOTE:</b> Exterior-grade cables are already waterproof. <i>Not included in the package.</i></p>
Washer (included in the camera package)	
	

Perform the following to waterproof the “pigtail” using the cable gland:

1. Disassemble the cable gland as shown below:

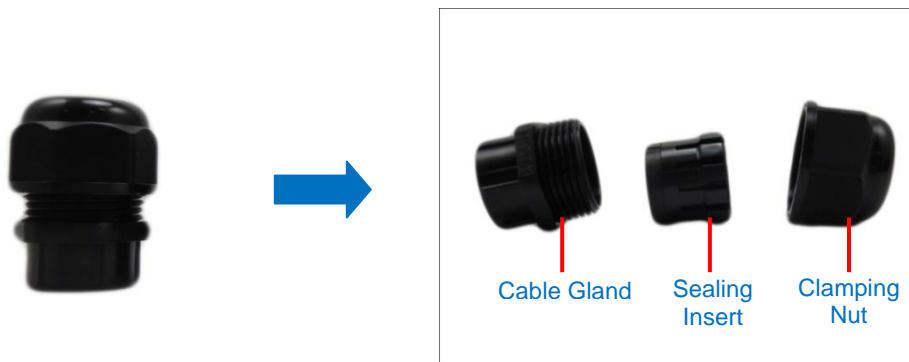



2. Insert the clamping nut into the Ethernet cable.



3. Insert the sealing insert with claw.



4. Insert the gland body into the Ethernet cable.



5. On the "pigtail" side, insert the washer into the "pigtail".

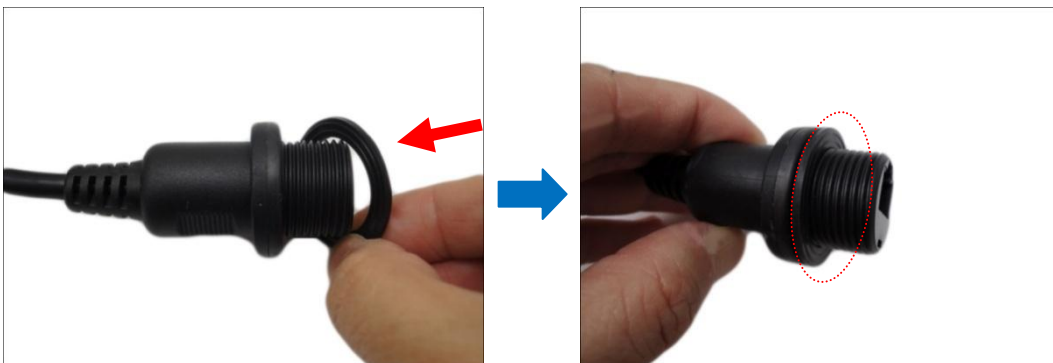

- Connect the Ethernet cable connector to the “pigtail” connector.



- Attach the gland body to the “pigtail”.

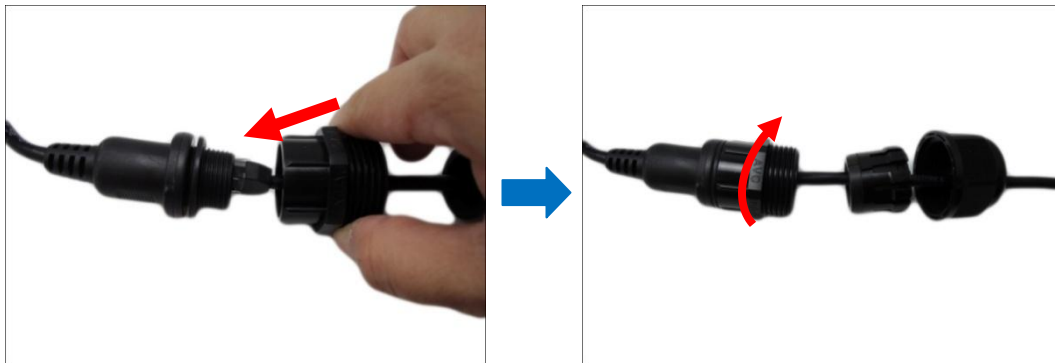

**NOTE:** Make sure the gland body is tightly attached to the “pigtail” and the washer is secured between them.

- Insert the sealing insert into the cable gland body and then attach the clamping nut to complete the cable solution.

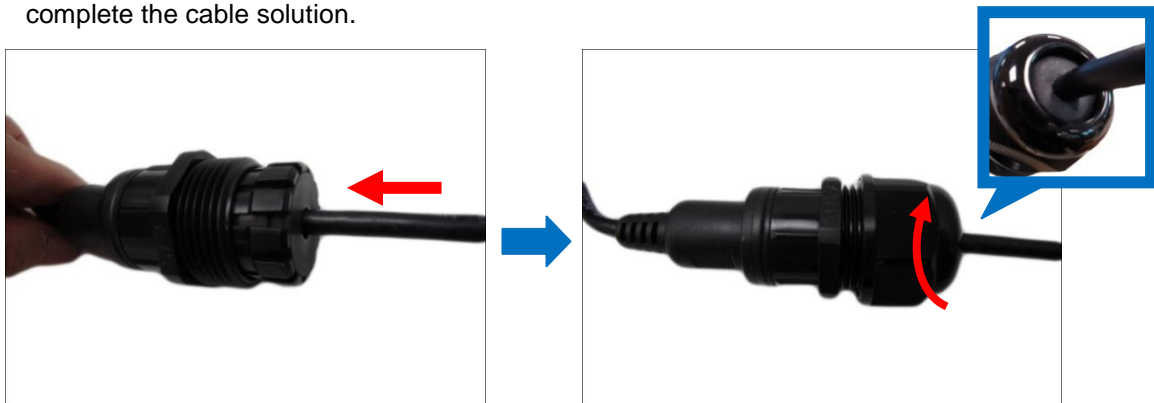

**NOTE:** Make sure the clamping nut is tightly attached to the cable gland body and the sealing insert is squeezed tightly.

### How to Use the Conduit Gland

This section describes how to waterproof the cable-out or “pigtail” of the camera using the bundled conduit gland and flexible conduit. This is the recommended solution if an exterior-grade Ethernet cable is not available.

Before connection, prepare the following materials:

<b>Conduit Gland</b> (included in the camera package)	<b>Flexible Conduit</b> 1/2" Trade size (not included in the package)
	 <p><b>NOTE:</b> Not included in the package.</p>
<b>Washer</b> (included in the camera package)	<b>Ethernet Cable</b> CAT 5 or CAT 6 (not included in the package)
	

Perform the following to waterproof the “pigtail” using the conduit gland:

1. Disassemble the conduit gland as shown below:

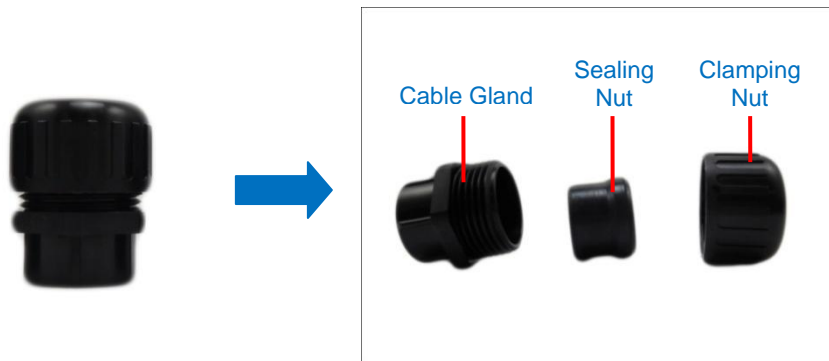

2. Pull the Ethernet cable through the flex conduit. Leave enough length of the cable outside the flex conduit.



3. Insert the clamping nut through the flex conduit.

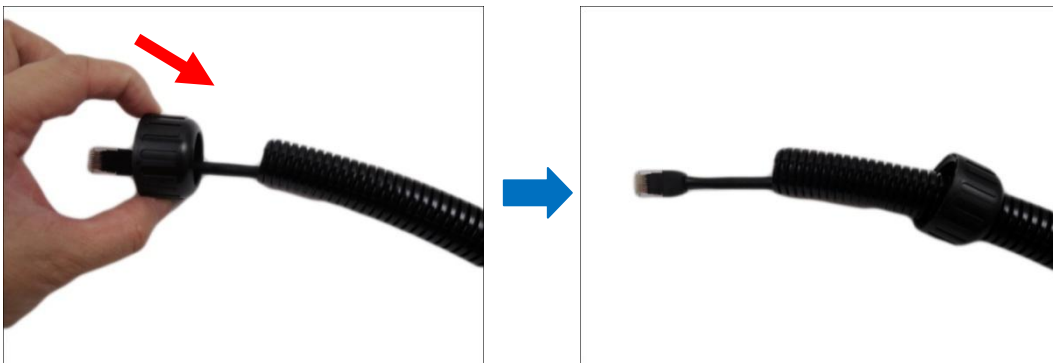

4. Insert the sealing nut and fix it at the end of the flex conduit.

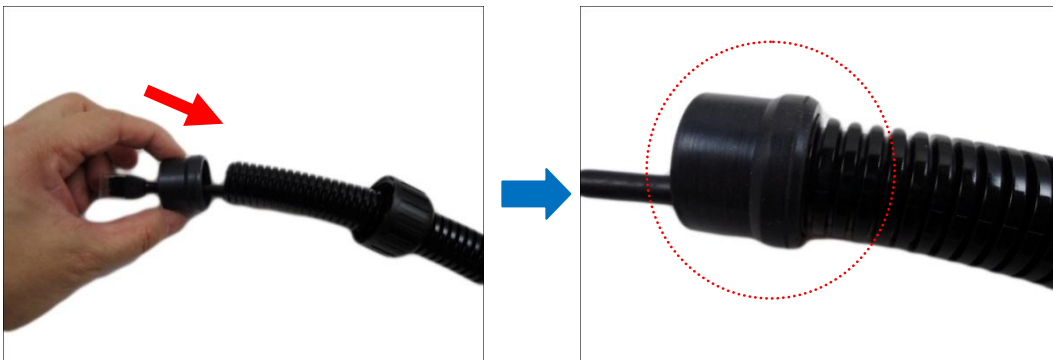

5. Insert the gland body into the Ethernet cable.



6. On the “pigtail” side, insert the washer into the “pigtail”.

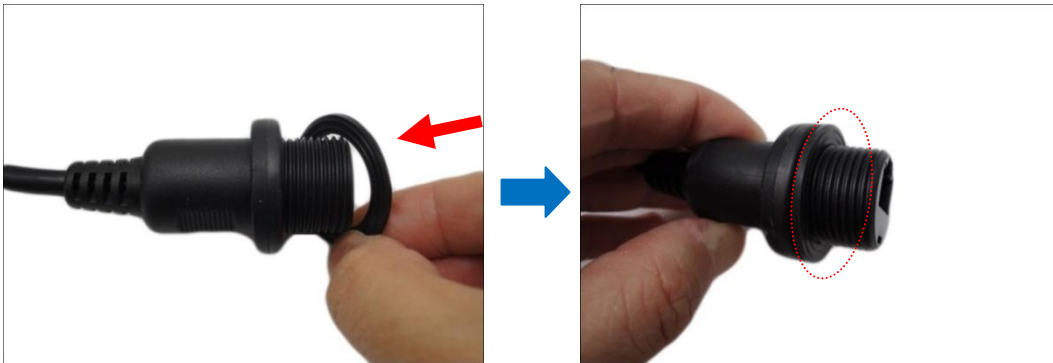

7. Connect the Ethernet cable connector to the “pigtail” connector.



8. Attach the gland body to the “pigtail”.

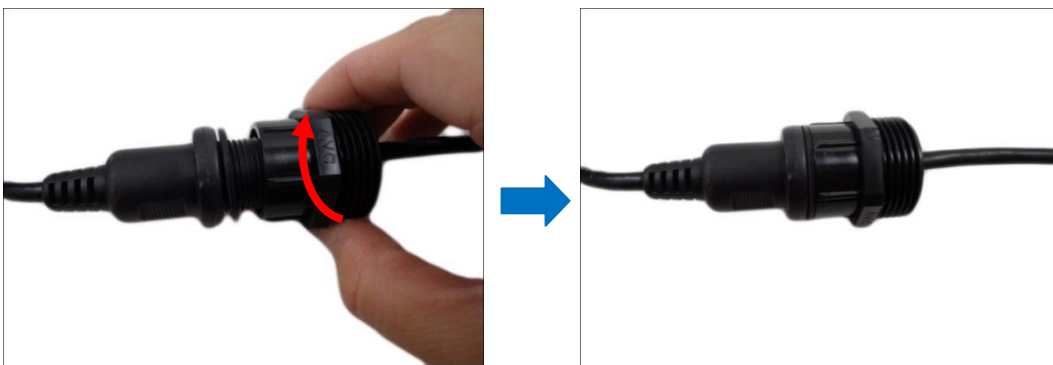

**NOTE:** Make sure the gland body is tightly attached to the “pigtail” and the washer is secured between them.

9. Push the flex conduit and insert the sealing nut into the gland body.

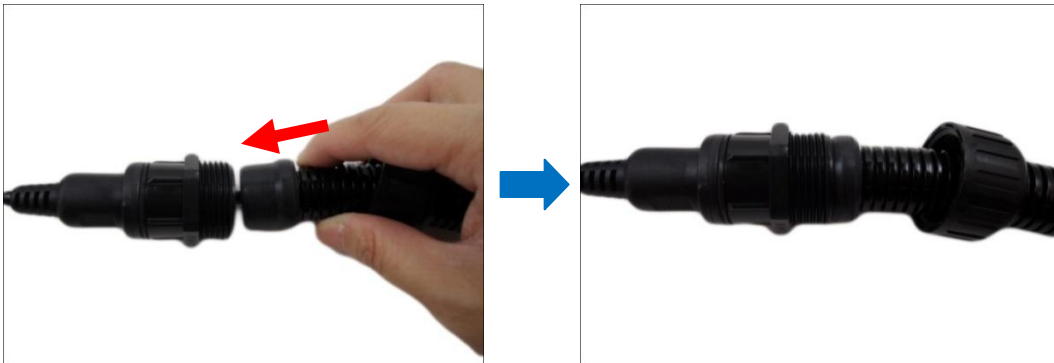

**NOTE:** Make sure the clamping nut is tightly attached to the cable gland body and the sealing insert is squeezed tightly.

10. Attach the clamping nut to complete the cable solution.



## Step 5: Connect the Cable

Connect the other end of the network cable to a switch or injector. Then, connect the switch or injector to a network, PC, and a power source. See Power-over-Ethernet (PoE) connection example below.

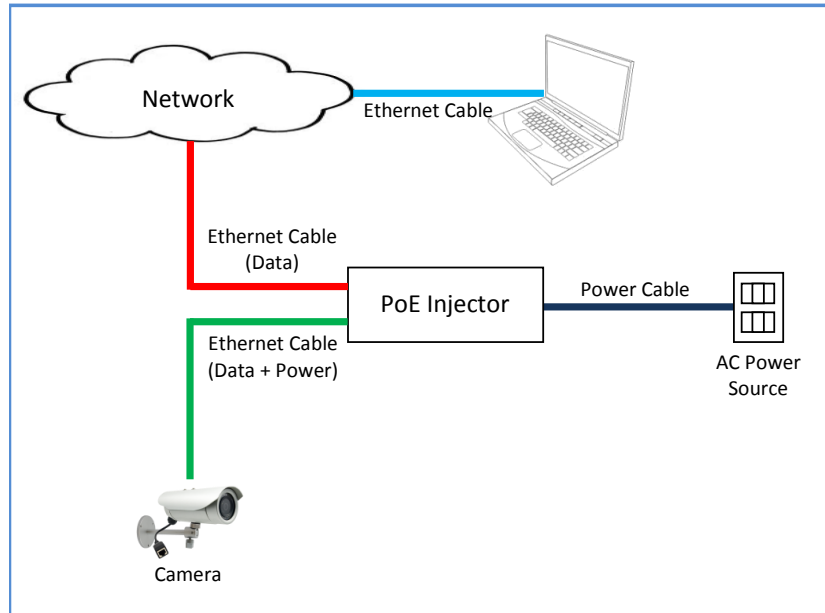

## Step 6: Access the Camera Live View

See [Accessing the Camera](#) on page 32 for more information on how to access the Live View of the camera.

## Other Connections

This section describes the procedures in connecting Digital Input and Output (DI/DO) and Audio Input and Output devices. The use of these devices, however, is optional.

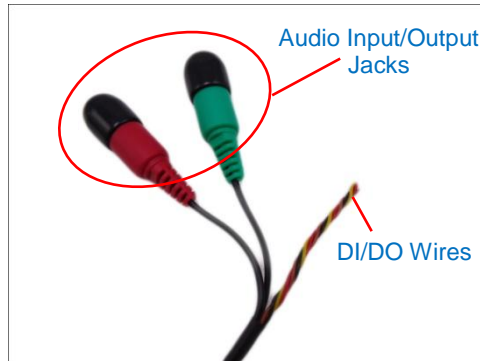

**NOTE:** If these connectors will not be used, leave the rubber caps on and the wires twisted together to ensure cables remain waterproof and eliminate short-circuit hazards.

### How to Connect DI/DO Devices (Optional)

Digital Input (DI) devices can be used to notify the camera about an activity in the camera site. DI can be triggers of events. For example, you can connect a “panic button” to the camera; as such when the panic button is pressed, the alarm signal will be sent through the camera. Other common DI device applications are emergency button, smoke detector, passive infrared sensor, etc.

Digital Output (DO) devices are external devices that are activated by the camera upon an event inside the camera. For example, you can connect an “alarm horn” to the camera; as such when an event occurs inside the camera (e.g. detected intruder), the alarm horn will sound. Other common DO device applications are motion-triggered lights, electric fence, magnetic door locks, etc.



### Understanding the DI/DO Cables

You can connect up to one (1) DI and one (1) DO device to your camera.

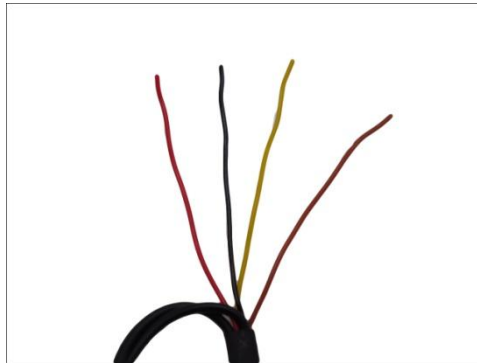

Digital Input Cables	Cable Color	Wiring Connection
Ground Pin ( <b>GND</b> )	Black	To connect a digital input device, map the digital input device wires to <b>DI</b> (red) and <b>GND</b> (black) wires.
Digital Input ( <b>DI</b> )	Red	

Digital Output Cables	Cable Color	Wiring Connection
12V ( <b>12V</b> )	Yellow	To connect digital output devices, map the digital output device wires to <b>12V</b> (yellow) and <b>DO</b> (brown) wires.
Digital Output ( <b>DO</b> )	Brown	

The table below shows the DI/DO connection specifications:

Device			
DI	Connection design		TTL - compatible logic levels
	Voltage	To trigger (low)	Logic level 0: 0V ~ 0.4V
		Normal (high)	Logic level 1: 3.1V ~ 30V
	Current		10mA ~ 100mA
DO	Connection design		Transistor (Open Collector)
	Voltage & Current		< 24V DC, < 50mA

### Typical Connection

Based on these specifications, if the DI device has a voltage of 0V ~ 30V or the DO device has a voltage of < 24V (< 50mA), then the camera can supply internal power to these devices and there is no need to connect the DI/DO device to an external power source.

In this case, wire connection to Pins 1 to 4. Use the **DIO GND** and **DI** pins to connect a DI device and use the **DIO PW** and **DO** pins to connect a DO device. See wiring scheme below:

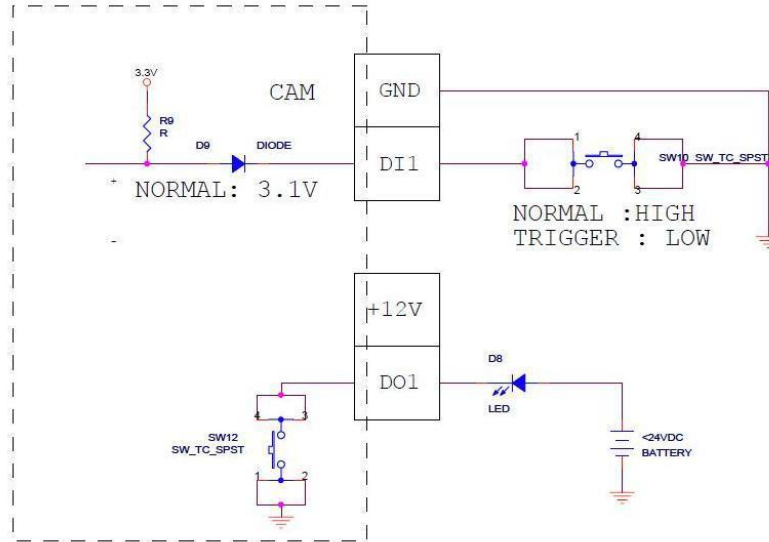

### High Voltage DO Device Connection

Even though the camera provides 12V power, this may not be enough for some high voltage DO devices, such as a ceiling light or a motor that opens or closes a gate. In this case, there is a need to connect an external relay. See wiring scheme below:

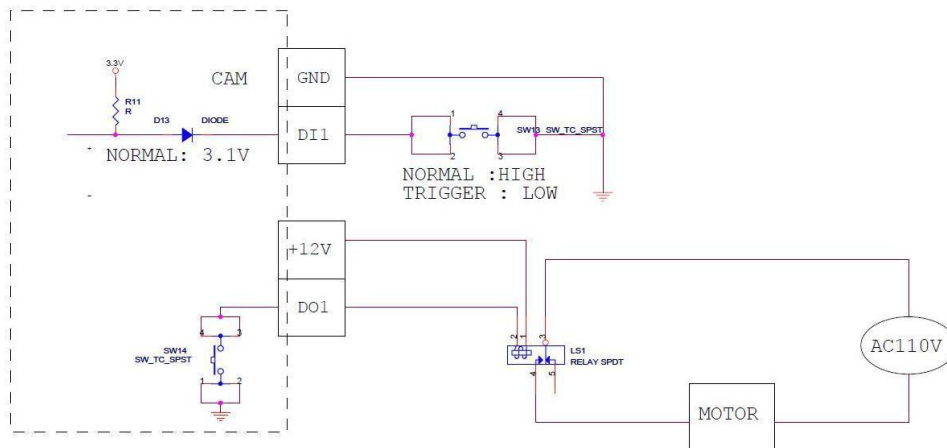

Note that when choosing an appropriate relay, please refer to its specifications and make sure they match the above design. The triggering circuit voltage has to be around 12V DC and the switch-controlled circuit voltage has to match the external power supply (e.g. 110V AC or 220V AC).

The illustration below is a graphic example of connecting a relay to a high voltage DO device.

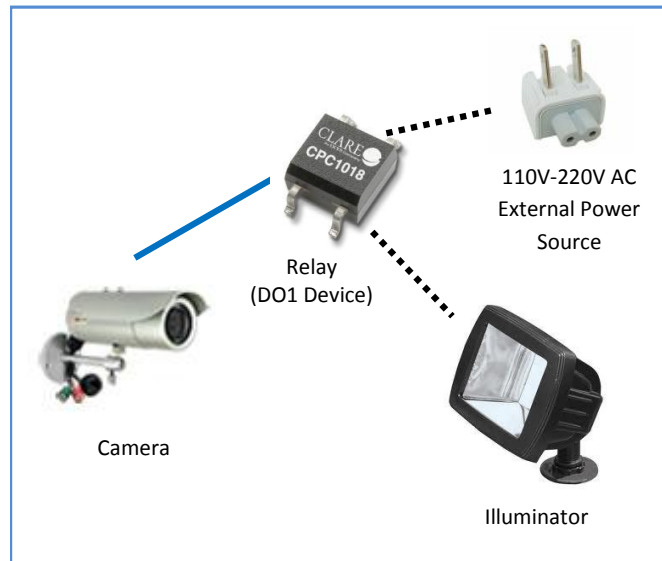

**NOTE:** For more information on DI/DO connections, please refer to the Knowledge Base article *All about Digital Input and Digital Output* downloadable from the link below ([http://www.acti.com/kb/detail.asp?KB\\_ID=KB20091230001](http://www.acti.com/kb/detail.asp?KB_ID=KB20091230001)).

## How to Connect Audio Input / Output Devices (Optional)

If using an audio input device, such as a microphone with a built-in amplifier, connect the device to the **Audio Input** jack (RED) of the camera. If using an audio output device, such as a speaker, connect the device to the **Audio Output** jack (GREEN) jack of the camera.

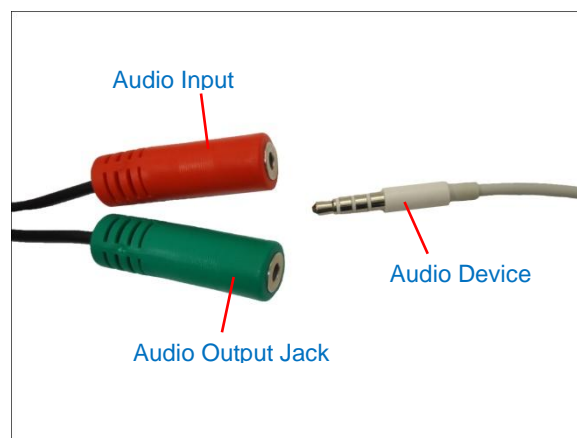

**Note:** Make sure that the connected audio input device has a built-in amplifier. Connecting an ordinary microphone will dwarf sounds and will result in inaudible recording.

# Adjustments and Accessories

This section describes the procedures on installing a memory card and resetting the camera.

## How to Install / Remove the Memory Card

The camera supports local video recording or saving of snapshots to a memory card.

**NOTE:** Supports microSDHC and microSDXC cards.

### How to Insert the Memory Card

1. Loosen the three (3) screws to detach the back cover.

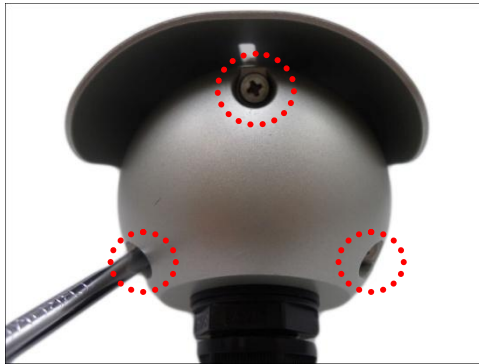

**NOTE:** A cable is connected inside the camera; do not abruptly pull the back cover.

2. Insert the memory card into the card slot with the metallic contacts facing down and push the card until it clicks into place.

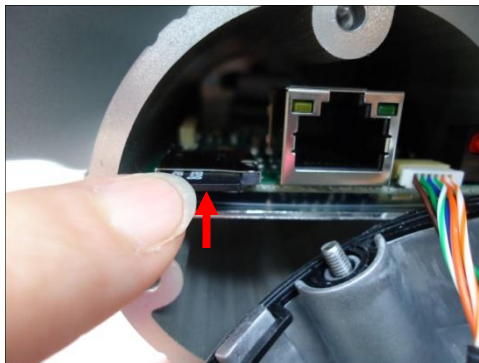

3. When done, ensure the rubber seal is aligned and attached to the back cover and then close the back cover by tightening the three (3) screws.

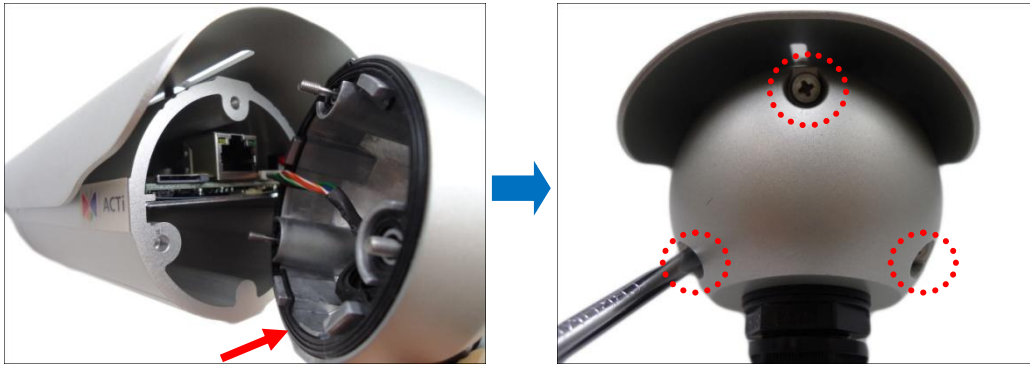

**CAUTION:** Make sure the rubber seal is properly attached and the back cover is closed to ensure water or dust cannot enter the camera.

### How to Remove the Memory Card

In case there is a need to remove the card, make sure to access the camera Web Configurator to safely “unmount” the card first (see the camera Firmware manual for more information).

Once unmounted from the firmware, push the card to eject it from the slot.

## Adjust the Viewing Angle and Focus

The camera already comes pre-focused when taken out of the box. If there is a need to change the viewing angle and focus, follow the steps below to adjust them.

1. Open the front cover.



2. Loosen the lever screws. Based on the live view, move the levers to adjust the focus and viewing angle of the target area .

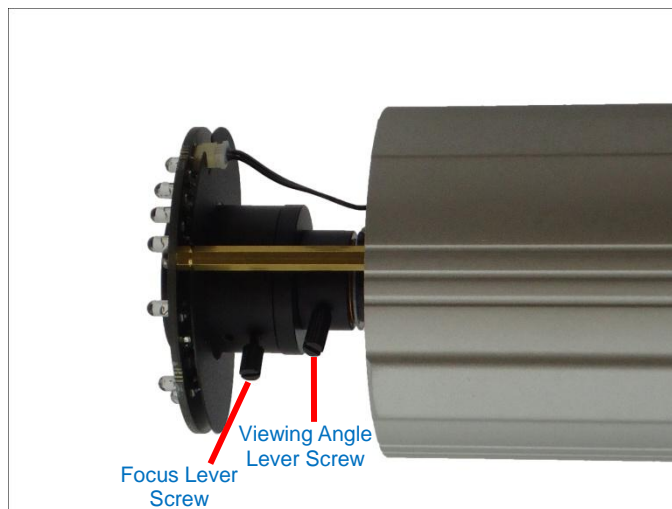

3. When done, tighten back the lever screws to fix their position.
4. Close the front cover.

**CAUTION:** The front cover must be tightly closed to ensure water or dust does not go through any opening.

## How to Reset the Camera

In case there is a need to reset the camera to its default factory settings, do the following procedures while the camera is powered on.

1. Loosen the three (3) screws securing the back cover.

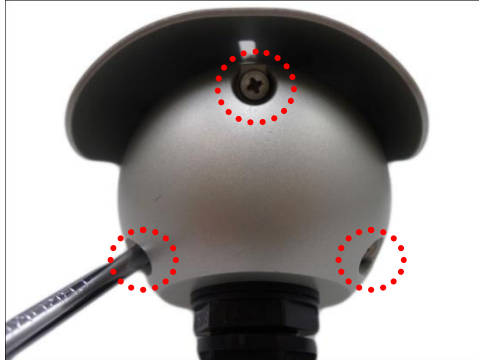

**NOTE:** A cable is connected inside the camera; do not abruptly pull the back cover.

2. Using a pointed object, such as the tip of a pen, press and hold the Reset button for at least 5 seconds or until the Power LED lights up, to reset the camera.



3. When done, ensure the rubber seal is aligned and attached to the back cover and then close the back cover by tightening the three (3) screws.

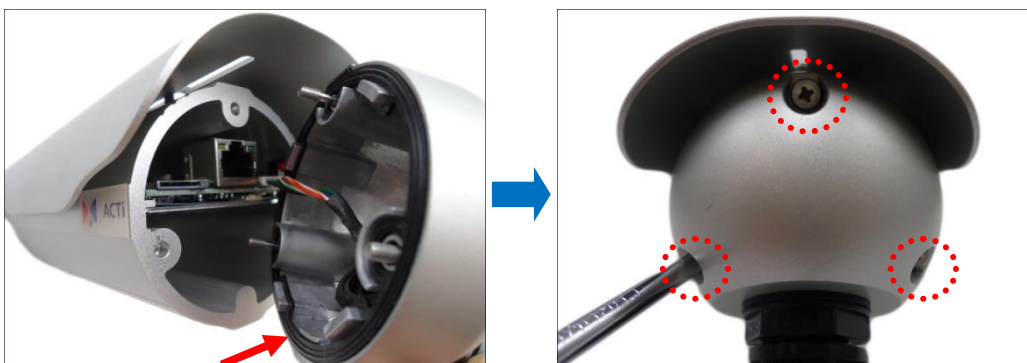

**CAUTION:** Make sure the rubber seal is properly attached and the back cover is closed to ensure water or dust cannot enter the camera.

# Accessing the Camera

## Configure the IP Addresses

In order to be able to communicate with the camera from your PC, both the camera and the PC have to be within the same network segment. In most cases, it means that they both should have very similar IP addresses, where only the last number of the IP address is different from each other. There are 2 different approaches to IP Address management in Local Area Networks – by DHCP Server or Manually.

### Using DHCP Server to Assign IP Addresses

If you have connected the computer and the camera into the network that has a DHCP server running, then you do not need to configure the IP addresses at all – both the camera and the PC would request a unique IP address from DHCP server automatically. In such case, the camera will immediately be ready for the access from the PC. The user, however, might not know the IP address of the camera yet. It is necessary to know the IP address of the camera in order to be able to access it by using a Web browser.

**The quickest way to discover the cameras in the network** is to use the simplest network search, built in the Windows system – just by pressing the “Network” icon, all the cameras of the local area network will be discovered by Windows thanks to the UPnP function support of our cameras.

In the example below, we successfully found the camera that we had just connected to the network.

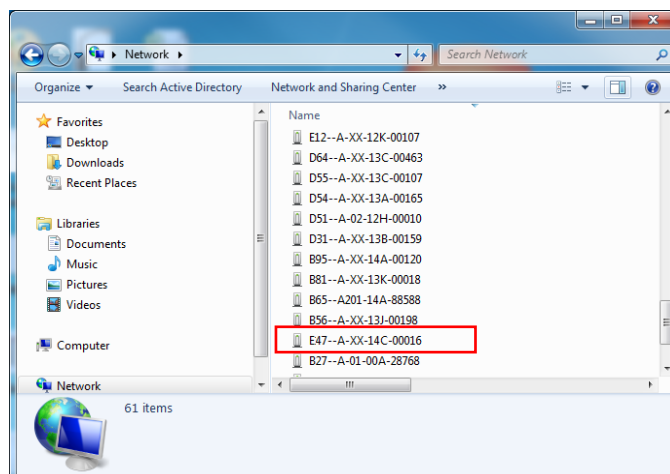

By double-clicking with the left mouse on the camera model, it is possible to automatically launch the default browser of the PC with the IP address of the target camera filled in the address bar of the browser already.



If you work with our cameras regularly, then **there is even a better way to discover the cameras in the network** – by using **IP Utility**. The IP Utility is a light software tool that can not only discover the cameras, but also list lots of valuable information, such as IP and MAC addresses, serial numbers, firmware versions, etc, and allows quick configuration of multiple devices at the same time.

The IP Utility can be downloaded for free from [http://www.acti.com/IP\\_Utility](http://www.acti.com/IP_Utility)

With just one click, you can launch the IP Utility and there will be an instant report as follows:

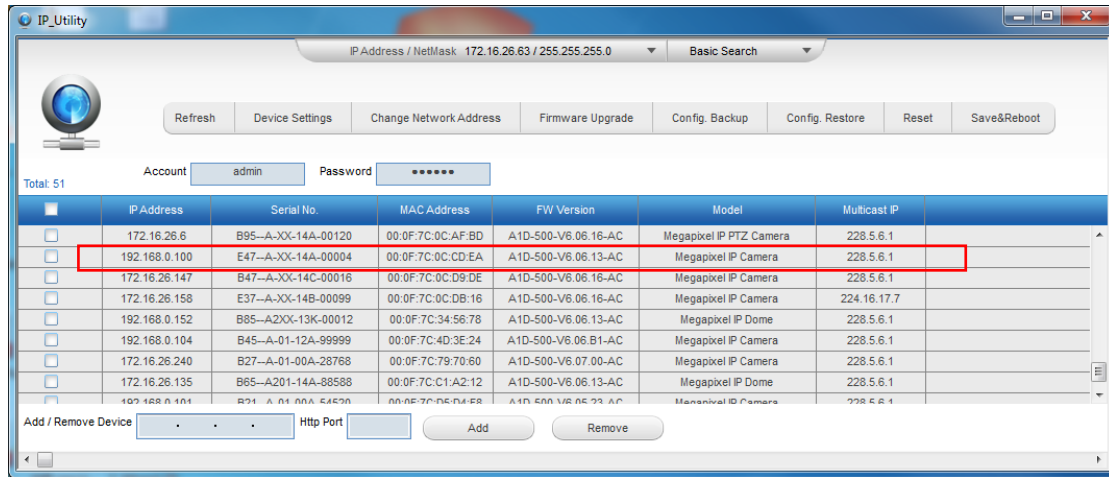

You can quickly see the camera model in the list. Click on the IP address to automatically launch the default browser of the PC with the IP address of the target camera filled in the address bar of the browser already.

## Using the Default Camera IP Address

If there is no DHCP server in the given network, the user may have to assign the IP addresses to both PC and camera manually to make sure they are in the same network segment.

When the camera is plugged into network and it does not detect any DHCP services, it will automatically assign itself a default IP:

**192.168.0.100**

Whereas the default port number would be **80**. In order to access that camera, the IP address of the PC has to be configured to match the network segment of the camera.

### Manually adjust the IP address of the PC:

In the following example, based on Windows 7, we will configure the IP address to **192.168.0.99** and set Subnet Mask to **255.255.255.0** by using the steps below:

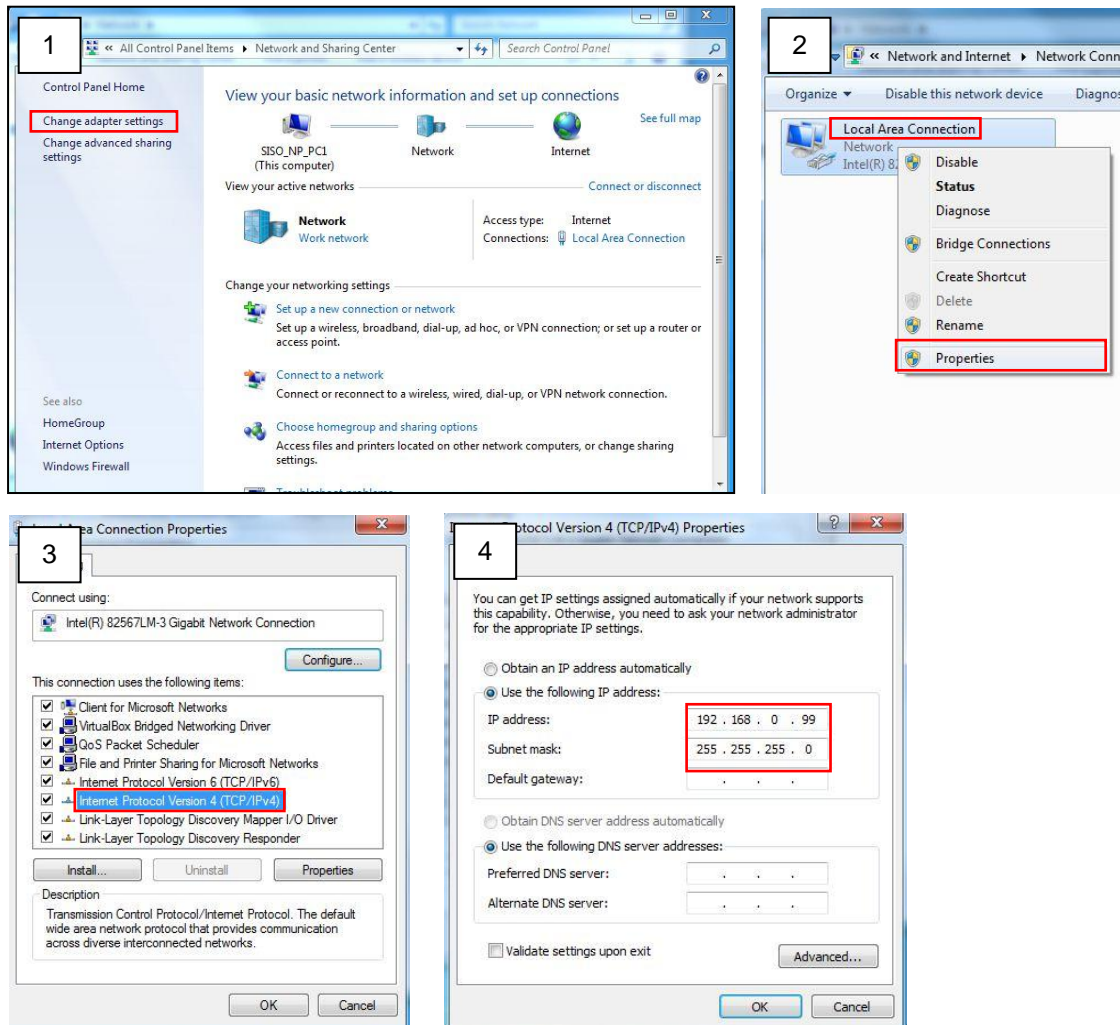

**Manually adjust the IP addresses of multiple cameras:**

If there are more than one camera to be used in the same local area network and there is no DHCP server to assign unique IP addresses to each of them, all of the cameras would then have the initial IP address of **192.168.0.100**, which is not a proper situation for network devices – all the IP addresses have to be different from each other. The easiest way to assign cameras the IP addresses is by using **IP Utility**:

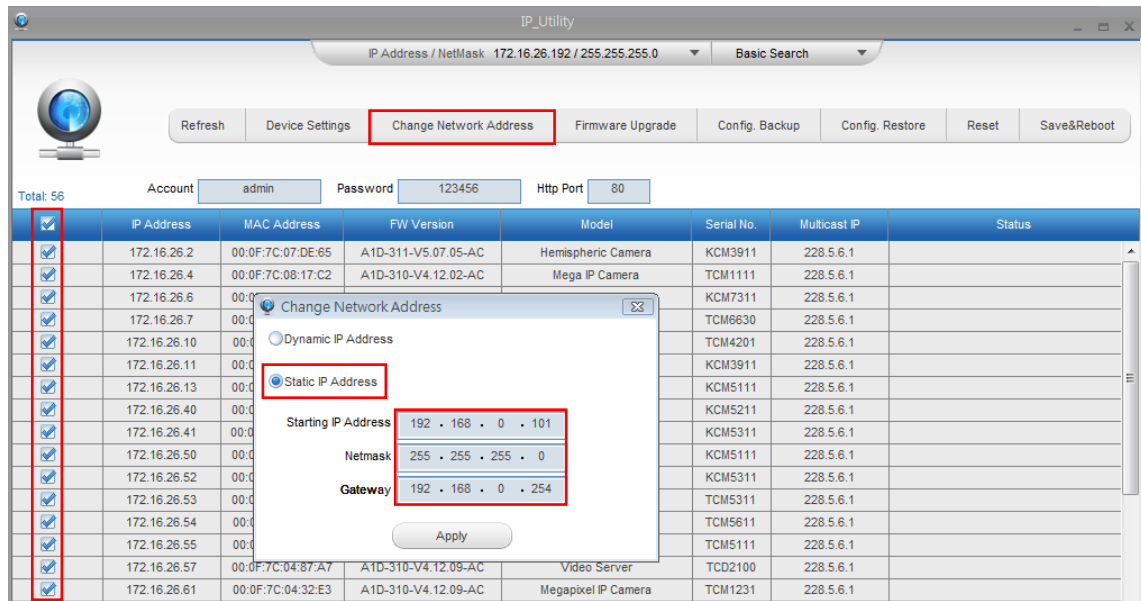

With the procedure shown above, all the cameras will have unique IP addresses, starting from 192.168.0.101. In case there are 20 cameras selected, the last one of the cameras would have the IP 192.168.0.120.

Later, by pressing the “Refresh” button of the IP Utility, you will be able to see the list of cameras with their new IP addresses.

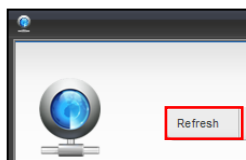

Please note that it is also possible to change the IP addresses manually by using the Web browser. In such case, please plug in only one camera at a time, and change its IP address by using the Web browser before plugging in the next one. This way, the Web browser will not be confused about two devices having the same IP address at the same time.

## Access the Camera

Now that the camera and the PC are both having their unique IP addresses and are under the same network segment, it is possible to use the Web browser of the PC to access the camera.

You can use **any of the browsers** to access the camera, however, the full functionality is provided only for **Microsoft Internet Explorer**.

The browser functionality comparison:

Functionality	Internet Explorer	Other browsers
Live Video	Yes	Yes*
Live Video Area Resizable	Yes	No
PTZ Control	Yes	Yes
Capture the snapshot	Yes	Yes
Video overlay based configuration (Motion Detection regions, Privacy Mask regions)	Yes	No
All the other configurations	Yes	Yes

\* When using non-Internet Explorer browsers, free third-party software plug-ins must be installed to the PC first to be able to get the live video feed from the camera:

Browser	Required Plug-In
Safari	QuickTime ( <a href="http://www.apple.com/quicktime/download/">http://www.apple.com/quicktime/download/</a> )
Other non-Internet Explorer browsers	Basic VLC Media Player ( <a href="http://www.videolan.org">http://www.videolan.org</a> )

**Disclaimer Notice:** The camera manufacturer does not guarantee the compatibility of its cameras with QuickTime or VLC Player – since these are third party softwares. The third parties have the right to modify their utility any time which might affect the compatibility. In such cases, please use Internet Explorer browser instead.

When using Internet Explorer browser, the ActiveX control for video stream management will be downloaded from the camera directly – the user just has to accept the use of such control when prompted so. No other third party utilities are required to be installed in such case.

The following examples in this manual are based on Internet Explorer browser in order to cover all functions of the camera.

Assuming that the camera's IP address is **192.168.0.100**, you can access it by opening the Web browser and typing the following address into Web browser's address bar:

**http://192.168.0.100**

Upon successful connection to the camera, the user interface called **Web Configurator** would appear together with the login page. The HTTP port number was not added behind the IP address since the default HTTP port of the camera is 80, which can be omitted from the address for convenience.

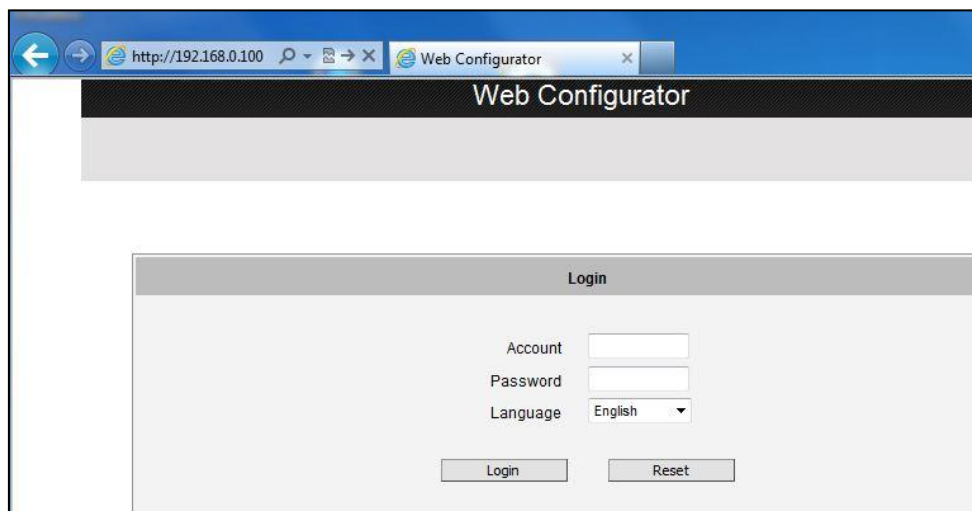

Before logging in, you need to know the factory default Account and Password of the camera.

Account: **Admin**

Password: **123456**

For further operations, please refer to the **Firmware User Manual**.



Copyright © 2014, ACTi Corporation All Rights Reserved

7F, No. 1, Alley 20, Lane 407, Sec. 2, Ti-Ding Blvd., Neihu District, Taipei, Taiwan 114, R.O.C.

TEL : +886-2-2656-2588    FAX : +886-2-2656-2599

Email: [sales@acti.com](mailto:sales@acti.com)